



Main Catalogue



Extended management of Bals Elektrotechnik GmbH & Co. KG: Hubertus Fischer, Wolfgang Bals, Johannes Ramm und Piotr Komor (from left to right).

For over 60 years we have been producing CEE plug and connectors for the world market. That means quality you can always rely on. Our products prove themselves around the globe, in the most diverse applications. „Made in Germany“ stands for a quality standard that offers you the highest level of safety. We are very pleased about your interest in our company. We are proud of our entire portfolio, which you will find in this catalog. Do you have special wishes or requirements? We are happy to advise you and find individual solutions for you.

Wolfgang Bals
Managing Director

Johannes Ramm
Managing Director
Finance & Controlling

Hubertus Fischer
Production & Supply Chain

Piotr Komor
CTO / CCO International business

We ask you to indicate our reference numbers and quantity packaging on all your purchase orders in order to facilitate an easy procedure of the order.
Return shipments based on wrong placed orders effects a tremendous procedure and costs and therefore in such cases we are obliged to apply a handling charge.
Weights, dimensions, technical details and sketches are carefully issued (error excepted) but not obligatory on deliveries. For technical reasons our products are subject to modification continuously due to creative, design and technical progress.

Information

About us	4 - 9
Our brands	10 - 17
Technical information	18 - 31



Sockets

Surface mounting socket outlets	36 - 45
Combined surface mounting socket outlets	46 - 59
Surface mounting socket outlets, chemically resistant	60 - 63
Panel mounting socket outlets	64 - 77
Accessories for sockets	78 - 79



Plugs and connectors

Plugs	84 - 86
Inlets	87 - 101
Phase inverters, adapters and phase sequence indicators	102 - 104
Connectors	105 - 107
Accessories for plugs and connectors	108



Domestic plugs and sockets

Panel mounting socket outlets	118 - 120
Surface mounting socket outlets	121
Plugs and inlets	121 - 122
Connectors	122 - 123
Extension leads	123



Combinations

Surface mounting combinations	127 - 154
Mobile combinations	156 - 170
Hanging combinations	171 - 176
Bollards	177 - 179
Accessories	180 - 183

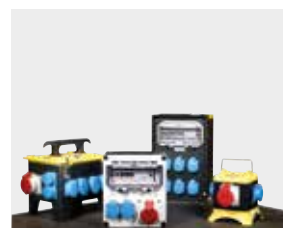

Special plugs and sockets

7-pole	188 - 191
Special grounding position 1h	192 - 194
Extra-low voltage	195 - 197
DC and 5h	198 - 202
Plugs and sockets above 125A	203



Plugs and sockets for special fields of application

Reefer container plugs and sockets	209 - 211
Plugs and sockets for military applications	213 - 221
Event technology	223 - 226
Camping plugs and sockets	228 - 231

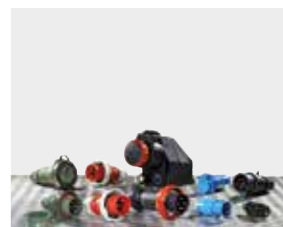

Supplementary products

Plugs and sockets with screw terminals / TLS-series	236 - 239
Empty enclosures and operating windows	240 - 241



General Terms and Conditions, numerical table of contents	242 - 257
---	-----------



About half a century competence and experience

Bals stands worldwide as a quality brand for innovation, reliability and service. For more than 60 years, we have been producing CEE plugs and connectors for the world markets. From day one we have focussed on the highest level of quality "Made in Germany".

Our factories in Kirchhundem-Albaum and Freiwalde have highly skilled and motivated teams, the very latest manufacturing facilities



and a highly efficient logistics system.

Our product portfolio ranges from plugs, phase inverters, connectors, sockets outlets and combinations units to charging plugs and sockets for electrical vehicles. Numerous certifications from German and foreign certification institutes, as well as registered designs and patents, document the high technical standard of our products.

Two modern factories a consistent quality standard

From the beginning the headquarters of our company is located in Kirchhundem-Albaum (North-Rhine-Westphalia). Product development, marketing and sales, as well as administration are located here. In addition, plug and socket systems and special products are manufactured in the Kirchhundem-Albaum factory. The factory in Freiwalde (Brandenburg), built in 1994 and expanded many times since, has state-of-the-art production facilities for fully-automatic manufacturing of unique CEE plugs and connectors as well as a highly-effective logistics centre.

CEE plugs and connectors for the world market

As an independent, medium-sized, family-owned company, we produce standardised industrial plugs and sockets acc. to IEC 60309 1-2 as well as plug and socket systems, distributors and components for the infrastructure of electrical vehicles. We set new technical standards with innovations and ground-breaking, partially patented new developments such as MULTI-GRIP or QUICK-CONNECT. The export rate in excess of 50 percent shows: Our solutions are highly valued around the world. Our products are sold in more than 80 countries. Subsidiaries and exclusive partners in strategically important countries only sell our products.

Customer proximity: You can rely on us

Always close to the customers. For us, this is no empty phrase but reality. Flexibility, customer orientation and the ability to quickly respond to short-term requirements are a matter of course for us. For this reason, integrated production - from the product idea and design to tool making and production to the shipment of the products - is optimised for short processing paths and the fastest response times.



People make the difference

200 employees, who are dedicated and tightly connected to the company, have only one goal: to satisfy you, our customers, one hundred percent. This applies to the highest of quality standards



that we apply to our product and also for made-to-measure service and personal contact from person to person.

Our responsibility to the highest quality

Quality does not permit any compromise. This has always been the maxim at Bals. The ISO-9001-certified production process in all factories ensures the well-known high product quality. This proof of quality is reflected in patents, certificates from German and foreign testing institutes, as well as the specification of Bals products by highly renowned companies. Innovation is an important quality benchmark for us. This way, we are always setting new standards with intelligent solutions that bring the user sustainable advantages.

Our responsibility to the environment

We know and love our region. Maintaining and protecting this unique landscape for future generations is important to us. Production that saves as many resources as possible, the highest environmental standards and continual enhancement of our ecological efficiency at all levels are a matter of course for us. Every individual employee at Bals is aware of this responsibility to people and nature.

Our responsibility to people and the region

As a family-owned company, we are well aware of our special responsibility. We keep jobs safe, encourage the development of every individual and are loyal to our sites which we care for and permanently develop in the long term. Thinking about the future is also important to us: For this reason, we create qualified training positions in a wide variety of professional areas each year. We support numerous local meetings and events and employ an above average number of people with handicaps.

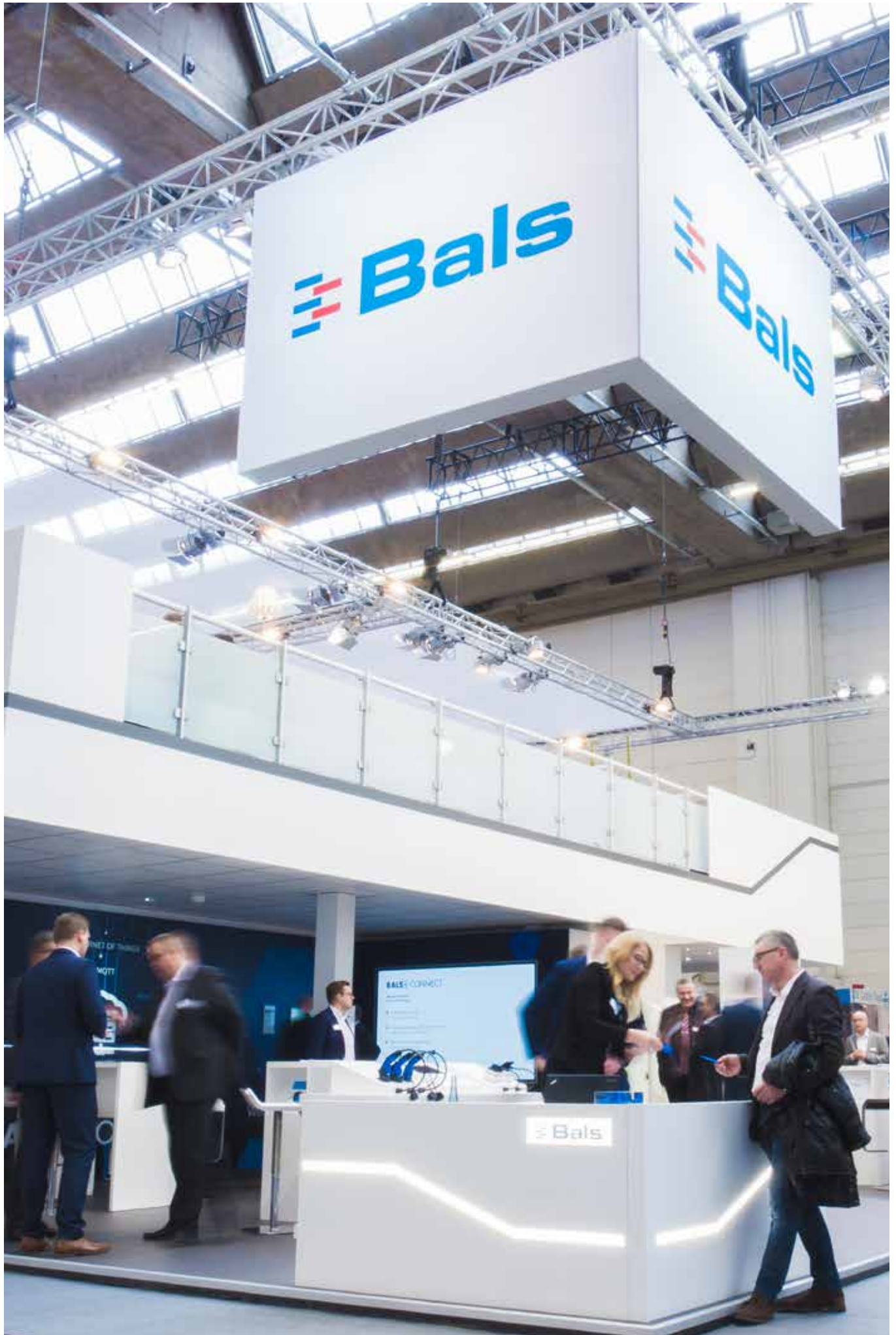

Proximity to customers is extremely important to us

We see ourselves as a partner for our customers and consider trust and continual dialogue to be extremely valuable. At the world's leading trade fairs, at conventions or directly on site: Our incentive is to support the success of our customers by providing tailor-made solutions. Our sales teams are close to our customers all over the world and are always available to provide advice and support for complex technical requirements.

In Germany, a comprehensive sales network of 3 commercial agencies and 12 field representatives ensures close-knit and competent customer support. Abroad, we are present in important countries such as France, Switzerland, England, the Netherlands, Poland, Finland, Russia, India and China with sales subsidiaries of our own. Furthermore, we cooperate in many countries with committed partners on an exclusive basis in a spirit of trust.

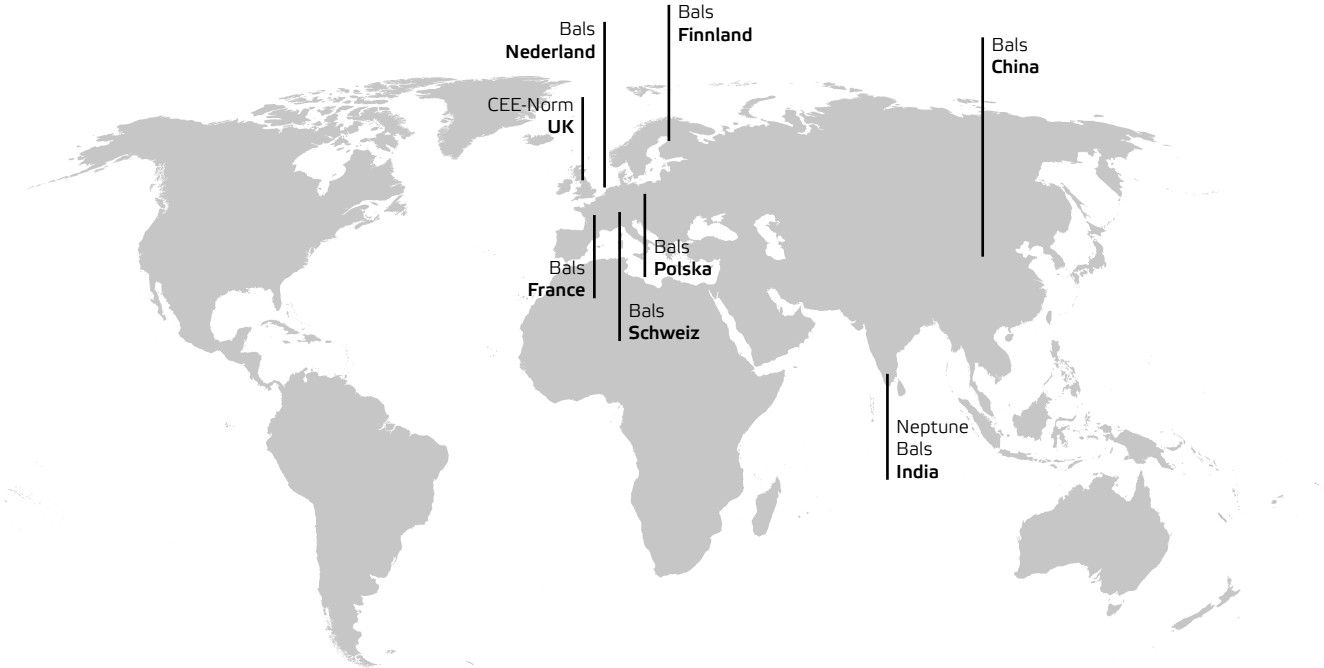

Bals subsidiaris worldwide



QUICK-CONNECT

- Invented in 1998 and patented by Bals: the screwless quick connection technology based on the spring-clamp principle
- Faster, more reliable and, above all, more controlled conductor connection
- The terminal accepts all types of copper conductors, rigid or flexible, with or without wire end ferrule as well as conductors of all quality grades irrespective of the conductor diameter or conductor insulation
- No wire end ferrules needed
- On delivery, the terminals are open and the contact pressure of the springs is optimally set
- Pressing the contact slide or locking lever with a finger visibly, audibly, reliably and permanently closes the terminal after the stripped conductor has been inserted
- Rewiring is no problem. Pressing the locking lever or contact slide again releases the conductor; unlike insulation displacement connector technology, the conductor can then be used again without needing further processing steps
- The damage-free conductor clamping guarantees an optimum connection over the entire service life
- QUICK-CONNECT is maintenance-free, insensitive to shocks, vibrations and temperature fluctuations

The following conductor cross sections can be used in the QUICK-CONNECT plugs and sockets:

QUICK-CONNECT plugs and connectors 16A:	1 mm ² - 2.5 mm ²	(flexible conductors)
QUICK-CONNECT panel and surface mounting socket outlets 16A:	1.5 mm ² - 4 mm ²	(rigid and multi-wire conductors)
QUICK-CONNECT plugs and connectors 32A:	2.5 mm ² - 10 mm ²	(flexible conductors)
QUICK-CONNECT panel and surface mounting socket outlets 32A:	2.5 mm ² - 10 mm ²	(rigid and multi-wire conductors)
QUICK-CONNECT plugs and connectors 63A:	6 mm ² - 16 mm ²	(flexible conductors)
QUICK-CONNECT panel and surface mounting socket outlets 63A:	6 mm ² - 25 mm ²	(rigid and multi-wire conductors)



QUICK-CONNECT is available in all CEE products up to 63A



QUICK-CONNECT connection technology in detail



MULTI-GRIP

- Cable gland system with integrated strain relief, invented by Bals in 2002
- The special cable gland is secured against self-loosening and unintentional loosening when inserting and withdrawing the plug by means of a buttress thread
- The rubber seal which is permanently joined to the enclosure cannot be lost. The time-consuming adjustment of the onion rings to the cable diameter is no longer necessary
- Simply tighten the MULTI-GRIP cable gland for damage-free, airtight and permanent mounting of the cable without any kind of deformation
- MULTI-GRIP cable glands achieve at least protection degree IP67
- Water no longer remains in the flared opening; it is instead forced out through the drainage openings
- The exterior strain relief system sits against the captive seal and prevents the penetration of water or dirt into the connection cavity of the plug even if the cable is moved
- The tensile strength exceeds the values specified in standards IEC 60309, EN 60309, VDE 0623 many times over
- The condition of the strain relief system can be inspected at any time from the outside without opening the plug enclosure

MULTI-GRIP easily adapts to almost all cable and wire types! The following cable diameters can be fed in without affecting the tightness or capacity for strain relief.

TE- and TE-Plus plugs and connectors	Cable diameter	TLS and QC standard plugs and connectors	Cable diameter
16A 3 and 4pole TE u. TE-Plus	Ø8 mm - Ø18 mm	TLS 16A 3 to 5pole	Ø8 mm - Ø18 mm
16A 5pole. TE and TE-Plus	Ø10 mm - Ø21 mm	TLS 32A 3 to 5pole	Ø11 mm - Ø23 mm
32A 3 and 4pole TE and TE-Plus	Ø11 mm - Ø23 mm	QC-Standard 16A 3 to 5pole	Ø8 mm - Ø18 mm
32A 5pole TE and TE-Plus	Ø13 mm - Ø27 mm	QC-Standard 32A 3 to 5pole	Ø11 mm - Ø23 mm
63A 3 to 5pole TE and TE-Plus	Ø16 mm - Ø36 mm	A reducer (type 29129) is available for all 16A plugs and sockets (see page 108). It allows cable diameters of less than Ø 8 mm to be sealed tightly.	
125A 3 to 5pole TE	Ø26 mm - Ø50 mm		



Permanently attached, captive seal



MULTI-GRIP cable gland achieves protection degree IP67



VARIABOX

- Fuse elements arranged below transparent, lockable operating window with user-friendly OTC mechanism (one touch close). It engages in the open state and locks again automatically when touched lightly
- Coded flange plate system for maximum safety during initial installation and maintenance
- All CEE sockets with screwless, maintenance-free QUICK-CONNECT technology and standardised flange dimensions, therefore independent of manufacturer if necessary
- Colours: bottom - black, top - electro-grey (enclosure top optionally available in the colours yellow, red, blue or silver)
- Surface mounting or mobile distributor versions in the sizes S (1-module), M (2-modules), L (3-modules), XL (4-modules), XXL (5-modules)
- Ready wired for installation
- Available in the protection degrees IP44, IP54 and IP67
- Enclosure made of high-grade, impact-resistant thermoplastic
- Top and bottom can be sealed together
- With external and internal fastening
- The cover screws are captive and can be actuated using a flat-tip or cross-tip screwdriver or using an internal or external hexagon spanner
- Modular expansion on all 4 sides
- Straight top hinged at side





EVOBOX

The EVOBOX series is the ideal solution for mobile power supply in industry, on construction sites or in event technology. The portable

Product information

- Available in 4 coordinated housing sizes
- Perfectly stackable
- Easy-to-handle, using integrated carrying grips
- No protruding components
- Fuse elements under transparent operating windows
- Distributor outlets and fuse elements each separately on one side
- Ready wired for installation
- The internal wiring is designed for the highest possible safety via the specification standard
- Resistant to ageing and weather
- Lightweight and impact resistant through the use of hard-polyethylene

Product details

- Impact strength IK10, up to 20J impact energy
- Self-extinguishing and UV-stabilized
- Highly resistant thermally and mechanically
- Maintenance-free QUICK-CONNECT-technology for CEE up to 63A and domestic sockets
- Overall protection degree of the distributor is IP54
- Flexible fitting options up to 125A

distributor series is available in 4 coordinated housing sizes and impresses with its high mechanical and thermal capacity.

Optional

- Adapted arrangement of panel mounting sockets for plugs with protection degree IP67
- Phase control lights are easily visible under operating windows
- External earthing screw outside the housing
- Installation of overvoltage protection
- The housing can be blue, red and orange (minimum order quantity)
- All panel mounting socket outlets are available in black

Power supply

- Cable entry with CEE plug up to max. 125A
- CEE inlet up to max. 125A



Also available in black



Perfectly stackable

Information

Our plugs and connectors

Domestic plug and connector

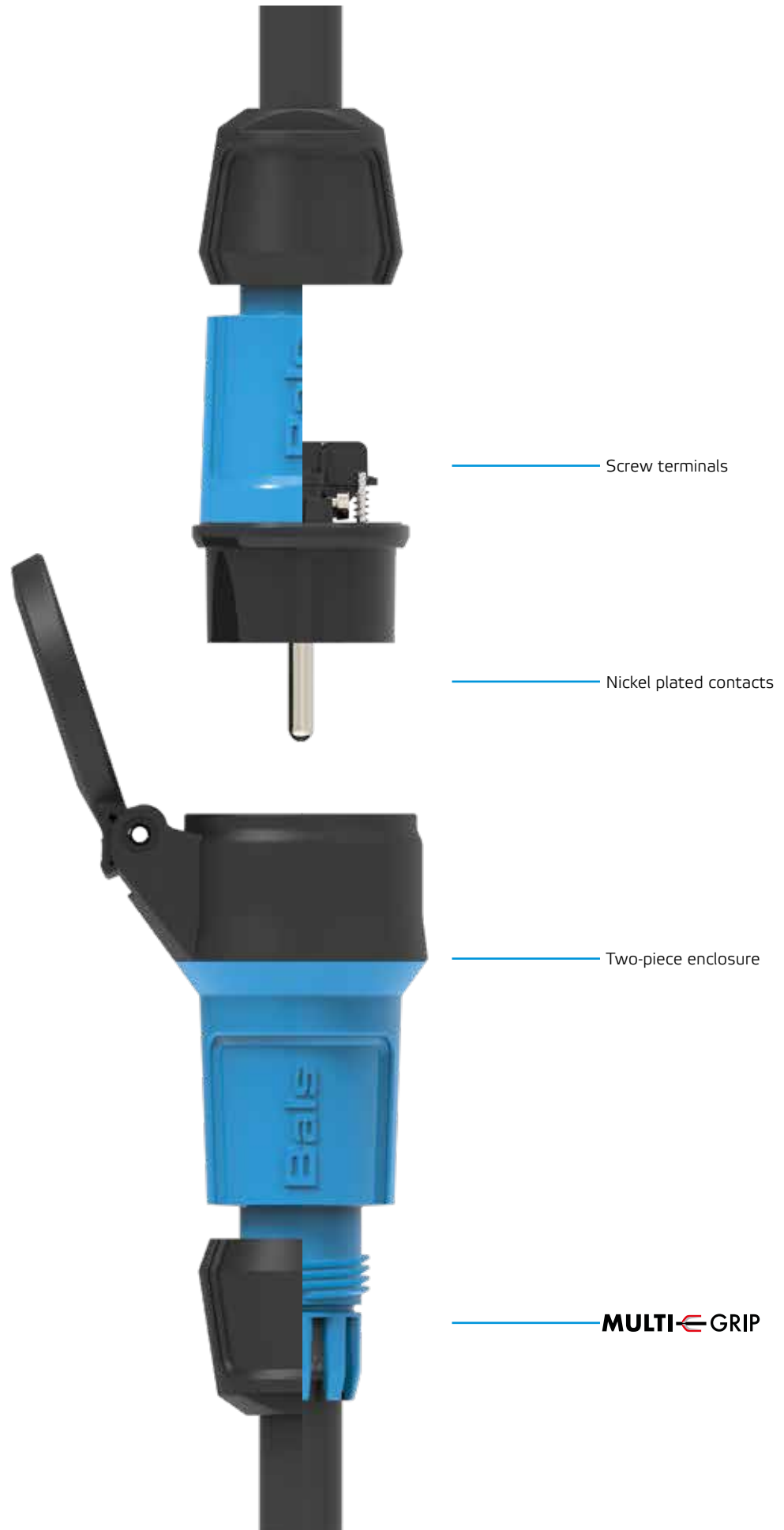

Plug and connector TLS 16A and 32A

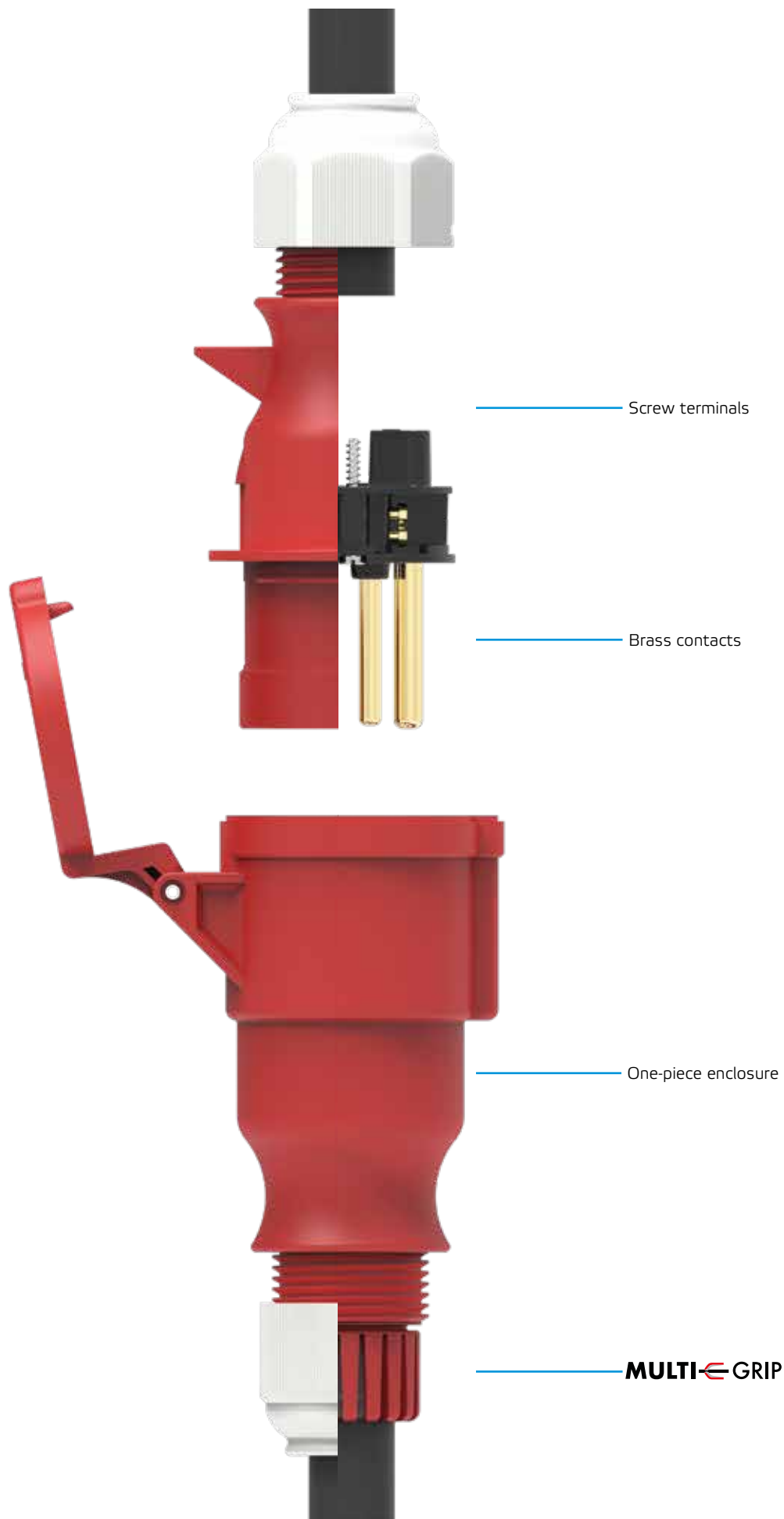

1

2

3

4

5

6

7

8

Information

Our plugs and connectors

Plug and connector QUICK-CONNECT 16A and 32A

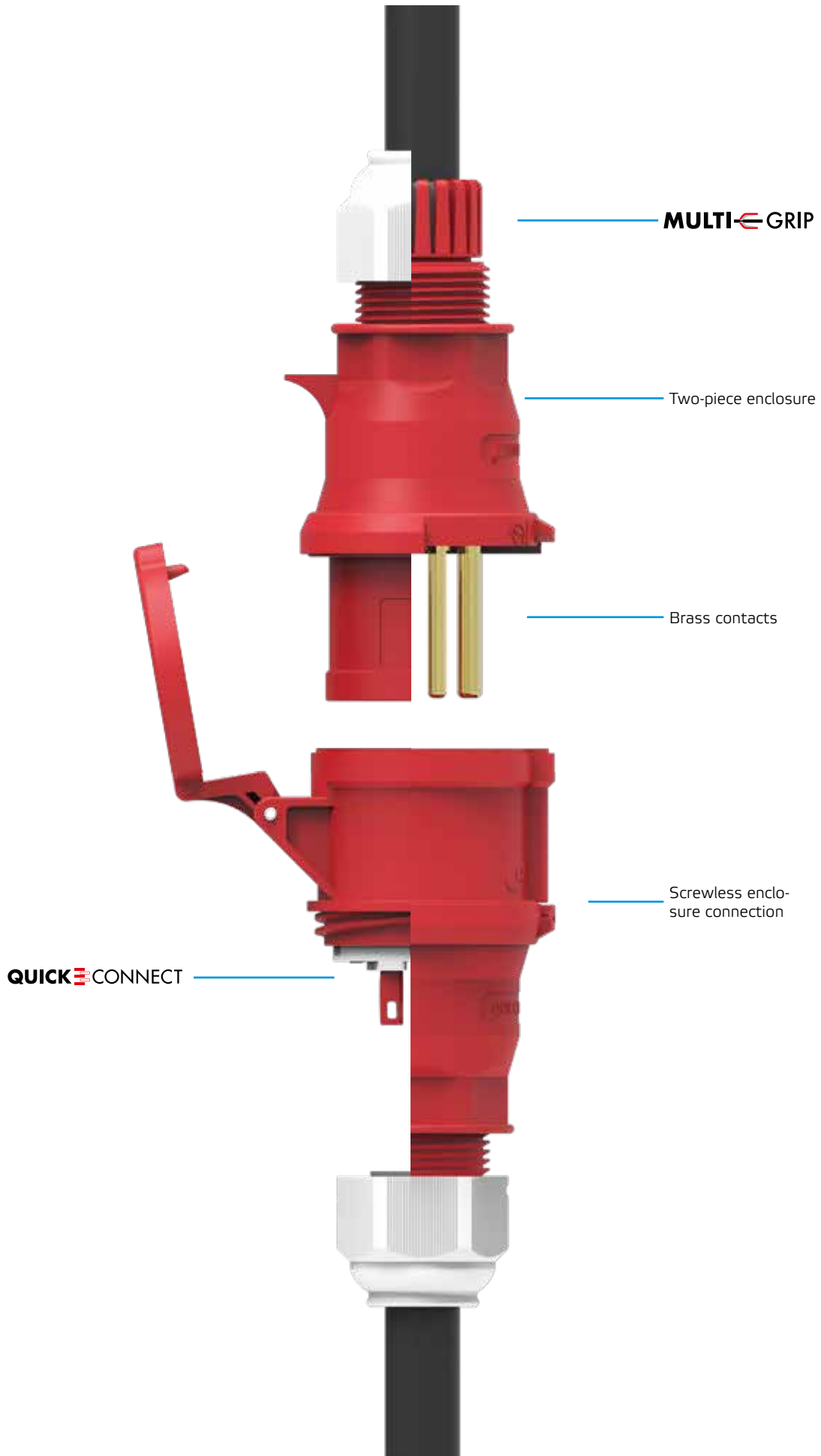

Plug and connector TE-Plus 16A and 32A

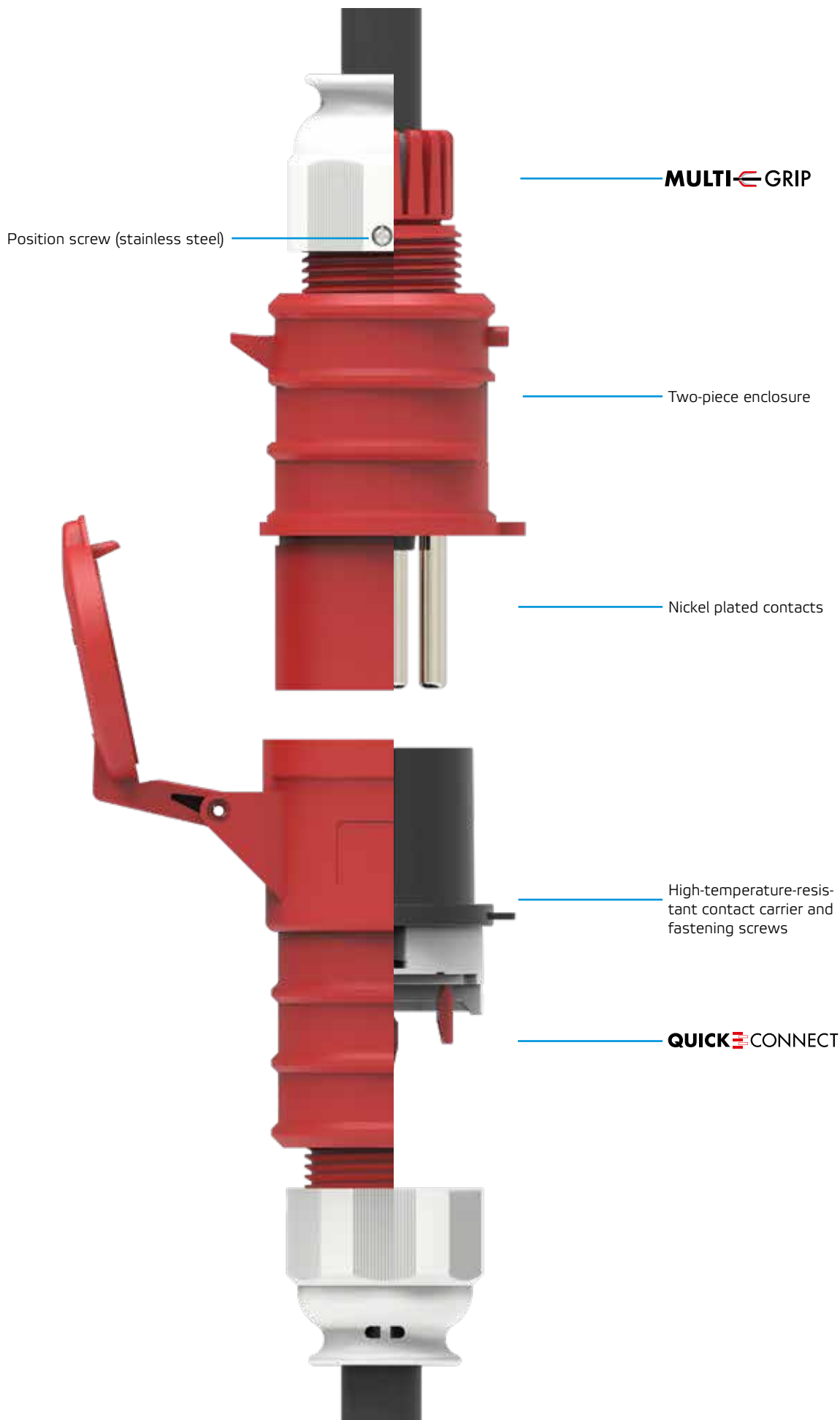

1

2

3

4

5

6

7

8

Installation requires electrical expertise

Electrotechnical products which previously could only be acquired from specialist shops and which were intended for qualified specialist personnel are today also offered to anybody in hardware stores and online stores as part of changed purchasing habits. This change brings with it new questions, however: is it permitted for specialised trade products requiring expertise for installation to be purchased and installed by anybody?

Many products are intended for installation in electrical systems or for the repair of devices, for example. Home renovations are often associated with replacing switches, sockets and subdistributors, or installing them from scratch. Faulty installations may have fatal consequences! As a rule, electrical installations and attachments should only be performed by an electrical specialist.



Product safety legislation

The German Product Safety Act [ProdSG] requires that only safe products may be brought into circulation – safe both in terms of installation and actual use.

Since it is not legally possible to define a group of purchasers for electrotechnical products, manufacturers should clearly and unambiguously stress that specialist knowledge is required for the installation. This is most successful using pictograms which everybody can understand. They help manufacturers to comply with the German Product Safety Act, thus reducing their product liability risks.

Warning symbol

„Installation, electrotechnical expertise“

In order to point out the hazard potential mentioned at the beginning, a visual notice is affixed to our packaging or directly onto our products which indicates that our products must exclusively be installed by electrical specialists.

This official product marking „Installation, electrotechnical expertise“ is standardised under IEC 60417- 6182 and is recommended by ZVEI, ZVEH and DKE.

Change to standard DIN EN 61439

As a successor standard to DIN EN 60439, standard DIN EN 61439 (2012) describes the requirements and documentation for all low-voltage switchgear assemblies. The standard is to be applied to power distributors, all switchgears and controlgears and meter cabinets. It therefore has a significant impact on electrical power distribution in industry, in building installation and on construction sites.

In future there will only be an overall view and the concept of the switchgear assembly. In place of a type test report, a design verification must be provided for new switchgears and power distributors. A low-voltage switchgear assembly is described through the definition of the interface parameters by the user or planner. Due to the interface parameters, the manufacturer must dimension and define the internal development of the low-voltage switchgear assembly.



The VARIABOX complies with DIN EN 61439

DIN EN 61439 (2012) is split between one part with general requirements and another part with a separate product standard for specific types of switchgear assemblies. The general basic requirements are laid out in DIN EN 61439-1 and adapted to the features of the application through relevant, additional sections of standards. As a result, we are able to apply the following three standards to our products:

1. Power switchgear assemblies in accordance with DIN EN 61439-2
2. Installation distributors in accordance with DIN EN 61439-3
3. Construction site power distributors in accordance with DIN EN 61439-4

Additional content of the standard is subdivided as follows: DIN EN 61439-5: Cable distribution cabinets, DIN EN 61439-6: Busbar distributors, DIN EN 61439-7: Switchgear assemblies for specific applications, spaces and installations of a special kind.

What does the standard mean for the end user?

DIN EN 61439 forms the basis for a clear definition of the performance promise that has been agreed between the user and manufacturer of a switchgear or controlgear system. Therefore, the fulfilling of the performance promise can be evaluated and represented for both parties. The effort involved in applying the new standard is not too dissimilar from the previous effort required. DIN EN 61439 leads the manufacturer to the required verifications in a structured manner. A manufacturer who applies the new standard correctly can definitively prove that its products can be operated safely and reliably.

Bals distributors: solutions tailored for DIN EN 61439

All plug-and-socket-device assemblies produced by Bals Elektrotechnik in accordance with the basic standard DIN EN 61439-1 and the corresponding standardisation sections DIN EN 61439-2, 61439-3 and 61439-4 can without exception be operated by non-experts. This includes the connection and disconnection of plug and socket devices as well as the operation of safety elements installed by us, such as miniature circuit breakers or residual current circuit breakers. The operating elements are installed in such a way that they comply with protection class IP 2X, which also covers protection class IP XXB (DIN EN 61439-3 Paragraph 8.2.2. and DIN EN 61439-2 Paragraph 8.101 Note 1). Non-experts are, of course, not permitted to open the housings of live assembly units. For this reason, it is only possible to open our housings using a suitable tool. Our distributors are usually pre-wired and ready for connection. For this reason, we are responsible for supplying verifications as the manufacturer of these products. We cannot declare any conformity for non-wired or partially wired devices requiring further modification, since the completion of the product is not performed by us on our premises.

I_n rated current of the assembly	IP degree of protection
 Typ IP44 Made in Germany	
Spannung voltage	200V/346V 240V/415V ~
Frequenz frequency	50 - 60Hz
I_n 40A	Maße dimension 390x230x145mm
RDF 0,8	Gewicht 5,898kg weight
$I_{cc} \leq 10kA$	Baujahr 10/17 year of construction
Temp -25/+40°C	
DIN EN 61439 - 3 CE	
I_{imp} rated voltage	U_{imp} 4kV
I_{cc} rated conditional short-circuit current	
RDF Rated load factor	

Type label example

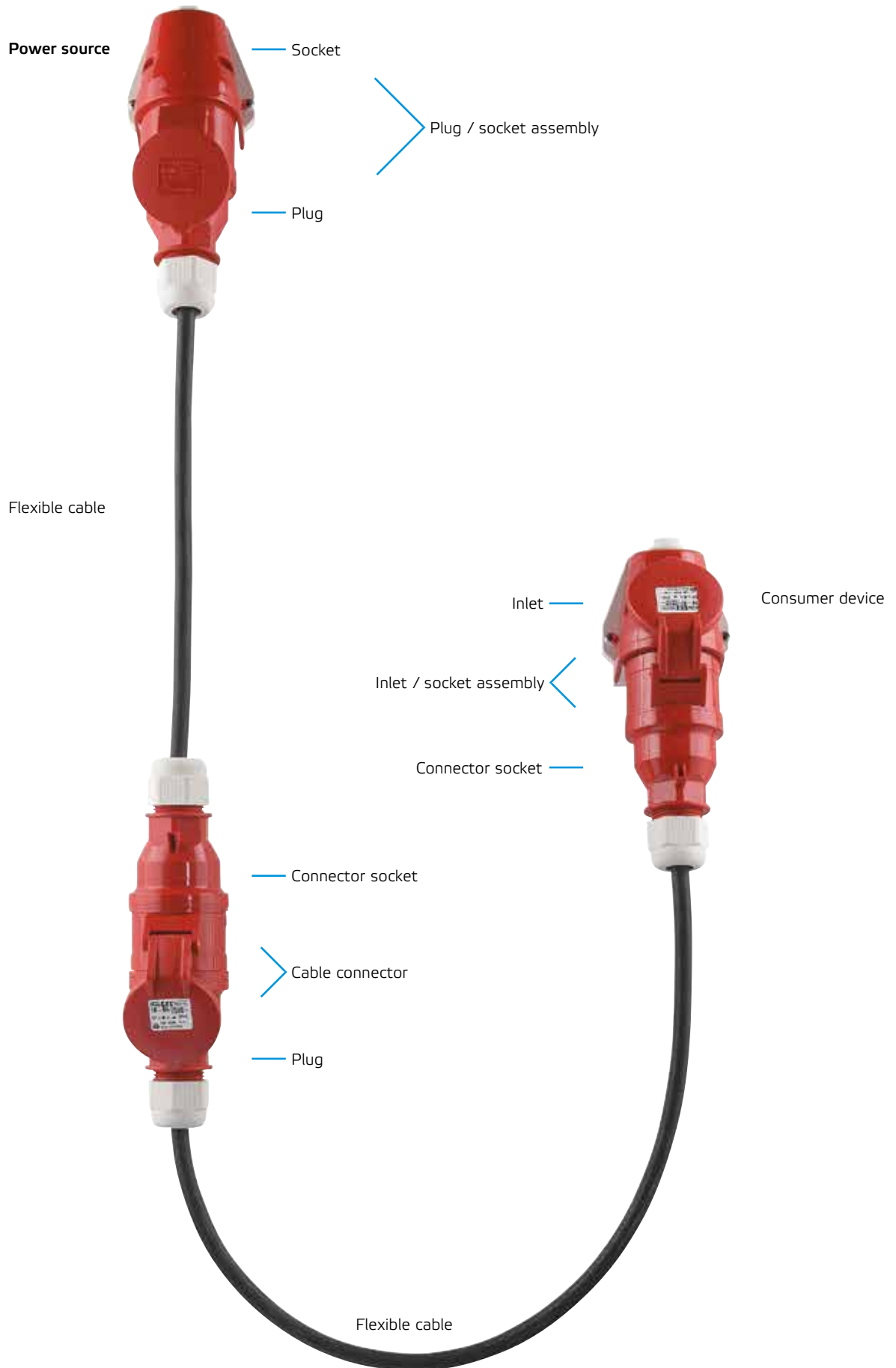

Information about CEE plugs and sockets for industrial applications

CEE plugs and sockets are internationally standardised by IEC 60309-1,-2 and also EN 60309-1,-2 valid in Europe.

IEC (International Electrotechnical Commission)

International electrotechnical commission responsible for worldwide standardisation in the electrotechnical field.

IECEE CB (IEC System for Conformity Testing to Standards for safety of Electrical Equipment)

IEC system for conformity testing of electrical equipment in accordance with safety standards.

CENELEC (European committee for electrotechnical standardisation)

International electrotechnical commission responsible for European standardisation in the electrotechnical field.

Series of EN 60309 standards

This European standard was ratified by CENELEC. The CENELEC members are obliged to comply with the requirements of the CEN/CENELEC rules of procedure which define the conditions under which this European standard is, without any modification, to be given the same status as a national standard.

This European standard shall exist in two official versions (English, French). A version in a different language that has been translated into the respective national language independently by the CENELEC member and communicated to the Central Secretariat shall have the same status as the official versions.

CEE standard system

To ensure that a plug cannot be inserted into a socket with a different voltage or frequency, the positions of the protective contacts relative to the keyway of the socket collar have been assigned to certain voltages and frequencies.

A groove in the connector collar and a corresponding lug on the plug prevent hazardous confusion between the systems. Even if this safety device is damaged, hazardous connection of the protective conductor pin and the phase sleeve is still not possible as the protective conductor pin which has a considerably larger diameter than the phase pin cannot be inserted into the phase sleeve.

Bals CEE plugs and sockets for amperages of 16A, 32A, 63A and 125A have sufficient switching capacity in accordance with DIN EN 60309 and can be actuated under load on consumables up to 690 V AC in accordance with DIN VDE 0100; corresponding test documents can be provided on request.

CEE plugs and sockets for amperages of 63A and 125A are equipped with a pilot contact that enables electrical interlocking or monitoring as per DIN EN 60309. This contact closes late when plugging in and opens early when pulling out.

System QUICK CONNECT

In 1998, Bals was the first manufacturer to introduce screwless connection technology based on the spring-clamp system onto the market under the brand name QUICK-CONNECT. Today, this technology developed by Bals is accepted and patented worldwide, is VDE-tested and has been approved without restriction.

The entire QUICK-CONNECT product range can therefore be used universally, consists of over 700 items and is available in all product categories and the customary protection degrees. Every year, Bals puts over 3 millions units of these unique products on the market worldwide and has consistently adapted its entire production and sales system to this innovation. The products are available from 16A 3p to 63A 5p as plugs, connectors and sockets.

QUICK-CONNECT puts an end to fault-prone threaded connections and prevents the inherent problems associated with insulation displacement connector technology. The time-saving and cost-cutting innovation from Bals is consistently marketed via the three-stage sales channel and, owing to its technical benefits and patented unique characteristics, offers major commercial opportunities for marketing agents and end users.

Bals focuses consistently on its inventions and therefore mentions a large part of the still available screw products only briefly at the end of this catalogue.

More information about the new technologies can be found on page 8 and 9, and on the introduction pages of the individual product groups.

Information

Position of protective contact and auxiliary lug

The illustration shows the position of the protective contact of a socket (front view) with rated operating voltages above 50 V, in accordance with DIN EN 60309-2. Plugs and inlets are mirror-inverted.

- 1) Mainly for ship installations
- 2) For reefer containers only (ISO standardised)
- 3) PE conductor required

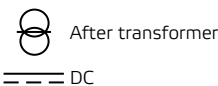
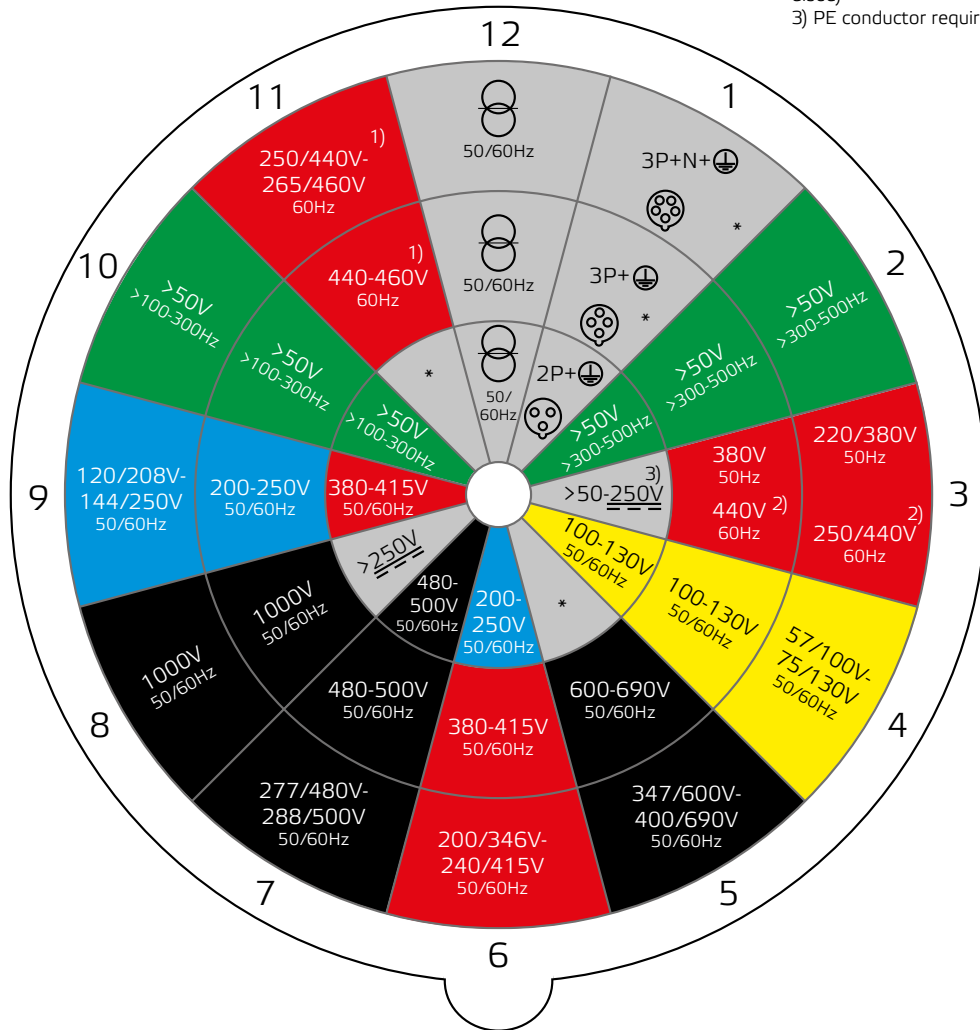







* All other configurations not covered by the rated operating voltages and / or frequencies. This clock face position can be additionally used in special applications when a distinction to standardized positions is required.

Position of the auxiliary lug relative to the basic lug for various voltages up to 50 V and frequencies up to 500 Hz in accordance with DIN EN 60309-2.

Poles	Frequency	Rated operating voltage	Position of auxiliary lug	Kennfarbe
2-, 3pol.	50 and 60	20 - 25	none	violet
	50 and 60	40 - 50	12 h	white
	100 - 200	40 - 50	4 h	green
	300	20 - 25 40 - 50	2 h	green
	400	20 - 25 40 - 50	3 h	green
	above 400 - 500	20 - 25 40 - 50	11 h	green

Colour Coding

When the operating voltage is indicated colour codes in addition to specified labels, the colour code given in the table below should be used:

Rated operating voltage or frequency	colour code
20 - 25 V	violet 
40 - 50 V	white 
100 - 130 V	yellow 
200 - 250 V	blue 
380 - 480 V	red 
500 - 690 V	black 
above 60-500 Hz	green 

Contact layout for CEE plugs and sockets

Greater than 50 V:

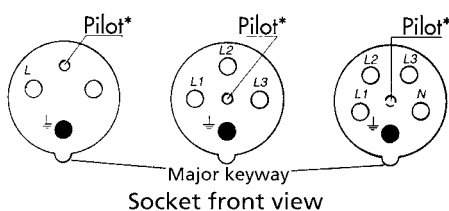

Up to 50 V:

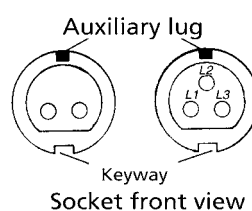

Identification of conductor connections















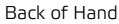



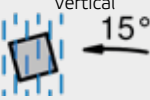



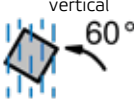







The connections must be labelled with the following symbols: L1, L2, L3 or 1, 2, 3 for the outer conductors.

The neutral conductor is labelled with N and the earth contact with .

*only at 63A and 125A

IP protection degrees for enclosures as per DIN EN 60529 (DIN VDE 0470)

IK-code as per DIN EN 62262 (VDE 0470)

1st code digit	Protection of the enclosure against penetration by	Protection against contact with	2nd code digit	Protection of the enclosure against harmful effects by	Code digit	Impact resistance
0	no protection 	no protection 	0	no protection 	0	not protected according to standard
1	Solid objects larger than 50mm 	Back of Hand 	1	Vertically falling dripping water 	01	Energy 0,140 Joule 
2	Solid objects larger than 12,5mm 	Finger 	2	Dripping water up to 15° relative to vertical 	02	Energy 0,200 Joule 
3	Solid objects larger than 2,5mm 	Tool 	3	Dripping water up to 60° relative to vertical 	05	Energy 0,700 Joule 
4	Solid objects larger than 1mm 	Wire 	4	Splashing water from all directions 	06	Energy 1 Joule 
5	Damaging dust deposits 	Wire 	5	Water jet from all directions 	07	Energy 2 Joule 
6	Dust-proof (full protection) 	Wire 	6	Strong water jets 	08	Energy 5 Joule 
			7	Immersion under specific pressure and time conditions 	09	Energy 10 Joule 
			8	Immersion under specific pressure for indefinite time* 	10	Energy 20 Joule 

Example IP67:

6 - Dust-proof (full protection)

7 - Immersion under specific pressure and time conditions

* Conditions are defined jointly by the manufacturer and end user. Tightening of the test conditions compared to code digit 7.

1

2

3

All Bals plugs and sockets are:

Impact-resistant, even at extremely low temperatures

Tested from -25°C up to +40°C

Dimensionally stable, even with high heat generation

Glow wire test at 650°C and 850°C

Protected against splashing water, watertight and dust-proof in accordance with protection degrees IP44 and IP67

Tests in accordance with DIN EN 60529, e.g. at water depth of 1 m

High switching capacity, can therefore also be connected and disconnected under load

Contacts and insert are subjected to a continuous mechanical, electrodynamic and thermal load

Ageing resistant

Long-term testing at a temperature of 80°C

Good electrical insulation properties

Plastic parts used insulate voltages of ≥ 2500 V~

Dimensionally stable and abrasion-resistant

Tested through years of use under harsh operating conditions

Environmentally friendly

Plugs and sockets are cadmium-free and halogen-free

4

5

6

The same generally applies for the plug/socket combination systems as for plugs and sockets, whereby here it is particularly important to take resistance against chemicals into consideration. The high-quality plastics and solid rubber used are suitable for the majority of applications. If, however, chemicals are used (e.g. for cleaning tasks in food processing plants), it may be necessary to use a different material (see "Material resistance list" on page 21) or contact us.



Glow wire test



Product testing at -25°C

7

8

Material resistance list

This list contains the most common chemicals. It provides information on the basic resistance of the listed materials in combination with the listed chemicals. The concentration of the chemicals and the ambient temperature must additionally

be taken into consideration. If other chemicals or a combination of chemicals are used, it is essential to perform a precise chemical resistance check.

■ resistant ■ conditionally resistant □ non-resistant

	Polyamide	Polycarbonate	Polyester	Rubber
Acetic acid 10%	□	■	■	□
Acetone	■	□	■	■
Alcohol (ethyl alcohol)	■	■	■	■
Alcoholic beverages	■	■	■	■
Ammonium (aqueous)	■	□	■	■
Benzene	■	□	■	□
Bromine	□	□	□	□
Butter	■	□	■	□
Caustic detergent solutions	■	■	■	■
Chlorine	■	■	■	■
Curd soap solution (2%)	■	■	■	■
Dichloromethane	■	□	□	□
Diesel oil, heating oil	■	■	■	■
Edible oils and edible fats	■	■	■	■
Ethyl ether	■	□	■	□
Fruit juices	■	■	■	■
Glycerine	■	■	■	■
Glycol	■	■	■	■
Hydrochloric acid (up to 35%)	□	■	□	■
Hydrofluorocarbons	■	□	■	□
Hydrogen peroxide (30%)	■	■	■	■
Iodine	□	■	□	■
Lard	■	□	■	■
Methanol	■	□	■	■
Milk	■	■	■	■
Mineral oils and mineral greases	■	■	■	■
Nitrobenzene	■	□	■	□
Ozone	□	■	□	■
Perchloroethylene	■	□	■	□
Petrol	■	■	■	□
Premium petrol (aromatic)	■	□	■	□
Soap solution (aqueous)	■	■	■	■
Sulphuric acid (up to 40%)	□	■	□	■
Toluene	■	□	■	□
Trichloroethylene	■	□	□	□
Urea	■	■	■	■
Washing-up liquid	■	■	■	■
Water (hot)	■	■	■	■
Water and seawater (cold)	■	■	■	■

Source: Werkstoff-Führer Kunststoff (Material Guide - Plastic)Hellerich/ Harsch/ Haenle 6th edition Bayer Kunststoff

Principal used materials and properties of Bals CEE plugs and sockets

	Connection technology	Material of contact carrier	Material of contact	Material of enclosure	Material of cover rivet	Material of fastening screw	Material of contact screw
TLS plug	Screw terminal	PA6	Brass	PA6	-	Steel blue galvanised	Steel nickel plated
Standard plug	QUICK CONNECT	PA6	Brass	PA6	-	-	-
TE plug	Screw terminal	PA6.6	Brass nickel-plated	PA6	-	Stainless Steel V2A	Steel nickel plated
TE-Plus plug	QUICK CONNECT	PA6.6	Brass nickel-plated	PA6	-	Stainless Steel V2A	-
TLS connector	Screw terminal	PA6	Brass	PA6	Brass	Steel blue galvanised	Steel nickel plated
Standard connector	QUICK CONNECT	PA6	Brass	PA6	Brass	-	-
TE connector	Screw terminal	PA6.6	Brass nickel-plated	PA6	Stainless Steel V2A	Stainless Steel V2A	Steel nickel plated
TE-Plus connector	QUICK CONNECT	PA6.6	Brass nickel-plated	PA6	Stainless Steel V2A	Stainless Steel V2A	-
Surface Mounting Socket Outlet Standard	QUICK CONNECT	1)	2)	3)	Brass	4)	-
TE Surface Mounting Socket Outlet	QUICK CONNECT	PA6.6	Brass nickel-plated	3)	Stainless Steel V2A	Stainless Steel V2A	-
Panel Mounting Socket Outlet Standard	QUICK CONNECT	1)	2)	PA6	Brass	-	-
TE Panel Mounting Socket Outlet	QUICK CONNECT	PA6.6	Brass nickel-plated	PA6	Stainless Steel V2A	-	-
Inlets	QUICK CONNECT	1)	2)	PA6	-	-	-
TE inlet	QUICK CONNECT	PA6.6	Brass nickel-plated	PA6	-	-	-

1) 16 + 32A made of PA6
63A made of PA6.6

2) 16 + 32A made of brass
63A made of brass (nickel-plated)

3) 16 + 32A made of PA6
63A made of PC

4) 16 + 32A made of steel (blue, galvanised)
63A made of stainless steel A2

PA6 (polyamide) and PC (polycarbonate) are high-grade plastics that are predominantly used for plugs, sockets and combinations
PA6.6 (polyamide with glass-fibre content) is a high-grade plastic that is characterised in particular by its high heat resistance.

Withdrawal forces for MULTI-GRIP cable gland system

Plug / connector	Cable ø	Torque		Pulling force as per EN 60309	Measured pulling force*
		min.	max.		
16A 3 and 4 pol.	8 mm	4 Nm	7 Nm	80 N	85 N (300 N)
16A 3 and 4 pol.	18 mm	4 Nm	7 Nm	80 N	200 N
16A 3 and 4 pol.	< 7 mm	4 Nm	7 Nm	with reducer type 29129	300 N
16A 5 pol. TLS and QC	8 mm	4 Nm	7 Nm	80 N	85 N
16A 5 pol. TLS and QC	18 mm	4 Nm	7 Nm	80 N	200 N
16A 5 pol. TE	10 mm	4 Nm	7 Nm	80 N	400 N
16A 5 pol. TE	21 mm	4 Nm	7 Nm	80 N	600 N
32A 3 and 4 pol.	11 mm	4,5 Nm	9 Nm	100 N	400 N
32A 3 and 4 pol.	23 mm	4,5 Nm	9 Nm	100 N	600 N
32A 5 pol. TLS and QC	11 mm	4,5 Nm	9 Nm	100 N	400 N
32A 5 pol. TLS and QC	23 mm	4,5 Nm	9 Nm	100 N	600 N
32A 5 pol. TE	13 mm	5 Nm	9,5 Nm	100 N	350 N
32A 5 pol. TE	27 mm	5 Nm	9,5 Nm	100 N	550 N
63A 3 - 5 pol.	24 mm	7,5 Nm	20 Nm	120 N	1900 N
63A 3 - 5 pol.	27 mm	7,5 Nm	20 Nm	120 N	2000 N
125A 3 - 5 pol.	36 mm	10 Nm	22 Nm	200 N	2700 N
125A 3 - 5 pol.	41 mm	10 Nm	22 Nm	200 N	2200 N

* Measured pulling force:
Room temperature 20°C, testing machine type TIRA tes 2710/1 Non-binding guideline values.
Rubber of cable: H07RN-F Reserve technical changes.





1

2

3

4









5

6





7

8



Surface Mounting Socket Outlets

<p>Surface Mounting Socket Outlets IP44</p>  <p>Pages 36 - 37</p>	<p>Surface Mounting Socket Outlets IP67</p>  <p>Pages 38 - 40</p>	<p>Surface Mounting Socket Outlets Straight IP44</p>  <p>Page 37</p>	<p>Surface Mounting Socket Outlets Straight IP67</p>  <p>Page 38</p>	<p>Surface Mounting Socket Outlets Combined</p>  <p>Page 41</p>
<p>Surface Mounting Socket Outlets Aggressive Cond.</p>  <p>Pages 42 - 43</p>	<p>Surface Mounting Socket Outlets with „PSC“</p>  <p>Page 44</p>	<p>Surface Mounting Socket Outlets Domestic</p>  <p>Page 45</p>		









Combined Surface Mounting Socket Outlets

<p>Fused</p>  <p>Pages 46 - 52</p>	<p>Switched, Interlocked</p>  <p>Pages 53 - 55</p>	<p>Switched, Fused</p>  <p>Pages 56 - 57</p>	<p>Switched, Interlocked, Fused</p>  <p>Pages 58 - 59</p>
--	--	--	---

Combined Surface Mounting Socket Outlets for harsh and / or aggressive Ambient Conditions

<p>Switched, Interlocked</p>  <p>Pages 60 - 61</p>	<p>Switched, Interlocked, Fused</p>  <p>Pages 62 - 63</p>
---	--

Panel Mounting Socket Outlets

<p>Straight, IP44</p>  <p>Pages 64 - 66</p>	<p>Angled, IP44</p>  <p>Pages 66 - 68</p>	<p>Straight, IP67</p>  <p>Pages 69 - 71</p>	<p>Angled, IP67</p>  <p>Pages 71 - 73</p>	<p>With Auxiliary Contact or PSC</p>  <p>Pages 74 - 75</p>
<p>Domestic Type</p>  <p>Page 75</p>	<p>For Harsh or Aggressive Conditions</p>  <p>Pages 76 - 77</p>	<p>Accessories for Sockets</p>  <p>Pages 78 - 79</p>		

Technical features

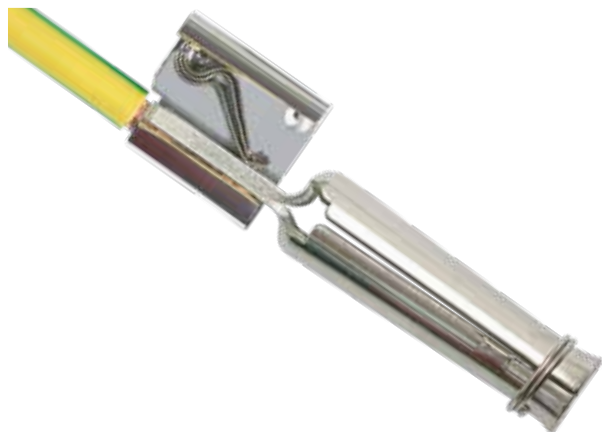
**Kontex-Contact**

- Defined contacting at the sleeve opening by means of the finely adjustable stainless-steel spring with excellent outstanding insertion and withdrawal forces
- High self-cleaning effect when the plug pin is inserted and removed reduces the risk of soiling and therefore failure of the plug and socket
- Terminal accept all types of conductor without problem

**Screwless QUICK-CONNECT terminals 16A and 32A**

- All QUICK-CONNECT sockets are touch-safe
- No wire end ferrules necessary
- Pressing the contact slide with your finger closes the terminal
- Reliable and permanent connection by means of spring-clamp technology
- The damage-free conductor clamping guarantees an optimum connection over the entire service life
- Rewiring without additional handling of the conductor

**Surface Mounting Socket Outlets QUICK-CONNECT**

- Cable entry from above
- Removable insert
- QUICK-CONNECT terminals
- External fastening

**HKS panel mounting sockets for elegant control, regulation, monitoring, checking**

- Additional auxiliary contact switch (HKS) is actuated by the plug
- Available on CEE angled Panel Mounting Socket Outlets 16A and 32A as well as on Domestic sockets
- Electrical plug interlocking possible
- Potential-free switching
- Switching element, e.g. contactor, can be set separately

Surface Mounting Socket Outlet QUICK-CONNECT

- Screwless terminals
- Kontex contact
- Cable entry 1x at top (open) and 1x at bottom (closed)
- Protection degree IP44

QUICK-CONNECT



112001

Ampere	Poles	110V 50-60 Hz			230V 50-60 Hz			400V 50-60 Hz			500V 50-60 Hz			>50V 100-300Hz			>50V 301-500Hz			Quantity	Each
		3pol	4pol	5pol	3pol	4pol	5pol	3pol	4pol	5pol	3pol	4pol	5pol	3pol	4pol	5pol	3pol	4pol	5pol		
16	3	11912			11895												10	170			
16	4				11910			11905			11914						10	200			
16	5							112001									10	220			
32	3	11918			11919												10	260			
32	4				11921			11922			11924						10	275			
32	5				11926			112002			11927						10	300			

Ampere	Poles	a	b	c	d	e	f	h	i	k	ø l	m	n	Cond. mm² min	Cond. mm² max
16	3	59,5	90,0	130,0	85,0	62,0	33,5	9,0	5,5	8,0	21,0	72,0	M20	1,5	4
16	4	72,4	90,0	130,0	96,0	77,0	33,5	9,0	5,5	9,0	21,0	87,0	M25	1,5	4
16	5	72,4	90,0	131,0	98,0	77,0	33,5	9,0	5,5	9,0	21,0	87,0	M25	1,5	4
32	3	79,1	92,0	142,0	103,0	84,0	30,0	9,0	5,5	9,0	21,0	94,0	M25	2,5	10
32	4	79,1	92,0	142,0	103,0	84,0	30,0	9,0	5,5	9,0	21,0	94,0	M25	2,5	10
32	5	79,1	92,0	142,0	106,0	84,0	30,0	9,0	5,5	9,0	21,0	94,0	M25	2,5	10

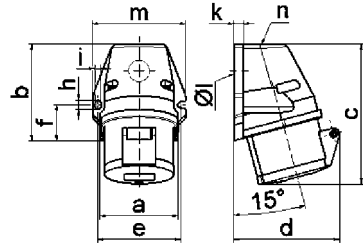

1 MB 19

Surface Mounting Socket Outlet QUICK-CONNECT

- Screwless terminals
- Kontex contact
- Cable entry 1x at top (open), 1x at bottom and 1x at rear (closed)
- Base rotatable by 180°
- Protection degree IP44

QUICK-CONNECT



11906

Ampere	Poles	110V 50-60 Hz			230V 50-60 Hz			400V 50-60 Hz			500V 50-60 Hz			>50V 100-300Hz			>50V 301-500Hz			Quantity	Each
		3pol	4pol	5pol	3pol	4pol	5pol	3pol	4pol	5pol	3pol	4pol	5pol	3pol	4pol	5pol	3pol	4pol	5pol		
16	3	11928			11930			11931			11932			11933			11934			10	185
16	4							11907												10	240
16	5							11906												10	260

Ampere	Poles	a	b	c	d	e	f	h	ø h	i	k	l	m	Cond. mm² min	Cond. mm² max
16	3	64,0	87,0	117,0	103,0	51,0	-	4,1	4,5	40,0	M20	für M20	1,5	4	
16	4	75,0	100,0	129,0	108,0	59,0	11,0	5,1	4,5	-	M20	für M20	1,5	4	
16	5	75,0	100,0	131,0	116,0	59,0	11,0	5,1	4,5	-	M20	für M20	1,5	4	

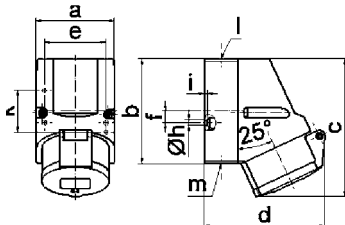

1 MB 7

Surface Mounting Socket Outlet QUICK-CONNECT

- Screwless terminals
- Kontex contact
- Cable entry 1x at top (open), 2x at bottom (closed)
- Base rotatable by 180°
- Suitable for feed-through wiring with special terminals
- Protection degree IP44

QUICK-CONNECT

Twin terminal



11909

Ampere	Poles	110V 50-60 Hz			230V 50-60 Hz			400V 50-60 Hz			500V 50-60 Hz			>50V 100-300Hz			>50V 301-500Hz			Quantity	Each
		3pol	4pol	5pol	3pol	4pol	5pol	3pol	4pol	5pol	3pol	4pol	5pol	3pol	4pol	5pol	3pol	4pol	5pol		
16	4							11944			11945						10	305			
16	5							11909			11947						10	325			
32	3	11948			11949												10	350			
32	4				11955			11956			11957			110073			10	365			
32	5	11960			110322			11962			11963						10	405			
16	5							110451									10	330			

Ampere	Poles	a	b	c	d	e	f	h	ø h	i	ø k	l	m	ø n	o	p	Cond. mm² min	Cond. mm² max
16	4	83,0	126,0	153,0	127,0	68,0	11,0	5,5	6,5	12,0	65,0	80,0	10,0	M25	2xM25	1,5	4	
16	5	83,0	126,0	155,0	130,0	68,0	11,0	5,5	6,5	12,0	65,0	80,0	10,0	M25	2xM25	1,5	4	
32	3	83,0	126,0	155,0	130,0	68,0	11,0	5,5	6,5	12,0	65,0	80,0	10,0	M25	2xM25	2,5	10	
32	4	83,0	126,0	155,0	130,0	68,0	11,0	5,5	6,5	12,0	65,0	80,0	10,0	M25	2xM25	2,5	10	
32	5	83,0	126,0	155,0	136,0	68,0	11,0	5,5	6,5	12,0	65,0	80,0	10,0	M25	2xM25	2,5	10	

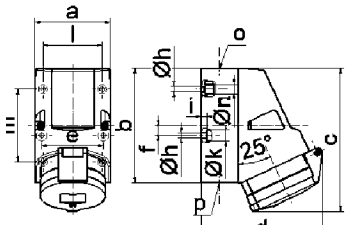

1 MB 2

Surface Mounting Socket Outlet QUICK-CONNECT, straight

- Screwless terminals
- Kontex contact
- Cable entry 7x M20/25
- With large wiring space
- Protection degree IP44

QUICK-CONNECT



110558

Ampere	Poles	110V 50-60 Hz	230V 50-60 Hz	400V 50-60 Hz	500V 50-60 Hz	>50V 100-300Hz	>50V 301-500Hz	Quantity	Each
		3pol 4pol 5pol 4h 4h 4h	3pol 4pol 5pol 6h 9h 9h	3pol 4pol 5pol 9h 6h 6h	3pol 4pol 5pol 7h 7h 7h	3pol 4pol 5pol 10h 10h 10h	3pol 4pol 5pol 2h 2h 2h		
16	3	110542	110541	110543				10	320
16	4	110545	110544	110546				10	335
16	5	110548	110547	110549				10	355
32	3	110551	110550	110552				10	380
32	4	110554	110553	110555				10	395
32	5	110557	110556	110558				10	435

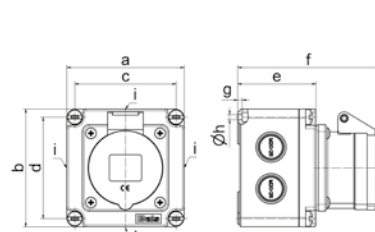

1 MB 120

Ampere	16	16	16	32	32	32
Poles	3	4	5	3	4	5
a	102,0	102,0	102,0	102,0	102,0	102,0
b	102,0	102,0	102,0	102,0	102,0	102,0
c	88,0	88,0	88,0	88,0	88,0	88,0
d	88,0	88,0	88,0	88,0	88,0	88,0
e	68,0	68,0	68,0	68,0	68,0	68,0
f	119,0	121,0	122,0	130,0	130,0	131,0
g	4,0	4,0	4,0	4,0	4,0	4,0
h	4,5	4,5	4,5	4,5	4,5	4,5
i	2xM20/25	2xM20/25	2xM20/25	2xM20/25	2xM20/25	2xM20/25
k	M20/25	M20/25	M20/25	M20/25	M20/25	M20/25
Cond. mm² min	1,5	1,5	1,5	2,5	2,5	2,5
Cond. mm² max	4	4	4	10	10	10

Surface Mounting Socket Outlet

- Cable entry 1x at top (open), 2x at bottom (closed)
- Base rotatable by 180°
- Nickel plated contacts
- Kontex contact
- Box terminals
- Protection degree IP44
- For screw terminal Surface Mounting Socket Outlets with PILOT, please add -P to the ref. no.



1124

Ampere	Poles	110V 50-60 Hz	230V 50-60 Hz	400V 50-60 Hz	500V 50-60 Hz	>50V 100-300Hz	>50V 301-500Hz	Quantity	Each
		3pol 4pol 5pol 4h 4h 4h	3pol 4pol 5pol 6h 9h 9h	3pol 4pol 5pol 9h 6h 6h	3pol 4pol 5pol 7h 7h 7h	3pol 4pol 5pol 10h 10h 10h	3pol 4pol 5pol 2h 2h 2h		
63	4			110415	110445			5	900
63	5			110383				5	945
Screw terminal:									
63	3	1106	1104	1107	11795	11345	11640	5	780
63	4	1125	1126	1127	1128	11221	11051	5	795
63	5	1129	1130	1124	11208	11429	1108	5	830

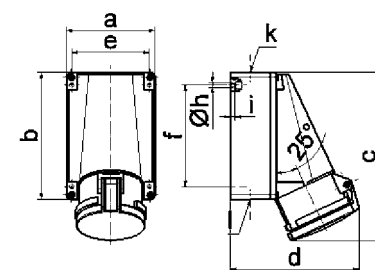

1 MB 4

Ampere	16	16	16
Poles	3	4	5
a	118,0	118,0	118,0
b	170,0	170,0	170,0
c	223,0	223,0	223,0
d	168,0	168,0	168,0
e	104,0	104,0	104,0
f	136,0	136,0	136,0
ø h	6,1	6,1	6,1
i	6,0	6,0	6,0
k	M40	M40	M40
l	M32/32	M32/32	M32/32
Cond. mm² min	6	6	6
Cond. mm² max	25	25	25

Surface Mounting Socket Outlet QUICK-CONNECT TE

- Screwless terminals
- Kontex contact
- High-temperature-resistant contact carrier
- Nickel plated contacts
- Box terminals
- With large wiring space
- Protection degree IP44

QUICK-CONNECT



110487

Ampere	Poles	110V 50-60 Hz	230V 50-60 Hz	400V 50-60 Hz	500V 50-60 Hz	>50V 100-300Hz	>50V 301-500Hz	Quantity	Each
		3pol 4pol 5pol 4h 4h 4h	3pol 4pol 5pol 6h 9h 9h	3pol 4pol 5pol 9h 6h 6h	3pol 4pol 5pol 7h 7h 7h	3pol 4pol 5pol 10h 10h 10h	3pol 4pol 5pol 2h 2h 2h		
63	4			110486				1	1580
63	5			110487				1	1690

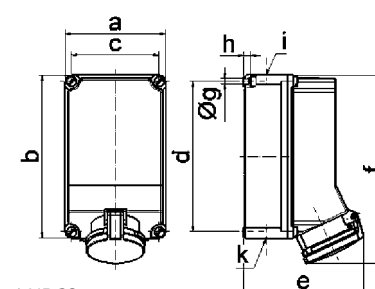

1 MB 28

Ampere	63	63
Poles	4	5
a	160,0	160,0
b	260,0	260,0
c	140,0	140,0
d	240,0	240,0
e	184,0	184,0
f	302,0	302,0
ø g	8,1	8,1
h	10,0	10,0
i	M40	M40
k	M32/40	M32/40
Cond. mm² min	6	6
Cond. mm² max	25	25

Surface Mounting Socket Outlet QUICK-CONNECT, straight

- Screwless terminals
- Kontex contact
- Cable entry 7x M20/25
- With large wiring space
- Protection degree IP67

QUICK-CONNECT



110576

Ampere	Poles	110V	230V	400V	500V	>50V	>50V	Quantity	Each
		50-60 Hz	50-60 Hz	50-60 Hz	50-60 Hz	100-300Hz	301-500Hz		
		3pol 4pol 5pol	3pol 4pol 5pol	3pol 4pol 5pol	3pol 4pol 5pol	3pol 4pol 5pol	3pol 4pol 5pol		
		4h 4h 4h	6h 9h 9h	9h 6h 6h	7h 7h 7h	10h 10h 10h	2h 2h 2h		
16	3	110560	110559	110561				10	340
16	4	110563	110564	110562				10	355
16	5	110566	110567	110565				10	375
32	3	110569	110568	110570				10	415
32	4	110572	110571	110573				10	435
32	5	110575	110574	110576				10	470

Ampere	Poles	16	16	16	32	32	32
a	102,0	102,0	102,0	102,0	102,0	102,0	102,0
b	102,0	102,0	102,0	102,0	102,0	102,0	102,0
c	88,0	88,0	88,0	88,0	88,0	88,0	88,0
d	88,0	88,0	88,0	88,0	88,0	88,0	88,0
e	68,0	68,0	68,0	68,0	68,0	68,0	68,0
f	124,0	125,0	124,0	134,0	134,0	134,0	134,0
g	4,0	4,0	4,0	4,0	4,0	4,0	4,0
ø h	4,5	4,5	4,5	4,5	4,5	4,5	4,5
i	2xM20/25	2xM20/25	2xM20/25	2xM20/25	2xM20/25	2xM20/25	2xM20/25
k	M20/25	M20/25	M20/25	M20/25	M20/25	M20/25	M20/25
Cond. mm² min	1,5	1,5	1,5	2,5	2,5	2,5	2,5
Cond. mm² max	4	4	4	10	10	10	10

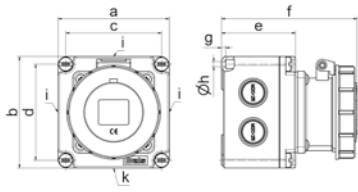

1 MB 121

Surface Mounting Socket Outlet

- Screw terminals
- Cable entry 1x at top (open), with 16A 1x and with 32A 2x at bottom (closed)
- Base rotatable by 180°
- Protection degree IP67



1155

Ampere	Poles	110V	230V	400V	500V	>50V	>50V	Quantity	Each
		50-60 Hz	50-60 Hz	50-60 Hz	50-60 Hz	100-300Hz	301-500Hz		
		3pol 4pol 5pol	3pol 4pol 5pol	3pol 4pol 5pol	3pol 4pol 5pol	3pol 4pol 5pol	3pol 4pol 5pol		
		4h 4h 4h	6h 9h 9h	9h 6h 6h	7h 7h 7h	10h 10h 10h	2h 2h 2h		
16	3	1132	1133	1134	11320	11350	11027	10	210
16	4	1135	1136	1137	1138	1139	1140	10	265
16	5	1141	1142	1143	11343	11390	11342	10	300
32	3	1144	1145	1146				10	395
32	4	1147	1148	1149	1150	1151	1152	10	415
32	5	1153	1154	1155	11326	11432	11025	10	450

Ampere	Poles	16	16	16	32	32	32
a	64,0	75,0	75,0	83,0	83,0	83,0	83,0
b	87,0	100,0	100,0	126,0	126,0	126,0	126,0
c	115,0	130,0	130,0	160,0	160,0	160,0	160,0
d	103,0	110,0	115,0	129,0	129,0	135,0	135,0
e	51,0	59,0	59,0	68,0	68,0	68,0	68,0
f	20,0	11,0	11,0	11,0	11,0	11,0	11,0
g	20,0	-	-	-	-	-	-
ø h	4,1	5,1	5,1	5,5	5,5	5,5	5,5
i	4,5	4,5	4,5	6,5	6,5	6,5	6,5
ø k	8,0	10,0	10,0	12,0	12,0	12,0	12,0
l	-	-	-	65,0	65,0	65,0	65,0
m	-	-	-	80,0	80,0	80,0	80,0
ø n	-	-	-	10,0	10,0	10,0	10,0
o	M20	M20	M20	M25	M25	M25	M25
p	f. M20	f. M20	f. M20	2xM25	2xM25	2xM25	2xM25
Cond. mm² min	1,5	1,5	1,5	2,5	2,5	2,5	2,5
Cond. mm² max	4	4	4	10	10	10	10

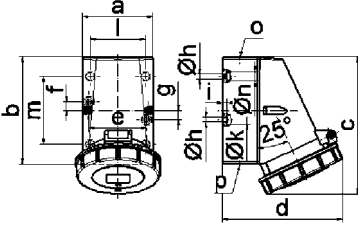

1 MB 13

Surface Mounting Socket Outlet QUICK-CONNECT TE

- Screwless terminals
- Kontex contact
- High-temperature-resistant contact carrier
- Nickel plated contacts
- With large wiring space
- Protection degree IP67

QUICK-CONNECT



110094

Ampere	Poles	110V	230V	400V	500V	>50V	>50V	Quantity	Each
		50-60 Hz	50-60 Hz	50-60 Hz	50-60 Hz	100-300Hz	301-500Hz		
		3pol 4pol 5pol	3pol 4pol 5pol	3pol 4pol 5pol	3pol 4pol 5pol	3pol 4pol 5pol	3pol 4pol 5pol		
		4h 4h 4h	6h 9h 9h	9h 6h 6h	7h 7h 7h	10h 10h 10h	2h 2h 2h		
16	3	11579	11492			110436		1	430
16	4		11630	11493	11155			1	450
16	5	11566		110094		110435		1	480

Ampere	Poles	16	16	16
a	90,0	90,0	90,0	90,0
b	170,0	170,0	170,0	170,0
c	77,0	77,0	77,0	77,0
d	137,5	137,5	137,5	137,5
e	108,0	115,0	122,0	122,0
f	191,5	191,5	195,0	195,0
g	6,5	6,5	6,5	6,5
ø h	5,5	5,5	5,5	5,5
i	M20	M20	M20	M20
k	M20/25	M20/25	M20/25	M20/25
Cond. mm² min	1,5	1,5	1,5	1,5
Cond. mm² max	4	4	4	4

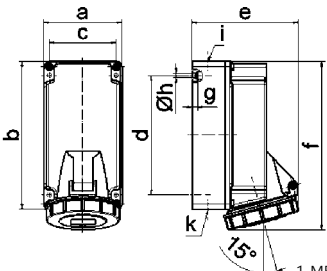

1 MB 8

Surface Mounting Socket Outlet QUICK-CONNECT TE

- Screwless terminals
- Kontex contact
- High-temperature-resistant contact carrier
- Nickel plated contacts
- With large wiring space
- Protection degree IP67

QUICK-CONNECT



110075

Ampere	Poles	110V	230V	400V	500V	>50V	>50V	Quantity	Each
		50-60 Hz	50-60 Hz	50-60 Hz	50-60 Hz	100-300Hz	301-500Hz		
32	3	11580	11496	11879				1	825
32	4		11555	11461	11156			1	830
32	5			110075				1	850

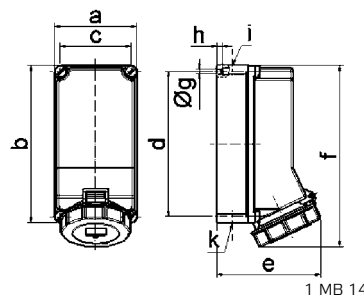

Ampere	32	32	32
Poles	3	4	5
a	118,0	118,0	118,0
b	225,0	225,0	225,0
c	101,0	101,0	101,0
d	208,0	208,0	208,0
e	143,0	143,0	149,0
f	255,0	255,0	255,0
ø g	6,5	6,5	6,5
h	8,0	8,0	8,0
i	2xM25	2xM25	2xM25
k	2xM25	2xM25	2xM25
Cond. mm² min	2,5	2,5	2,5
Cond. mm² max	10	10	10

Surface Mounting Socket Outlet

- Cable entry 1x at top (open), 1x at bottom (closed)
- Nickel plated contacts
- Base rotatable by 180°
- Kontex contact
- Box terminals
- Protection degree IP67
- For screw terminal Surface Mounting Socket Outlets with PILOT, please add -P to the ref. no.



1112

Ampere	Poles	110V	230V	400V	500V	>50V	>50V	Quantity	Each
		50-60 Hz	50-60 Hz	50-60 Hz	50-60 Hz	100-300Hz	301-500Hz		
63	4			110416	110446			5	960
63	5			110413				5	1005

Screw terminal:

Ampere	Poles	110V	230V	400V	500V	>50V	>50V	Quantity	Each
		50-60 Hz	50-60 Hz	50-60 Hz	50-60 Hz	100-300Hz	301-500Hz		
63	3	1156	1157	1158		11748		5	800
63	4	1159	1160	1161	1162	11433	11341	5	840
63	5	1163	1164	1112	11017	11368	11126	5	875

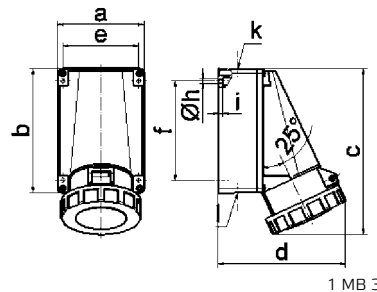

Ampere	63	63	63
Poles	3	4	5
a	118,0	118,0	118,0
b	170,0	170,0	170,0
c	228,0	228,0	228,0
d	176,0	176,0	176,0
e	104,0	104,0	104,0
f	136,0	136,0	136,0
ø h	6,1	6,1	6,1
i	6,0	6,0	6,0
k	M40	M40	M40
l	M32/32	M32/32	M32/32
Cond. mm² min	6	6	6
Cond. mm² max	25	25	25

Surface Mounting Socket Outlet

- Screw terminals
- Cable entry 1x M50 at top
- High-temperature-resistant contact carrier
- Kontex contact
- Nickel plated contacts
- Box terminals
- Protection degree IP67
- For Surface Mounting Socket Outlets with PILOT, please add -P to the ref. no.



11447

Ampere	Poles	110V	230V	400V	500V	>50V	>50V	Quantity	Each
		50-60 Hz	50-60 Hz	50-60 Hz	50-60 Hz	100-300Hz	301-500Hz		
125	3	11436	11437	11438	110452			1	1535
125	4	11439	11440	11441	11442	11443	11444	1	1965
125	5	11445	11446	11447			110468	1	2085

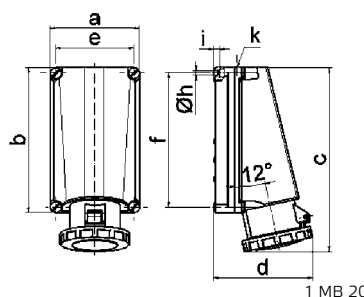

Ampere	125	125	125
Poles	3	4	5
a	160,0	160,0	160,0
b	260,0	260,0	260,0
c	330,0	330,0	330,0
d	168,0	168,0	168,0
e	140,0	140,0	140,0
f	240,0	240,0	240,0
ø h	8,3	8,3	8,3
i	10,0	10,0	10,0
k	M50	M50	M50
Cond. mm² min	25	25	25
Cond. mm² max	70	70	70

Surface Mounting Socket Outlet QUICK-CONNECT

- Screwless terminals
- Kontex contact
- High-temperature-resistant contact carrier
- Nickel plated contacts
- Box terminals
- With large wiring space
- Protection degree IP67

QUICK-CONNECT



110489

3P+E		3P+E		3+N+E		110V 50-60 Hz			230V 50-60 Hz			400V 50-60 Hz			500V 50-60 Hz			>50V 100-300Hz			>50V 301-500Hz			Quantity	g
Ampere	Poles	3pol	4pol	5pol	3pol	4pol	5pol	3pol	4pol	5pol	3pol	4pol	5pol	3pol	4pol	5pol	3pol	4pol	5pol	3pol	4pol	5pol			
63	4																						1	1620	
63	5																						1	1730	

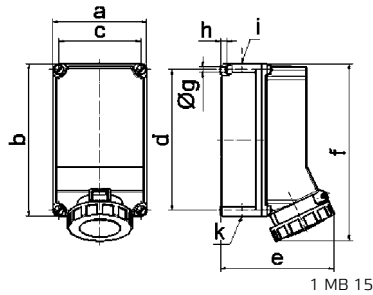

Ampere	63	63
Poles	4	5
a	160,0	160,0
b	260,0	260,0
c	140,0	140,0
d	240,0	240,0
e	195,0	195,0
f	304,0	304,0
ø g	8,1	8,1
h	10,0	10,0
i	M40	M40
k	M32/40	M32/40
Cond. mm² min	6	6
Cond. mm² max	25	25

1 MB 15

Surface Mounting Socket Outlet

- Screw terminals
- Kontex contact
- High-temperature-resistant contact carrier
- Nickel plated contacts
- Box terminals
- With large wiring space
- Protection degree IP67
- For Surface Mounting Socket Outlets with PILOT, please add -P to the ref. no.



11479

3P+E		3P+E		3+N+E		110V 50-60 Hz			230V 50-60 Hz			400V 50-60 Hz			500V 50-60 Hz			>50V 100-300Hz			>50V 301-500Hz			Quantity	g
Ampere	Poles	3pol	4pol	5pol	3pol	4pol	5pol	3pol	4pol	5pol	3pol	4pol	5pol	3pol	4pol	5pol	3pol	4pol	5pol	3pol	4pol	5pol			
125	3																						1	2850	
125	4																						1	2900	
125	5																						1	3195	

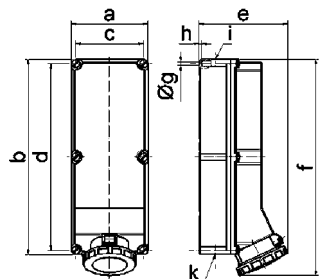

Ampere	125	125	125
Poles	3	4	5
a	180,0	180,0	180,0
b	460,0	460,0	460,0
c	160,0	160,0	160,0
d	440,0	440,0	440,0
e	208,0	208,0	208,0
f	510,0	510,0	510,0
ø g	8,3	8,3	8,3
h	6,5	6,5	6,5
i	M40	M40	M40
k	M40/50	M40/50	M40/50
Cond. mm² min	25	25	25
Cond. mm² max	70	70	70

1 MB 10

TK-Combi Socket QUICK-CONNECT

- Screwless terminals
- With terminals, with wiring (ready wired for installation)
- 109-QC with fuse base 5 x 20 mm
- With integrated domestic socket 16A/230V ~ (type F - German standard)
- Protection degree IP44

Accessories: see page 79

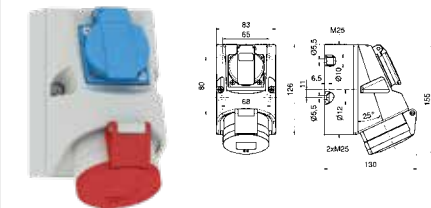
QUICK-CONNECT

1010-QC

1 MB 122

Amperes	Poles	230V 50-60 Hz			400V 50-60 Hz			Quantity	Each
		3pol 6h	4pol 9h	5pol 9h	3pol 9h	4pol 6h	5pol 6h		
16	5				109-QC			10	
16	5				1010-QC			10	

TK-Combi Socket

- With terminals, without wiring
- With integrated domestic socket 16A/230V ~ (type F - German standard)
- Protection degree IP44

¹⁾ In the case of wiring using only one supply cable, use fuse base type 1862

Accessories: see page 79

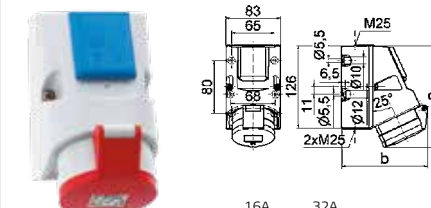

108

1 MB 17

Amperes	Poles	230V 50-60 Hz			400V 50-60 Hz			Quantity	Each
		3pol 6h	4pol 9h	5pol 9h	3pol 9h	4pol 6h	5pol 6h		
16	4			1012			10	400	
16	5				107			10	410
32 ¹⁾	5				108			10	465

16A		32A	
4p	5p	4p	5p
a	154 155	156 157	
b	127 130	130 136	

TK-Combi Socket

- With terminals, with wiring (ready wired for installation)
- With integrated domestic socket 16A/230V ~ (type F - German standard)
- Protection degree IP44

Accessories: see page 79

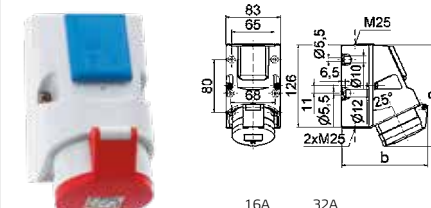

1010

1 MB 17

Amperes	Poles	230V 50-60 Hz			400V 50-60 Hz			Quantity	Each
		3pol 6h	4pol 9h	5pol 9h	3pol 9h	4pol 6h	5pol 6h		
16	4			1013			10	420	
16	5				1010			10	460

16A		32A	
4p	5p	4p	5p
a	154 155	156 157	
b	127 130	130 136	

TK-Combi Socket

- With terminals, with wiring (ready wired for installation)
- With fuse base 5 x 20 mm DIN 41671 and fuse 6,3A
- With integrated domestic socket 16A/230V ~ (type F - German standard)
- Protection degree IP44

²⁾ 2x fuse 6,3A

Accessories: see page 79

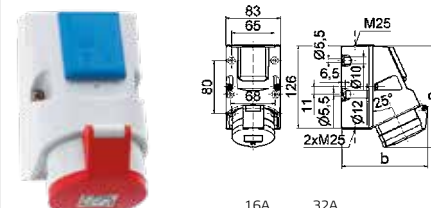

1011

1 MB 17

Amperes	Poles	230V 50-60 Hz			400V 50-60 Hz			Quantity	Each
		3pol 6h	4pol 9h	5pol 9h	3pol 9h	4pol 6h	5pol 6h		
16	5				109			10	500
32 ²⁾	4			1020			10	515	
32	5				1011			10	510

16A		32A	
4p	5p	4p	5p
a	154 155	156 157	
b	127 130	130 136	

TK-Combi Socket

- Belgian/French system
- With terminals, with wiring (ready wired for installation)
- With fuse base 5 x 20 mm DIN 41671 and fuse 6,3A
- With integrated domestic socket 16A/230V ~ (type F - German standard)
- Protection degree IP44

²⁾ 2x fuse 6,3A

Accessories: see page 79

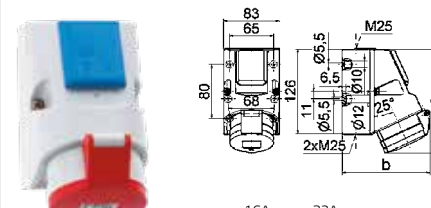

1018

1 MB 17

Amperes	Poles	230V 50-60 Hz			400V 50-60 Hz			Quantity	Each
		3pol 6h	4pol 9h	5pol 9h	3pol 9h	4pol 6h	5pol 6h		
16 ²⁾	4			1017			10	450	
16	5				1015			10	500
32 ²⁾	4			1019			10	515	
32	5				1018			10	510

16A		32A	
4p	5p	4p	5p
a	154 155	156 157	
b	127 130	130 136	

Technical Information

- IEC 60309, EN 60309, VDE 0623
- Particularly suitable for harsh operating conditions, especially resistant to aggressive atmospheres

Surface Mounting Socket Outlet Quick-Connect TE

- Screw terminals
- Kontex contact
- For loopthrough
- High-temperature-resistant contact carrier
- Nickel plated contacts
- Protection degree IP44

Dimension drawing: see page 36/3 (1 MB 2)

QUICK-CONNECT

11990



Amperes	Poles	230V 50-60 Hz	400V 50-60 Hz	500V 50-60 Hz	Quantity	Each
		3pol 4pol 5pol 6h 9h 9h	3pol 4pol 5pol 9h 6h 6h	3pol 4pol 5pol 7h 7h 7h		
16	4	11538	11485	11968	10	320
16	5	11972	11487	11973	10	330
32	3	11977	11978	11979	10	360
32	4	11983	11984	11985	10	380
32	5	11989	11990	11991	10	420

Surface Mounting Socket Outlet TE

- Screw terminals
- High-temperature-resistant contact carrier
- Kontex contact and box terminals
- Nickel plated contacts
- Protection degree IP44

Dimension drawing: see page 37/2 (1 MB 4)

11799



Amperes	Poles	230V 50-60 Hz	400V 50-60 Hz	500V 50-60 Hz	Quantity	Each
		3pol 4pol 5pol 6h 9h 9h	3pol 4pol 5pol 9h 6h 6h	3pol 4pol 5pol 7h 7h 7h		
63	3	11796			5	825
63	4		11797	11798	5	885
63	5		11799		5	900

Surface Mounting Socket Outlet QUICK-CONNECT TE

- Screwless terminals
- Kontex contact
- For loopthrough
- High-temperature-resistant contact carrier
- Nickel plated contacts
- Protection degree IP44

QUICK-CONNECT

11451



Amperes	Poles	230V 50-60 Hz	400V 50-60 Hz	500V 50-60 Hz	Quantity	Each
		3pol 4pol 5pol 6h 9h 9h	3pol 4pol 5pol 9h 6h 6h	3pol 4pol 5pol 7h 7h 7h		
16	3	11448			1	410
16	4	11995	11449	110018	1	430
16	5		11451		1	450

Surface Mounting Socket Outlet QUICK-CONNECT TE

- Screwless terminals
- Kontex contact
- For loopthrough
- High-temperature-resistant contact carrier
- Nickel plated contacts
- Protection degree IP44

QUICK-CONNECT

110000



Amperes	Poles	230V 50-60 Hz	400V 50-60 Hz	500V 50-60 Hz	Quantity	Each
		3pol 4pol 5pol 6h 9h 9h	3pol 4pol 5pol 9h 6h 6h	3pol 4pol 5pol 7h 7h 7h		
16	5		110098		1	650
32	3	11997			1	755
32	4	11998	11999	110019	1	770
32	5		110000		1	785

Surface Mounting Socket Outlet TE

- Screw terminals
- For loopthrough
- High-temperature-resistant contact carrier
- Kontex contact and box terminals
- Nickel plated contacts
- Protection degree IP44

Dimension drawing: see page 37/3 (1 MB 28)

11803



Amperes	Poles	230V 50-60 Hz	400V 50-60 Hz	500V 50-60 Hz	Quantity	Each
		3pol 4pol 5pol 6h 9h 9h	3pol 4pol 5pol 9h 6h 6h	3pol 4pol 5pol 7h 7h 7h		
63	3	11800			1	1600
63	4		11801	11802	1	1610
63	5		11803		1	1720

Technical Information

- IEC 60309, EN 60309, VDE 0623
- Particularly suitable for harsh operating conditions, especially resistant to aggressive atmospheres

Surface Mounting Socket Outlet QUICK-CONNECT TE

- Screwless terminals
- Kontex contact
- For loophthrough
- High-temperature-resistant contact carrier
- Nickel plated contacts
- Protection degree IP67

Dimension drawing: see page 38/3 (1 MB 8)

QUICK-CONNECT

11455



Amperage	Poles	230V 50-60 Hz			400V 50-60 Hz			500V 50-60 Hz			Quantity	Each
		3pol 6h	4pol 9h	5pol 9h	3pol 9h	4pol 6h	5pol 6h	3pol 7h	4pol 7h	5pol 7h		
16	3			11452			110387			110388	1	430
16	4			11790			11453			110020	1	450
16	5						11455				1	480

Surface Mounting Socket Outlet QUICK-CONNECT TE

- Screwless terminals
- Kontex contact
- For loophthrough
- High-temperature-resistant contact carrier
- Nickel plated contacts
- Protection degree IP67

Dimension drawing: see page 39/1 (1 MB 14)

QUICK-CONNECT

110017



Amperage	Poles	230V 50-60 Hz			400V 50-60 Hz			500V 50-60 Hz			Quantity	Each
		3pol 6h	4pol 9h	5pol 9h	3pol 9h	4pol 6h	5pol 6h	3pol 7h	4pol 7h	5pol 7h		
32	3			110014							1	825
32	4						110015			110016	1	845
32	5						110017				1	860

Surface Mounting Socket Outlet TE

- Screw terminals
- High-temperature-resistant contact carrier
- Kontex contact and box terminals
- Nickel plated contacts
- Protection degree IP67

Dimension drawing: see page 39/2 (1 MB 3)

11825



Amperage	Poles	230V 50-60 Hz			400V 50-60 Hz			500V 50-60 Hz			Quantity	Each
		3pol 6h	4pol 9h	5pol 9h	3pol 9h	4pol 6h	5pol 6h	3pol 7h	4pol 7h	5pol 7h		
63	3			11822							5	900
63	4						11823			11824	5	920
63	5						11825				5	950

Surface Mounting Socket Outlet TE

- Screw terminals
- For loophthrough
- High-temperature-resistant contact carrier
- Kontex contact and box terminals
- Nickel plated contacts
- Protection degree IP67

Dimension drawing: see page 40/1 (1 MB 15)

11829



Amperage	Poles	230V 50-60 Hz			400V 50-60 Hz			500V 50-60 Hz			Quantity	Each
		3pol 6h	4pol 9h	5pol 9h	3pol 9h	4pol 6h	5pol 6h	3pol 7h	4pol 7h	5pol 7h		
63	3			11826							1	1610
63	4						11827			11828	1	1620
63	5						11829				1	1640

Surface Mounting Socket Outlet TE

- Screw terminals
- High-temperature-resistant contact carrier
- Kontex contact and box terminals
- Nickel plated contacts
- Protection degree IP67

Dimension drawing: see page 40/2 (1 MB 10)

11815



Amperage	Poles	230V 50-60 Hz			400V 50-60 Hz			500V 50-60 Hz			Quantity	Each
		3pol 6h	4pol 9h	5pol 9h	3pol 9h	4pol 6h	5pol 6h	3pol 7h	4pol 7h	5pol 7h		
125	3			11812							1	2850
125	4						11813			11814	1	2900
125	5						11815				1	3195

Surface Mounting Socket Outlet

- With electrical PSC interlocking and additionally M20 at top
- High-temperature-resistant contact carrier
- Kontex contact
- Box terminals
- Protection degree IP44

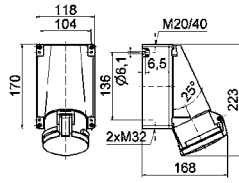

11787

1 MB 36

Amperage	Poles	400V 50-60 Hz			500V 50-60 Hz			Quantity	Each
		3pol 9h	4pol 6h	5pol 6h	3pol 7h	4pol 7h	5pol 7h		
63	4		11785				5	860	
63	5		11787				5	900	

Surface Mounting Socket Outlet

- With electrical PSC interlocking, Contactor and additionally M20 at top
- High-temperature-resistant contact carrier
- Nickel plated contacts
- Kontex contact
- Box terminals
- Protection degree IP44

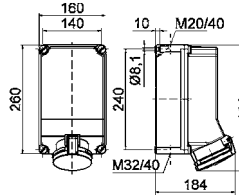

16873

1 MB 38

Amperage	Poles	400V 50-60 Hz			500V 50-60 Hz			Quantity	Each
		3pol 9h	4pol 6h	5pol 6h	3pol 7h	4pol 7h	5pol 7h		
63	4				16871		1	3140	
63	5				16873		1	2920	

Surface Mounting Socket Outlet

- With electrical PSC interlocking and additionally M20 at top
- High-temperature-resistant contact carrier
- Nickel plated contacts
- Kontex contact
- Box terminals
- Protection degree IP67

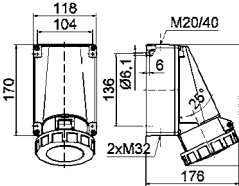

11038

1 MB 31

Amperage	Poles	400V 50-60 Hz			500V 50-60 Hz			Quantity	Each
		3pol 9h	4pol 6h	5pol 6h	3pol 7h	4pol 7h	5pol 7h		
63	4				11052		5	875	
63	5				11038		5	955	

Surface Mounting Socket Outlet

- With electrical PSC interlock, Contactor and additionally M20 at top
- High-temperature-resistant contact carrier
- Nickel plated contacts
- Kontex contact
- Box terminals
- Protection degree IP67

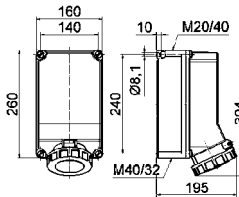

16072

1 MB 32

Amperage	Poles	400V 50-60 Hz			500V 50-60 Hz			Quantity	Each
		3pol 9h	4pol 6h	5pol 6h	3pol 7h	4pol 7h	5pol 7h		
63	4				16070		1		
63	5				16072		1	2915	

Surface Mounting Socket Outlet

- With electrical PSC interlocking and contactor
- High-temperature-resistant contact carrier
- Nickel plated contacts
- Kontex contact
- Box terminals
- Protection degree IP67

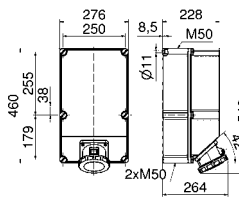

1676

30 MB 104

Amperage	Poles	400V 50-60 Hz			500V 50-60 Hz			Quantity	Each
		3pol 9h	4pol 6h	5pol 6h	3pol 7h	4pol 7h	5pol 7h		
125	4				1674		1	9100	
125	5				1676		1	9115	

Surface Mounting Socket Outlet

- Straight insertion direction
- Cable entry 1x at top (open), 1x at bottom (closed)
- Protection degree IP44

Matching angled plug: see page 86/3



1186

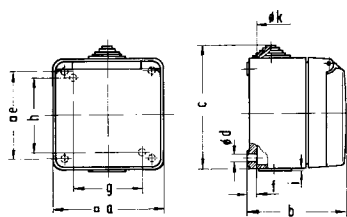

4 MB 16

Ampere	Poles	110V 50-60 Hz			230V 50-60 Hz			400V 50-60 Hz			500V 50-60 Hz			Quantity	Each
		3pol 4h	4pol 4h	5pol 4h	3pol 6h	4pol 9h	5pol 9h	3pol 9h	4pol 6h	5pol 6h	3pol 7h	4pol 7h	5pol 7h		
16	3	11554			1183			1184			10	235			
16	5				1185			1186			11389		10	270	
32	5							11190-BE			5	400			

Ampere	16	16	32
Poles	3	5	5
a	91,0	91,0	91,0
b	79,5	79,5	93,0
c	100,0	100,0	112,5
ø d	5,5	5,5	5,5
e	73,0	73,0	-
f	7,0	7,0	6,0
g	-	-	58,0
ø h	-	-	73,0
i	-	-	1,5
ø k	max 20,0	max 20,0	8,0/20,0



Sockets

Surface Mounting Socket Outlets, fused

Technical Information

- IEC 60309-1/2, EN 60309, VDE 0623
 - Enclosure, window and socket insert made of high-grade plastic

Surface Mounting Socket Outlet

- With Din rail
- 5 modules
- Nickel plated contacts
- Protection degree IP44



15059

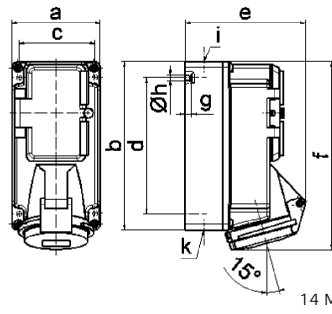

Ampere Poles	16 3	16 4	16 5
a	90,0	90,0	90,0
b	170,0	170,0	170,0
c	77,0	77,0	77,0
d	137,5	137,5	137,5
e	118,0	114,0	121,0
f	188,5	188,5	190,0
g	6,0	6,0	6,0
ø h	5,5	5,5	5,5
i	M20	M20	M20
k	M20/25	M20/25	M20/25

14 MB 3

Protection

	2P+E Ampere	3P+E Poles	110V 50-60 Hz			230V 50-60 Hz			400V 50-60 Hz			500V 50-60 Hz			>50V 100-300Hz			>50V 301-500Hz			Quantity	Each
			3pol 4h	4pol 4h	5pol 4h	3pol 6h	4pol 9h	5pol 9h	3pol 9h	4pol 6h	5pol 6h	3pol 7h	4pol 7h	5pol 7h	3pol 10h	4pol 10h	5pol 10h	3pol 2h	4pol 2h	5pol 2h		
- without fuse protection	16	3	15239			15019												1	505			
	16	4				15095			156									1	520			
	16	5				15096			15059									1	545			
- with 1 or 3-pole fuse base D01	16	3	15382			1500												1				
	16	4				1529			158									1				
	16	5				1530			159									1				
- with 1 or 3-pole C-type MCB	16	3	15384			1504												1				
	16	4				1533			1505									1				
	16	5				1534			1506									1	890			
- with RCCB	16	3	15386			15101												1	705			
25/0,03A 2-pole with 16A 3p	16	4				15102			15103									1				
40/0,03A 4-pole with 16A 4/5p	16	5				15104			15105									1	810			

Surface Mounting Socket Outlet

- With Din rail
- 5 modules
- Nickel plated contacts
- Protection degree IP67



15100

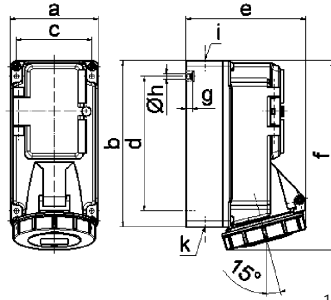

Ampere Poles	16 3	16 4	16 5
a	90,0	90,0	90,0
b	170,0	170,0	170,0
c	77,0	77,0	77,0
d	137,5	137,5	137,5
e	108,0	115,0	121,0
f	191,5	191,5	191,5
g	6,0	6,0	6,0
ø h	5,5	5,5	5,5
i	M20	M20	M20
k	M20/25	M20/25	M20/25

14 MB 6

Protection

	2P+E Ampere	3P+E Poles	110V 50-60 Hz			230V 50-60 Hz			400V 50-60 Hz			500V 50-60 Hz			100-300Hz <50V			100-300Hz <50V			Quantity	Each
			3pol 4h	4pol 4h	5pol 4h	3pol 6h	4pol 9h	5pol 9h	3pol 9h	4pol 6h	5pol 6h	3pol 7h	4pol 7h	5pol 7h	3pol 10h	4pol 10h	5pol 10h	3pol 2h	4pol 2h	5pol 2h		
- without fuse protection	16	3	15240			15024												1	515			
	16	4				15097			15098									1				
	16	5				15099			15100									1	580			
- with 1 or 3-pole fuse base D01	16	3	15383			1501												1				
	16	4				1531			1502									1				
	16	5				1532			1503									1				
- with 1 or 3-pole C-type MCB	16	3	15385			1507												1				
	16	4				1535			1508									1				
	16	5				1536			1509									1				
- with RCCB	16	3	15387			15106												1	725			
25/0,03A 2-pole with 16A 3p	16	4				15107			15108									1				
40/0,03A 4-pole with 16A 4/5p	16	5				15109			15110									1	835			

Technical Information

- IEC 60309-1/2, EN 60309, VDE 0623
- Enclosure, window and socket insert made of high-grade plastic

Surface Mounting Socket Outlet

- With Din rail
- 5 modules
- Nickel plated contacts
- Protection degree IP44



1585

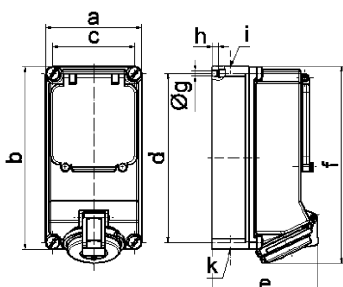

Ampere Poles	16 4	16 5	32 3	32 4	32 5
a	118,0	118,0	118,0	118,0	118,0
b	225,0	225,0	225,0	225,0	225,0
c	101,0	101,0	101,0	101,0	101,0
d	208,0	208,0	208,0	208,0	208,0
e	123,0	130,0	134,0	134,0	141,0
f	242,0	242,0	250,0	250,0	250,0
g	6,5	6,5	6,5	6,5	6,5
ø h	8,0	8,0	8,0	8,0	8,0
i	2xM25	2xM25	2xM25	2xM25	2xM25
k	2xM25	2xM25	2xM25	2xM25	2xM25

Protection

Icon	110V 50-60 Hz	230V 50-60 Hz	400V 50-60 Hz	500V 50-60 Hz	>50V 100-300Hz	>50V 301-500Hz	Quantity	Each
3P+E Ampere Poles	3pol 4h 4h 4h	3pol 4pol 5pol 6h 9h 9h	3pol 4pol 5pol 9h 6h 6h	3pol 4pol 5pol 7h 7h 7h	3pol 4pol 5pol 10h 10h 10h	3pol 4pol 5pol 2h 2h 2h	9	

- without fuse protection

16 4			1582	15044			1	
16 5			1583				1	840
32 3	15029	15030					1	675
32 4			1584	15045			1	
32 5			1585				1	930

- with fuse base D01 for 16A D02 for 32A



16 4			1586				1	
16 5			1587				1	1035
32 3		1537					1	
32 4			1588				1	
32 5			1589				1	1220

- with 3-pole C-type MCB



16 4			1594				1	1185
16 5			1595				1	
32 4			1596				1	
32 5			1597				1	1310

- with RCCB 40/0,03A 4-pole



16 4			15125				1	
16 5			15076				1	1275
32 4			15126				1	1440
32 5			15077				1	1355

Technical Information

- IEC 60309-1/2, EN 60309, VDE 0623
- Enclosure, window and socket insert made of high-grade plastic

Surface Mounting Socket Outlet

- With Din rail
- 5 modules
- Nickel plated contacts
- Protection degree IP67



15112

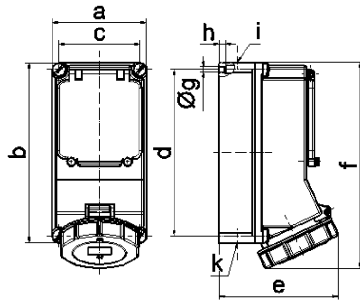

14 MB 12

Ampere Poles	16 4	16 5	32 3	32 4	32 5
a	118,0	118,0	118,0	118,0	118,0
b	225,0	225,0	225,0	225,0	225,0
c	101,0	101,0	101,0	101,0	101,0
d	208,0	208,0	208,0	208,0	208,0
e	127,0	134,0	143,0	143,0	149,0
f	245,0	245,0	255,0	255,0	255,0
g	6,5	6,5	6,5	6,5	6,5
ø h	8,0	8,0	8,0	8,0	8,0
i	2xM25	2xM25	2xM25	2xM25	2xM25
k	2xM25	2xM25	2xM25	2xM25	2xM25

Protection

Protection	Ampere	Poles	110V 50-60 Hz			230V 50-60 Hz			400V 50-60 Hz			500V 50-60 Hz			>50V 100-300Hz			>50V 301-500Hz			Quantity	Each
			3pol 4h	4pol 4h	5pol 4h	3pol 6h	4pol 9h	5pol 9h	3pol 9h	4pol 6h	5pol 6h	3pol 7h	4pol 7h	5pol 7h	3pol 10h	4pol 10h	5pol 10h	3pol 2h	4pol 2h	5pol 2h		
	16	4							15027	15176									1	950		
	16	5							15028										1	980		
- without fuse protection	32	3	15388			15352													1	1000		
	32	4							15111	15177									1	1020		
	32	5							15112										1	1160		
- with fuse base D01 for 16A D02 for 32A	16	4							15113										1	1150		
	16	5							15114										1	1180		
	32	3				1565													1	1200		
	32	4							15115										1	1220		
	32	5							15116										1	1360		
- with 3-pole C-type MCB	16	4							15121										1	1250		
	16	5							15122										1	1280		
	32	4							15123										1	1320		
	32	5							15124										1	1460		
- with RCCB 40/0,03A 4-pole	16	4							15127										1	1410		
	16	5							15078										1	1440		
	32	4							15128										1	1480		
	32	5							15079										1	1520		

Technical Information

- IEC 60309-1/2, EN 60309, VDE 0623
- Enclosure, window and socket insert made of high-grade plastic

Surface Mounting Socket Outlet

- With Din rail
- 7 modules
- 63A with box terminals and Kontex contact
- Nickel plated contacts
- Protection degree IP44
- Products with PILOT please add "P" to the ref. no.



15036

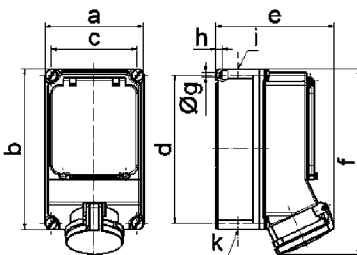

14 MB 14

Ampere Poles	32 4	32 5	63 3	63 4	63 5
a	160,0	160,0	160,0	160,0	160,0
b	260,0	260,0	260,0	260,0	260,0
c	140,0	140,0	140,0	140,0	140,0
d	240,0	240,0	240,0	240,0	240,0
e	160,0	168,0	185,0	185,0	185,0
f	286,0	286,0	303,0	303,0	303,0
ø g	8,1	8,1	8,1	8,1	8,1
h	10,0	10,0	10,0	10,0	10,0
i	M40	M40	M40	M40	M40
k	M32/40	M32/40	M32/40	M32/40	M32/40

Protection

3P+E Ampere	3P+E Poles	3P+N+E Ampere	3P+N+E Poles	110V 50-60 Hz	230V 50-60 Hz	400V 50-60 Hz	500V 50-60 Hz	>50V 100-300Hz	>50V 301-500Hz	Quantity	Each
32	4			3pol 4h	4pol 4h	5pol 4h	3pol 7h	4pol 7h	5pol 7h	9	
32	5			3pol 6h	4pol 9h	5pol 9h	3pol 7h	4pol 7h	5pol 7h		
63	3							3pol 10h	4pol 10h	5pol 10h	1
63	4							3pol 2h	4pol 2h	5pol 2h	1
63	5							3pol 2h	4pol 2h	5pol 2h	1

- without fuse protection

32	4					15129	15172			1	
32	5					15130				1	
63	3					15052				1	
63	4					15035				1	
63	5					15036				1	2165

- with fuse base D02



32	4					15131				1	
32	5					15132				1	
63	3					15058				1	
63	4					15081				1	
63	5					15082				1	2165

- with 3-pole C-type MCB



32	4					15138				1	
32	5					15139				1	
63	4					15140				1	
63	5					15141				1	

- with RCCB
40/0,03A 4-pole for 32A
63/0,03A 4-pole for 63A



32	4					15146				1	
32	5					15147				1	1915
63	4					15148				1	
63	5					15017				1	2251

Sockets

Surface Mounting Socket Outlets, fused

Technical Information

- IEC 60309-1/2, EN 60309, VDE 0623
- Enclosure, window and socket insert made of high-grade plastic

Surface Mounting Socket Outlet

- With Din rail
- 7 modules
- 63A with box terminals and Kontex contact
- Nickel plated contacts
- Protection degree IP67
- Products with PILOT please add "P" to the ref. no.



15001

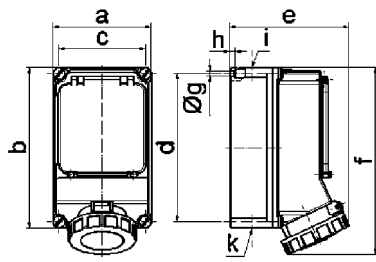

14 MB 11

Ampere Poles	32 4	32 5	63 4	63 5
a	160,0	160,0	160,0	160,0
b	260,0	260,0	260,0	260,0
c	140,0	140,0	140,0	140,0
d	240,0	240,0	240,0	240,0
e	172,0	174,0	195,0	195,0
f	293,0	294,0	304,0	304,0
ø g	8,1	8,1	8,1	8,1
h	10,0	10,0	10,0	10,0
i	M40	M40	M40	M40
k	M32/40	M32/40	M32/40	M32/40

Protection

2P+E Amperes	3P+E Poles	3+N+E Poles	110V 50-60 Hz 3pol 4pol 5pol 4h 4h 4h	230V 50-60 Hz 3pol 4pol 5pol 6h 9h 9h	400V 50-60 Hz 3pol 4pol 5pol 9h 6h 6h	500V 50-60 Hz 3pol 4pol 5pol 7h 7h 7h	>50V 100-300Hz 3pol 4pol 5pol 10h 10h 10h	>50V 301-500Hz 3pol 4pol 5pol 2h 2h 2h	Quantity	Each
-----------------	---------------	----------------	--	--	--	--	--	---	----------	------

- without fuse protection

32	4				1598	15174			1	
32	5				1599				1	
63	4				15000	15175			1	1850
63	5				15001				1	1950

- with fuse base D02



32	4				15133				1	
32	5				15134				1	
63	4				15083				1	
63	5				15013				1	

- with 3-pole C-type MCB



32	4				15142				1	
32	5				15143				1	
63	4				15144				1	
63	5				15145				1	

- with RCCB
40/0,03A 4-pole for 32A
63/0,03A 4-pole for 63A



32	4				15149				1	
32	5				15150				1	1970
63	4				15151				1	
63	5				15080				1	2315

Technical Information

- IEC 60309-1/2, EN 60309, VDE 0623
- Enclosure, window and socket insert made of high-grade plastic

Surface Mounting Socket Outlet

- With Din rail
- 8 modules
- Kontex contact
- Nickel plated contacts
- Box terminals
- Protection degree IP44
- Products with PILOT please add "P" to the ref. no.



15038

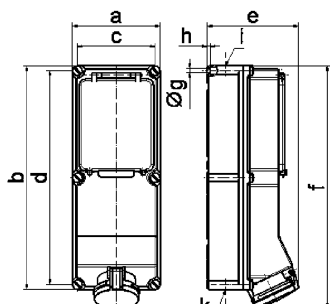

14 MB 15

Ampere Poles	63 4	63 5
a	180,0	180,0
b	460,0	460,0
c	160,0	160,0
d	440,0	440,0
e	182,0	182,0
f	498,0	498,0
ø g	8,3	8,3
h	6,5	6,5
i	M40	M40
k	M32/40	M32/40

Protection

			110V 50-60 Hz	230V 50-60 Hz	400V 50-60 Hz	500V 50-60 Hz	>50V 100-300Hz	>50V 301-500Hz		9
3pole 4pole 5pole	3pole 4pole 5pole	3pole 4pole 5pole	4h 4h 4h	6h 9h 9h	9h 6h 6h	3pole 4pole 5pole	3pole 4pole 5pole	3pole 4pole 5pole	Quantity	Each

- without fuse protection

63	4	15155	15156	1	3800
63	5	15038		1	2830

- with load-break switch NH00



63	4	15152	15153	1	
63	5	15154		1	3390

- with RCCB
63/0,03A 4-pole for 63A



63	4	15161		1	
63	5	15162		1	

- with RCCB
63/0,03A 4-pole for 63A



63	4	15163		1	
63	5	15164		1	

Technical Information

- IEC 60309-1/2, EN 60309, VDE 0623
 - Enclosure and socket insert made of high-grade plastic

Surface Mounting Socket Outlet

- With Din rail
- 8 modules
- Kontex contact
- Box terminals
- Nickel plated contacts
- Protection degree IP67
- Products with PILOT please add "P" to the ref. no.



15047

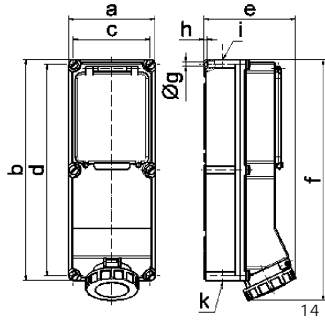

Ampere Poles	63 3	63 4	63 5	125 4	125 5
a	180,0	180,0	180,0	180,0	180,0
b	460,0	460,0	460,0	460,0	460,0
c	160,0	160,0	160,0	160,0	160,0
d	440,0	440,0	440,0	440,0	440,0
e	191,0	191,0	191,0	210,0	210,0
f	500,0	500,0	500,0	512,0	512,0
ø g	8,3	8,3	8,3	8,3	8,3
h	6,5	6,5	6,5	6,5	6,5
i	M40	M40	M40	M40	M40
k	M32/40	M32/40	M32/40	M40/50	M40/50

Protection

			110V 50-60 Hz	230V 50-60 Hz	400V 50-60 Hz	500V 50-60 Hz	>50V 100-300Hz	>50V 301-500Hz		9
Ampere	Poles		3pol 4pol 5pol 4h 4h 4h	3pol 4pol 5pol 6h 9h 9h	3pol 4pol 5pol 9h 6h 6h	3pol 4pol 5pol 7h 7h 7h	3pol 4pol 5pol 10h 10h 10h	3pol 4pol 5pol 2h 2h 2h	Quantity	Each

- without fuse protection

63	3	15072							1	
63	4			1580	15157				1	2890
63	5			15047						
125	4				15158	15159			1	
125	5				15160				1	3800

- with RCCB
 63/0,03A 4-pole for 63A
 125/0,3A 4-pole for 125A



63	4				15165				1	
63	5				15166				1	3285
125	4					15169			1	
125	5					15170			1	3960

- with RCCB
 63/0,3A 4-pole for 63A
 125/0,5A 4-pole for 125A



63	4					15167			1	
63	5					15168			1	
125	4					15171			1	
125	5					15075			1	

Surface Mounting Socket Outlet

- Kontex contact
- Box terminals
- Nickel plated contacts
- Protection degree IP67
- Products with PILOT please add "P" to the ref. no.



15009

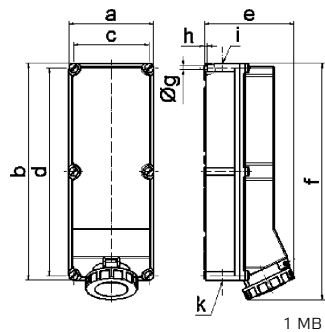

Ampere Poles	63 4	63 5	125 4	125 5
a	180,0	180,0	180,0	180,0
b	460,0	460,0	460,0	460,0
c	160,0	160,0	160,0	160,0
d	440,0	440,0	440,0	440,0
e	191,0	191,0	210,0	210,0
f	500,0	500,0	512,0	512,0
ø g	8,3	8,3	8,3	8,3
h	6,5	6,5	6,5	6,5
i	M40	M40	M40	M40
k	M32/40	M32/40	M40/50	M40/50

Protection

			110V 50-60 Hz	230V 50-60 Hz	400V 50-60 Hz	500V 50-60 Hz	>50V 100-300Hz	>50V 301-500Hz		9
Ampere	Poles		3pol 4pol 5pol 4h 4h 4h	3pol 4pol 5pol 6h 9h 9h	3pol 4pol 5pol 9h 6h 6h	3pol 4pol 5pol 7h 7h 7h	3pol 4pol 5pol 10h 10h 10h	3pol 4pol 5pol 2h 2h 2h	Quantity	Each

- with load-break switch NH00



63	4				15006	15042			1	
63	5				15007				1	3455
125	4					15008	15043		1	3715
125	5					15009			1	4030

Technical Information

- IEC 60309-1/2, EN 60309, VDE 0623
- Enclosure and socket insert made of high-grade plastic

Surface Mounting Socket Outlet

- Switched
- Lockable in 0-position
- With mechanical double interlocking
- Nickel plated contacts
- Protection degree IP44
- as switchable version available on request

Ampere	Poles	110V	230V	400V	500V	>50V	>50V	Quantity	Each
		50-60 Hz	50-60 Hz	50-60 Hz	50-60 Hz	100-300Hz	301-500Hz		
16	3	16008	1619					1	575
16	4		1641	1610	1616			1	605
16	5		1642	1611				1	615



1611

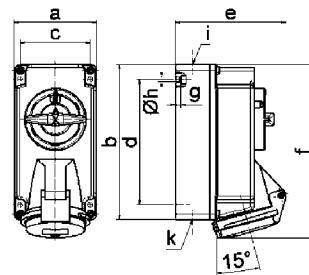

12 MB 3

Ampere Poles	16 3	16 4	16 5
a	90,0	90,0	90,0
b	170,0	170,0	170,0
c	77,0	77,0	77,0
d	137,5	137,5	137,5
e	108,0	114,0	121,0
f	188,5	188,5	190,0
g	6,0	6,0	6,0
h	5,5	5,5	5,5
i	M20	M20	M20
k	M20/25	M20/25	M20/25

Surface Mounting Socket Outlet

- Switched
- Lockable in 0-position
- With mechanical double interlocking
- Nickel plated contacts
- Protection degree IP44
- as switchable version available on request

Ampere	Poles	110V	230V	400V	500V	>50V	>50V	Quantity	Each
		50-60 Hz	50-60 Hz	50-60 Hz	50-60 Hz	100-300Hz	301-500Hz		
16	4	16058	16038	16064				1	980
16	5		16039					1	1010
32	3	16123	16097					1	1160
32	4		16060	16042	16066			1	1205
32	5			16043				1	1210



16039

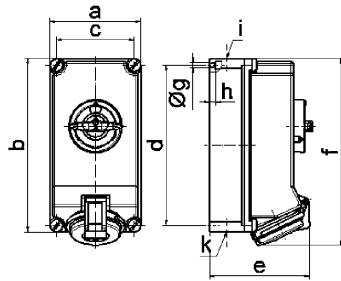

12 MB 24

Ampere Poles	16 4	16 5	32 3	32 4	32 5
a	118,0	118,0	118,0	118,0	118,0
b	225,0	225,0	225,0	225,0	225,0
c	101,0	101,0	101,0	101,0	101,0
d	208,0	208,0	208,0	208,0	208,0
e	126,0	134,0	137,0	137,0	144,0
f	242,0	242,0	251,0	251,0	251,0
g	6,5	6,5	6,5	6,5	6,5
h	8,0	8,0	8,0	8,0	8,0
i	2xM25	2xM25	2xM25	2xM25	2xM25
k	2xM25	2xM25	2xM25	2xM25	2xM25

Surface Mounting Socket Outlet

- Switched
- Lockable in 0-position
- With mechanical double interlocking
- Nickel plated contacts
- Box terminals
- Protection degree IP44
- Products with PILOT please add "P" to the ref. no.
- as switchable version available on request

Ampere	Poles	110V	230V	400V	500V	>50V	>50V	Quantity	Each
		50-60 Hz	50-60 Hz	50-60 Hz	50-60 Hz	100-300Hz	301-500Hz		
63	3	16093	16956					1	2025
63	4		16933	16605	16827			1	2150
63	5			16603	16721			1	2245



16603

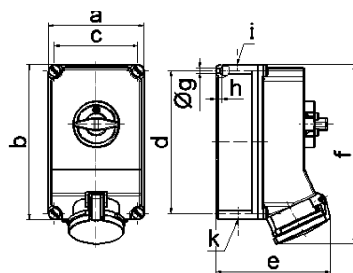

12 MB 30

Ampere Poles	63 3	63 4	63 5
a	160,0	160,0	160,0
b	260,0	260,0	260,0
c	140,0	140,0	140,0
d	240,0	240,0	240,0
e	184,0	184,0	184,0
f	302,0	302,0	302,0
g	8,1	8,1	8,1
h	10,0	10,0	10,0
i	M40	M40	M40
k	M32/40	M32/40	M32/40

Sockets

Surface Mounting Socket Outlets, switched, interlocked

Technical Information

- IEC 60309-1/2, EN 60309, VDE 0623
 - Enclosure and socket insert made of high-grade plastic

Surface Mounting Socket Outlet

- Switched
- Lockable in 0-position
- With mechanical double interlocking
- Nickel plated contacts
- Protection degree IP67
- as switchable version available on request

Ampere	Poles	110V	230V	400V	500V	>50V	>50V	Quantity	g	Each
		50-60 Hz	50-60 Hz	50-60 Hz	50-60 Hz	100-300Hz	301-500Hz			
16	3	16138	160048	160056				1	600	
16	4		160053	160049	160057			1	625	
16	5		160055	160052	160058			1	640	



160052

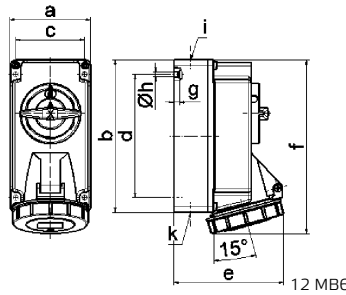

Ampere Poles	16 3	16 4	16 5
a	90,0	90,0	90,0
b	170,0	170,0	170,0
c	77,0	77,0	77,0
d	137,5	137,5	137,5
e	108,0	115,0	121,0
f	191,5	191,5	191,5
g	6,0	6,0	6,0
ø h	5,5	5,5	5,5
i	M20	M20	M20
k	M20/25	M20/25	M20/25

Surface Mounting Socket Outlet

- Switched
- Lockable in 0-position
- With mechanical double interlocking
- Nickel plated contacts
- Protection degree IP67
- as switchable version available on request

Ampere	Poles	110V	230V	400V	500V	>50V	>50V	Quantity	g	Each
		50-60 Hz	50-60 Hz	50-60 Hz	50-60 Hz	100-300Hz	301-500Hz			
16	4		16059	16040	16065			1	1020	
16	5			16041				1	1050	
32	3	16124	16104					1	1275	
32	4		16875	160178	160179			1	1255	
32	5			160177				1	1325	



16041

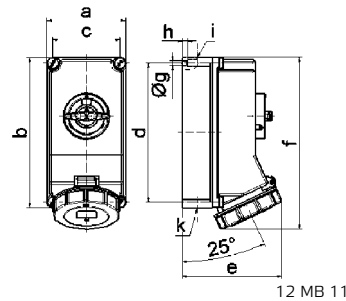

Ampere Poles	16 4	16 5	32 3	32 4	32 5
a	118,0	118,0	118,0	118,0	118,0
b	225,0	225,0	225,0	225,0	225,0
c	101,0	101,0	101,0	101,0	101,0
d	208,0	208,0	208,0	208,0	208,0
e	127,0	134,0	143,0	143,0	149,0
f	245,0	245,0	255,0	255,0	255,0
ø g	6,5	6,5	6,5	6,5	6,5
h	8,0	8,0	8,0	8,0	8,0
i	2xM25	2xM25	2xM25	2xM25	2xM25
k	2xM25	2xM25	2xM25	2xM25	2xM25

Surface Mounting Socket

- Switched
- Lockable in 0-position
- With mechanical double interlocking
- Kontex contact
- Nickel plated contacts
- Box terminals
- Protection degree IP67
- Products with PILOT please add "P" to the ref. no.
- as switchable version available on request

Ampere	Poles	110V	230V	400V	500V	>50V	>50V	Quantity	g	Each
		50-60 Hz	50-60 Hz	50-60 Hz	50-60 Hz	100-300Hz	301-500Hz			
63	3	16125	16606					1	2135	
63	4		16934	16604	16828			1	2200	
63	5			16602	160290			1	2300	



16602

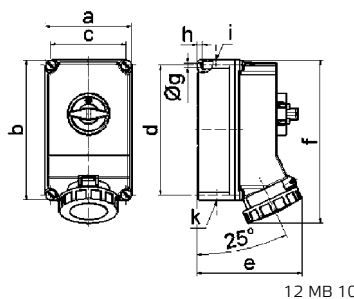

Ampere Poles	63 3	63 4	63 5
a	160,0	160,0	160,0
b	260,0	260,0	260,0
c	140,0	140,0	140,0
d	240,0	240,0	240,0
e	195,0	195,0	195,0
f	304,0	304,0	304,0
ø g	8,1	8,1	8,1
h	10,0	10,0	10,0
i	M40	M40	M40
k	M32/40	M32/40	M32/40

Technical Information

- IEC 60309-1/2, EN 60309, VDE 0623
- Enclosure and socket insert made of high-grade plastic

Surface Mounting Socket Outlet

- Switched
- Lockable in 0-position
- With mechanical double interlocking
- Kontex contact
- Nickel plated contacts
- Box terminals
- Protection degree IP67
- as switchable version available on request



110V
50-60 Hz
3pol 4pol 5pol
4h 4h 4h

230V
50-60 Hz
3pol 4pol 5pol
6h 9h 9h

400V
50-60 Hz
3pol 4pol 5pol
9h 6h 6h

500V
50-60 Hz
3pol 4pol 5pol
7h 7h 7h

>50V
100-300Hz
3pol 4pol 5pol
10h 10h 10h

>50V
301-500Hz
3pol 4pol 5pol
2h 2h 2h

9
Quantity Each

125	3	16620		1	3605
125	4	16930	16621	16831	1 3635
125	5		16622		1 3950



16622

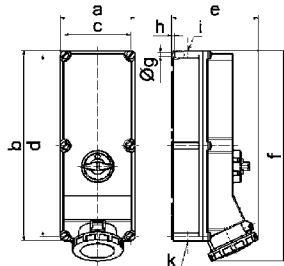

Ampere Poles	125 3	125 4	125 5
a	180,0	180,0	180,0
b	460,0	460,0	460,0
c	160,0	160,0	160,0
d	440,0	440,0	440,0
e	208,0	208,0	208,0
f	510,0	510,0	510,0
ø g	8,3	8,3	8,3
h	6,5	6,5	6,5
i	M40	M40	M40
k	M40/50	M40/50	M40/50

12 MB 5

Surface Mounting Socket Outlet

- Switched
- Lockable in 0-position
- With mechanical double interlocking
- Kontex contact
- Nickel plated contacts
- Box terminals
- Terminals 5x 50mm²
- Protection degree IP67



110V
50-60 Hz
3pol 4pol 5pol
4h 4h 4h

230V
50-60 Hz
3pol 4pol 5pol
6h 9h 9h

400V
50-60 Hz
3pol 4pol 5pol
9h 6h 6h

500V
50-60 Hz
3pol 4pol 5pol
7h 7h 7h

>50V
100-300Hz
3pol 4pol 5pol
10h 10h 10h

>50V
301-500Hz
3pol 4pol 5pol
2h 2h 2h

9
Quantity Each

125	5	51010578			
-----	---	-----------------	--	--	--

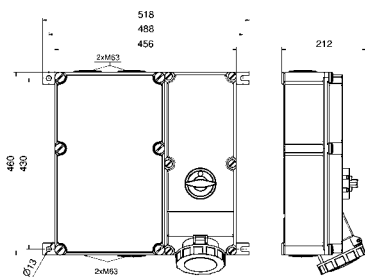

Z131190

Sockets

Surface Mounting Socket Outlets, switched, fused

Technical Information

- IEC 60309-1/2, EN 60309, VDE 0623
- Enclosure, window and socket insert made of high-grade plastic

Surface Mounting Socket Outlet

- Switched
- Lockable in 0-position
- With Din rail
- 6 modules for 16A and 32A, 8 modules for 63A
- 63A with box terminals and Kontex contact
- Nickel plated contacts
- Protection degree IP44
- Products with PILOT please add "P" to the ref. no.



17060

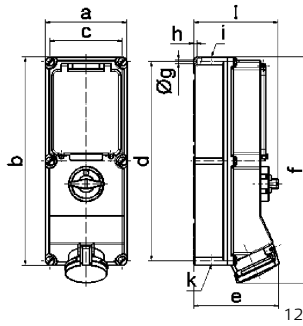

Ampere Poles	16 4	16 5	32 4	32 5	63 4	63 5
a	134,0	134,0	134,0	134,0	180,0	180,0
b	365,0	365,0	365,0	365,0	460,0	460,0
c	117,0	117,0	117,0	117,0	160,0	160,0
d	348,0	348,0	348,0	348,0	440,0	440,0
e	135,0	141,0	146,0	152,0	184,0	184,0
f	382,0	382,0	391,0	391,0	500,0	500,0
ø g	6,5	6,5	6,5	6,5	8,3	8,3
h	8,0	8,0	8,0	8,0	6,5	6,5
i	M25/32	M25/32	M32/40	M32/40	M40	M40
k	M25/32	M25/32	M32/40	M32/40	M32/40	M32/40
l	156,0	156,0	156,0	156,0	189,0	189,0

Protection

	110V 50-60 Hz	230V 50-60 Hz	400V 50-60 Hz	500V 50-60 Hz	>50V 100-300Hz	>50V 301-500Hz		g
Ampere Poles	3pol 4pol 5pol 4h 4h 4h	3pol 4pol 5pol 6h 9h 9h	3pol 4pol 5pol 9h 6h 6h	3pol 4pol 5pol 7h 7h 7h	3pol 4pol 5pol 10h 10h 10h	3pol 4pol 5pol 2h 2h 2h	Quantity	Each

- without fuse protection

16	4	17275	17055	17337		1
16	5		17056			1 1630
32	4	17276	17057	17338		1 1700
32	5		17058			1 1750
63	4	17277	17059	17339		1
63	5		17060	17847		1

- with fuse base
D01 for 16A
D02 for 32A and 63A



16	4	17027	1775			1 1775
16	5		1776			1 1830
32	4	17028	1777			1
32	5		1778			1 2160
63	4	176	174			1
63	5	177	175			1 3495

- with fuse base
DII for 16A
DIII for 32A and 63A



16	4	17032	1783	17233		1
16	5		1784			1
32	4	17033	1785	17234		1
32	5		1786			1 2230
63	4	1734	178	1736		1
63	5	1735	179			1 3795

- with 3-pole C-type MCB



16	4	17280	17281			1
16	5		17282			1 1960
32	4	17283	17284			1
32	5		17285			1
63	4	17286	17287			1
63	5		17288			1

- with C-type MCB and RCCB
40/0,03A for 16A and 32A



16	4	17298	17299			1
16	5		17300			1 2350
32	4	17301	17302			1

- with D02 and RCCB 63/0,03A
for 63A



32	5		17303			1 2675
63	4	17304	17305			1
63	5		17306			1 3955

- with load-break switch NH00



63	4	17037	1793	17335		1
63	5		1794			1

Technical Information

- IEC 60309-1/2, EN 60309, VDE 0623
- Enclosure, window and socket insert made of high-grade plastic

Surface Mounting Socket Outlet

- Switched
- Lockable in 0-position
- With Din rail
- 6 modules for 16A and 32A, 8 modules for 63A
- 63A with box terminals and Kontex contact
- Nickel plated contacts
- Protection degree IP67
- Products with PILOT please add "P" to the ref. no.

17066

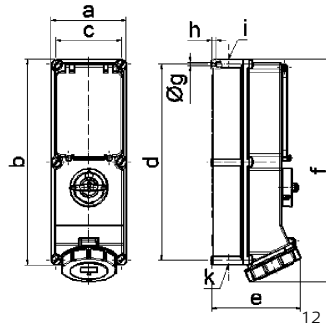

Ampere Poles	16 4	16 5	32 4	32 5	63 4	63 5
a	134,0	134,0	134,0	134,0	180,0	180,0
b	365,0	365,0	365,0	365,0	460,0	460,0
c	117,0	117,0	117,0	117,0	160,0	160,0
d	348,0	348,0	348,0	348,0	440,0	440,0
e	136,0	143,0	152,0	158,0	191,0	191,0
f	389,0	389,0	399,0	399,0	500,0	500,0
Øg	6,5	6,5	6,5	6,5	8,3	8,3
h	8,0	8,0	8,0	8,0	6,5	6,5
i	M25/32	M25/32	M32/40	M32/40	M40	M40
k	M25/32	M25/32	M32/40	M32/40	M32/40	M32/40

12 MB 12

Protection

2P+E	3P+E	3+N+E	110V 50-60 Hz	230V 50-60 Hz	400V 50-60 Hz	500V 50-60 Hz	>50V 100-300Hz	>50V 301-500Hz	Quantity	Each															
3pol	4pol	5pol	4h	4h	4h	3pol	4pol	5pol	7h	7h	7h	3pol	4pol	5pol	10h	10h	10h	3pol	4pol	5pol	2h	2h	2h	9	Each

- without fuse protection

16	4	17278	17061	17340	1
16	5	17062	1	1675	
32	4	17162	17063	17341	1
32	5	17064	1	1800	
63	4	17279	17065	17342	1
63	5	17066	1	3280	

- with fuse base
D01 for 16A
D02 for 32A and 63A



16	4	17029	1779	1
16	5	1780	1	
32	4	17030	1781	1
32	5	1782	1	
63	4	17031	1791	1
63	5	1792	1	

- with fuse base
DII for 16A
DIII for 32A and 63A



16	4	17034	1787	17334	1
16	5	1788	1		
32	4	17035	1789	17238	1
32	5	1790	1		
63	4	17036	1771	1773	1
63	5	1770	1		

- with 3-pole C-type MCB



16	4	17289	17290	1
16	5	17291	1	2000
32	4	17292	17293	1
32	5	17294	1	
63	4	17295	17296	1
63	5	17297	1	3715

- with C-type MCB and RCCB
40/0,03A for 16A and 32A



16	4	17307	17308	1
16	5	17309	1	
32	4	17310	17311	1

- with D02 and RCCB 63/0,03A
for 63A



32	5	17312	1	3965
63	4	17313	17314	1
63	5	17315	1	

- with load-break switch NH00



63	4	17038	1795	17336	1
63	5	1796	1		

Sockets

Surface Mounting Socket Outlets, switched, interlocked and fused

Technical Information

- IEC 60309-1/2, EN 60309, VDE 0623
- Enclosure, window and socket insert made of high-grade plastic

Surface Mounting Socket Outlet

- Switched, Interlocked
- Lockable in 0-position
- With Din rail
- 6 modules for 16A and 32A, 8 modules for 63A
- 63A with box terminals and Kontex contact
- Nickel plated contacts
- Protection degree IP44
- Products with PILOT please add "P" to the ref.no.



17524

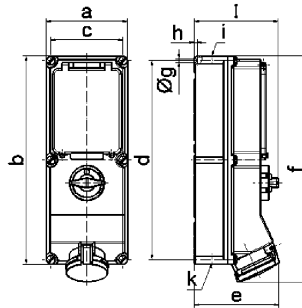

12 MB 21

Ampere Poles	16 4	16 5	32 4	32 5	63 4	63 5
a	134,0	134,0	134,0	134,0	180,0	180,0
b	365,0	365,0	365,0	365,0	460,0	460,0
c	117,0	117,0	117,0	117,0	160,0	160,0
d	348,0	348,0	348,0	348,0	440,0	440,0
e	135,0	141,0	146,0	152,0	184,0	184,0
f	382,0	382,0	391,0	391,0	500,0	500,0
ø g	6,5	6,5	6,5	6,5	8,3	8,3
h	8,0	8,0	8,0	8,0	6,5	6,5
i	M25/32	M25/32	M32/40	M32/40	M40	M40
k	M25/32	M25/32	M32/40	M32/40	M32/40	M32/40
l	156,0	156,0	156,0	156,0	189,0	189,0

Protection



110V
50-60 Hz

230V
50-60 Hz

400V
50-60 Hz

500V
50-60 Hz

>50V
100-300Hz

>50V
301-500Hz



- without fuse protection

Ampere	Poles	110V 50-60 Hz	230V 50-60 Hz	400V 50-60 Hz	500V 50-60 Hz	>50V 100-300Hz	>50V 301-500Hz	Quantity	Each
16	3		17087					1	
16	4		17165	17164	17166			1	1650
16	5			17163				1	
32	3		17107						
32	4		17167	17168	17169			1	1855
32	5			17170				1	1960
63	3		17134						
63	4		17521	17522	17523			1	3205
63	5			17524				1	3450

- with fuse base
D01 for 16A
D02 for 32A and 63A



16	4		17039	1797				1	
16	5			1798				1	
32	4		17040	1799				1	
32	5			17000				1	
63	4		17525	17526				1	
63	5			17527				1	3720

- with fuse base
DII for 16A
DIII for 32A and 63A



16	4		17044	17007	17019			1	2005
16	5			17008				1	
32	4		17045	17009	17020			1	2390
32	5			17010				1	
63	4		17528	17529	17530			1	3740
63	5			17531				1	

- with 3-pole C-type MCB



16	4		17316	17186				1	
16	5			17187				1	
32	4		17317	17188				1	
32	5			17189				1	
63	4		17532	17533				1	
63	5			17534				1	

- with C-type MCB and RCCB
40/0,03A for 16A and 32A



16	4		17322	17323				1	
16	5			17343				1	2430
32	4		17324	17325				1	

- with D02 and RCCB 63/0,03A for 63A



32	5			17344				1	2650
63	4		17535	17536				1	
63	5			17537				1	

- with load-break switch NH00



63	4		17555	17556	17557			1	3705
63	5			17558				1	

Surface Mounting Socket Outlets, switched, interlocked, fused

Technical Information

- IEC 60309-1/2, EN 60309, VDE 0623
- Enclosure, window and socket insert made of high-grade plastic

Surface Mounting Socket Outlet

- Switched, Interlocked
- Lockable in 0-position
- With Din rail
- 6 modules for 16A and 32A, 8 modules for 63A
- 63A with box terminals and Kontex contact
- Nickel plated contacts
- Protection degree IP67
- Products with PILOT please add "P" to the ref.no.

17541

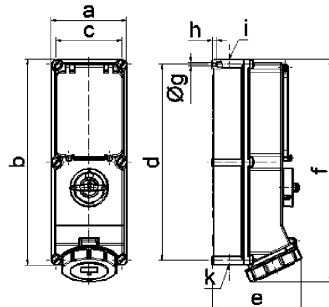

Ampere Poles	16 4	16 5	32 4	32 5	63 4	63 5
a	134,0	134,0	134,0	134,0	180,0	180,0
b	365,0	365,0	365,0	365,0	460,0	460,0
c	117,0	117,0	117,0	117,0	160,0	160,0
d	348,0	348,0	348,0	348,0	440,0	440,0
e	136,0	143,0	152,0	158,0	191,0	191,0
f	389,0	389,0	399,0	399,0	500,0	500,0
Ø g	6,5	6,5	6,5	6,5	8,3	8,3
h	8,0	8,0	8,0	8,0	6,5	6,5
i	M25/32	M25/32	M32/40	M32/40	M40	M40
k	M25/32	M25/32	M32/40	M32/40	M32/40	M32/40

12 MB 12

Protection



110V 50-60 Hz

230V 50-60 Hz

400V 50-60 Hz

500V 50-60 Hz

>50V 100-300Hz

>50V 301-500Hz



Quantity Each

- without fuse protection

16	3	17387					
16	4	17175	17176	17177		1	1685
16	5		17178			1	1735
32	3	17213					
32	4	17179	17180	17181		1	1900
32	5		17182			1	2033
63	3	17216					
63	4	17538	17539	17540		1	3260
63	5		17541			1	3415

- with fuse base D01 for 16A D02 for 32A and 63A



16	4	17041	17001			1	
16	5		17002			1	
32	4	17042	17003			1	
32	5		17004			1	
63	4	17542	17543			1	
63	5		17544			1	

- with fuse base DII for 16A DIII for 32A and 63A



16	4	17046	17011	17021		1	
16	5		17012			1	
32	4	17047	17013	17022		1	
32	5		17014			1	
63	4	17545	17546	17547		1	3790
63	5		17548			1	

- with 3-pole C-type MCB



16	4	17319	17192			1	
16	5		17193			1	
32	4	17320	17194			1	
32	5		17195			1	2305
63	4	17549	17550			1	
63	5		17551			1	

- with C-type MCB and RCCB 40/0,03A for 16A and 32A



16	4	17328	17329			1	
16	5		17345			1	2450
32	4	17330	17331			1	

- with D02 and RCCB 63/0,03A for 63A



32	5		17346			1	
63	4	17552	17553			1	
63	5		17554			1	4240

- with load-break switch NH00



63	4	17559	17560	17561		1	
63	5		17562			1	3880

Sockets

Surface Mounting Socket Outlets, switched, interlocked

Technical Information

- IEC 60309, EN 60309, VDE 0623
- Particularly suitable for harsh operating conditions, especially resistant to aggressive atmospheres

Surface Mounting Socket Outlet

- Switched
- With mechanical double interlocking
- Lockable in 0-position
- High-temperature-resistant contact carrier
- Nickel plated contacts
- Protection degree IP44

Dimension drawing: see page 53/1 (12 MB 3)



16907

2P+E Ampere	3P+E Poles	230V 50-60 Hz			400V 50-60 Hz			500V 50-60 Hz			Quantity	g
		3pol 6h	4pol 9h	5pol 9h	3pol 9h	4pol 6h	5pol 6h	3pol 7h	4pol 7h	5pol 7h		
16	5				16906	16907				1	655	

Surface Mounting Socket Outlet

- Switched
- With mechanical double interlocking
- Lockable in 0-position
- High-temperature-resistant contact carrier
- Nickel plated contacts
- Protection degree IP44

Dimension drawing: see page 53/2 (12 MB 24)



2P+E Ampere	3P+E Poles	230V 50-60 Hz			400V 50-60 Hz			500V 50-60 Hz			Quantity	g
		3pol 6h	4pol 9h	5pol 9h	3pol 9h	4pol 6h	5pol 6h	3pol 7h	4pol 7h	5pol 7h		
16	5				16180					1	1010	

Surface Mounting Socket Outlet

- Switched
- With mechanical double interlocking
- Lockable in 0-position
- High-temperature-resistant contact carrier
- Nickel plated contacts
- Protection degree IP44

Dimension drawing: see page 53/2 (12 MB 24)



2P+E Ampere	3P+E Poles	230V 50-60 Hz			400V 50-60 Hz			500V 50-60 Hz			Quantity	g
		3pol 6h	4pol 9h	5pol 9h	3pol 9h	4pol 6h	5pol 6h	3pol 7h	4pol 7h	5pol 7h		
32	5				16181					1	1295	

Surface Mounting Socket Outlet

- Switched
- With mechanical double interlocking
- Lockable in 0-position
- High-temperature-resistant contact carrier
- Kontex contact and box terminals
- Nickel plated contacts
- Protection degree IP44
- Products with PILOT please add "P" to the ref.no.

Dimension drawing: see page 53/3 (12 MB 30)



2P+E Ampere	3P+E Poles	230V 50-60 Hz			400V 50-60 Hz			500V 50-60 Hz			Quantity	g
		3pol 6h	4pol 9h	5pol 9h	3pol 9h	4pol 6h	5pol 6h	3pol 7h	4pol 7h	5pol 7h		
63	5				16901					1	2245	

Technical Information

- IEC 60309, EN 60309, VDE 0623
- Particularly suitable for harsh operating conditions, especially resistant to aggressive atmospheres

Surface Mounting Socket Outlet

- Switched
- With mechanical double interlocking
- Lockable in 0-position
- High-temperature-resistant contact carrier
- Nickel plated contacts
- Protection degree IP67

Dimension drawing: see page 54/1 (12 MB 6)



16916

Amperage	Poles	230V 50-60 Hz			400V 50-60 Hz			500V 50-60 Hz			Quantity	Each
		3pol 6h	4pol 9h	5pol 9h	3pol 9h	4pol 6h	5pol 6h	3pol 7h	4pol 7h	5pol 7h		
16	5									9		
										1	690	

Surface Mounting Socket Outlet

- Switched
- With mechanical double interlocking
- Lockable in 0-position
- High-temperature-resistant contact carrier
- Nickel plated contacts
- Protection degree IP67

Dimension drawing: see page 54/2 (12 MB 11)



Amperage	Poles	230V 50-60 Hz			400V 50-60 Hz			500V 50-60 Hz			Quantity	Each
		3pol 6h	4pol 9h	5pol 9h	3pol 9h	4pol 6h	5pol 6h	3pol 7h	4pol 7h	5pol 7h		
16	5									9		
										1	1095	

Surface Mounting Socket Outlet

- Switched
- With mechanical double interlocking
- Lockable in 0-position
- High-temperature-resistant contact carrier
- Nickel plated contacts
- Protection degree IP67

Dimension drawing: see page 54/2 (12 MB 11)



Amperage	Poles	230V 50-60 Hz			400V 50-60 Hz			500V 50-60 Hz			Quantity	Each
		3pol 6h	4pol 9h	5pol 9h	3pol 9h	4pol 6h	5pol 6h	3pol 7h	4pol 7h	5pol 7h		
32	5									9		
										1	1400	

Surface Mounting Socket Outlet

- Switched
- With mechanical double interlocking
- Lockable in 0-position
- High-temperature-resistant contact carrier
- Kontex contact and box terminals
- Nickel plated contacts
- Protection degree IP67

Dimension drawing: see page 54/3 (12 MB 10)



Amperage	Poles	230V 50-60 Hz			400V 50-60 Hz			500V 50-60 Hz			Quantity	Each
		3pol 6h	4pol 9h	5pol 9h	3pol 9h	4pol 6h	5pol 6h	3pol 7h	4pol 7h	5pol 7h		
63	5									9		
										1	2315	

Surface Mounting Socket Outlet

- Switched
- With mechanical double interlocking
- Lockable in 0-position
- High-temperature-resistant contact carrier
- Kontex contact and box terminals
- Nickel plated contacts
- Protection degree IP67
- Products with PILOT please add "P" to the ref.no.

Dimension drawing: see page 55/1 (12 MB 5)



Amperage	Poles	230V 50-60 Hz			400V 50-60 Hz			500V 50-60 Hz			Quantity	Each
		3pol 6h	4pol 9h	5pol 9h	3pol 9h	4pol 6h	5pol 6h	3pol 7h	4pol 7h	5pol 7h		
125	5									9		
										1	4065	



Sockets

Surface Mounting Socket Outlets, switched, interlocked, fused

Technical Information

- IEC 60309, EN 60309, VDE 0623
- Particularly suitable for harsh operating conditions, especially resistant to aggressive atmospheres

Surface Mounting Socket Outlet

- Switched, interlocked
- Lockable in 0-position
- With Din rail
- 6 DU for 16A and 32A, 8 DU for 63A
- High-temperature-resistant contact carrier
- Nickel plated contacts
- 63A Box terminals
- Protection degree IP44
- Products with PILOT add "P" to the ref. no.



17566

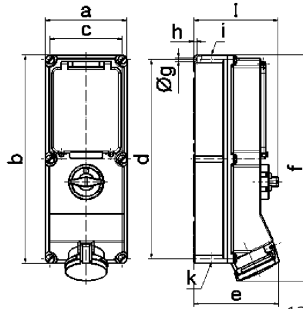

12 MB 21

Ampere Poles	16 5	32 5	63 5
a	134,0	134,0	180,0
b	365,0	365,0	460,0
c	117,0	117,0	160,0
d	348,0	348,0	440,0
e	141,0	152,0	184,0
f	382,0	391,0	500,0
ø g	6,5	6,5	8,3
h	8,0	8,0	6,5
i	M25/32	M32/40	M40
k	M25/32	M32/40	M32/40
l	156,0	156,0	189,0

Protection

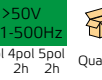
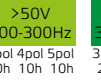
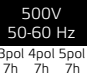
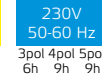

	16	5		Quantity	Each
			17608	1	
- without fuse protection	32	5	17612	1	
	63	5	17566	1	
- with fuse base D01 for 16A D02 for 32A and 63A	16	5	17615	1	
	32	5	17618	1	
	63	5	17569	1	3880
- with fuse base DII for 16A DIII for 32A and 63A	16	5	17622	1	
	32	5	17626	1	
	63	5	17573	1	
- with 3-pole C-type MCB	16	5	17629	1	
	32	5	17632	1	
	63	5	17576	1	
- with C-type MCB and RCCB 40/0,03A for 16A and 32A	16	5	17635	1	
	32	5	17638	1	
- with D02 and RCCB 63/0,03A for 63A	63	5	17579	1	

Technical Information

- IEC 60309, EN 60309, VDE 0623
- Particularly suitable for harsh operating conditions, especially resistant to aggressive atmospheres

Surface Mounting Socket Outlet

- Switched, interlocked
- Lockable in 0-position
- With Din rail
- 6 DU f. 16A and 32A, 8 DU f. 63A
- High-temperature-resistant contact carrier
- Nickel plated contacts
- 63A Box terminals
- Protection degree IP67
- Products with PILOT add "P" to the ref. no.

17583

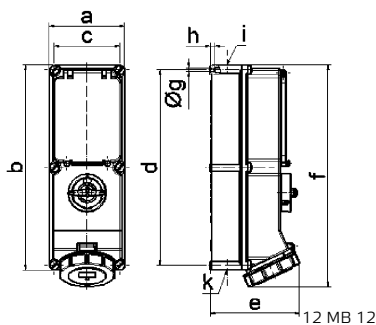

Ampere Poles	16 5	32 5	63 5
a	134,0	134,0	180,0
b	365,0	365,0	460,0
c	117,0	117,0	160,0
d	348,0	348,0	440,0
e	143,0	158,0	191,0
f	389,0	399,0	500,0
ø g	6,5	6,5	8,3
h	8,0	8,0	6,5
i	M25/32	M32/40	M40
k	M25/32	M32/40	M32/40

Protection

							>50V 100-300Hz symbol"/>	>50V 301-500Hz symbol"/>		9
Ampere	Poles		3pol 4pol 5pol 4h 4h 4h	3pol 4pol 5pol 6h 9h 9h	3pol 4pol 5pol 9h 6h 6h	3pol 4pol 5pol 7h 7h 7h	3pol 4pol 5pol 10h 10h 10h	3pol 4pol 5pol 2h 2h 2h	Quantity	Each

	16	5	17642	1	
- without fuse protection	32	5	17646	1	2060
	63	5	17583	1	3535
- with fuse base D01 for 16A D02 for 32A and 63A	16	5	17649	1	
	32	5	17652	1	
	63	5	17586	1	
- with fuse base DII for 16A DIII for 32A and 63A	16	5	17656	1	
	32	5	17660	1	
	63	5	17590	1	3985
- with 3-pole C-type MCB	16	5	17663	1	
	32	5	17666	1	
	63	5	17593	1	
- with C-type MCB and RCCB 40/0,03A for 16A and 32A	16	5	17669	1	
	32	5	17672	1	
- with D02 and RCCB 63/0,03A for 63A	63	5	17596	1	
- with load-break switch NH00	63	5	17604	1	4025

Panel Mounting Socket Outlet QUICK-CONNECT

- Screwless terminals
- Kontex contact
- Flange 75 x 75 mm
- Protection degree IP44

QUICK-CONNECT

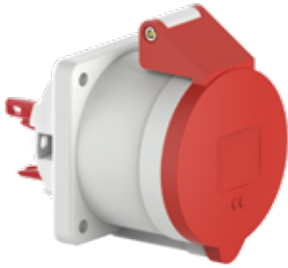

132002

Ampere	Poles	110V 50-60 Hz	230V 50-60 Hz	400V 50-60 Hz	500V 50-60 Hz	>50V 100-300Hz	>50V 301-500Hz	Quantity	Each
		3pol 4pol 5pol 4h 4h 4h	3pol 4pol 5pol 6h 9h 9h	3pol 4pol 5pol 9h 6h 6h	3pol 4pol 5pol 7h 7h 7h	3pol 4pol 5pol 10h 10h 10h	3pol 4pol 5pol 2h 2h 2h		
16	3	13685	13686	13687	13688	13689	13690	10	105
16	4	13691	13692	13693	13694	13695	13696	10	120
16	5	13697	13698	132001	13699	13700	13701	10	135
32	3	13702	13703	13704	13705	13706	13707	10	165
32	4	13708	13709	13710	13711	13712	13713	10	185
32	5	13714	13715	132002	13716	13717	13718	10	220

Ampere	Polzahl	16	16	16	32	32	32
Poles		3	4	5	3	4	5
a		75,0	75,0	75,0	75,0	75,0	75,0
b		75,0	75,0	75,0	75,0	75,0	75,0
c		60,0	60,0	60,0	60,0	60,0	60,0
d		60,0	60,0	60,0	60,0	60,0	60,0
ø e		5,5	5,5	5,5	5,5	5,5	5,5
f		7,0	7,0	7,0	8,0	8,0	8,0
h		35,5	35,5	35,5	50,0	50,0	50,0
i		50,0	50,0	51,0	60,0	60,0	60,0
k		74,0	84,0	91,0	94,0	94,0	102,0
ø l		45,0	45,0	55,0	60,0	60,0	60,0
m		3,5	7,0	11,5	12,0	12,0	17,0
Cond. mm² min		1,5	1,5	1,5	2,5	2,5	2,5
Cond. mm² max		4	4	4	10	10	10

4MB99

Panel Mounting Socket Outlet QUICK-CONNECT

- Screwless terminals
- Kontex contact
- Flange 75 x 75 mm
- Protection degree IP44

QUICK-CONNECT



132001

Ampere	Poles	110V 50-60 Hz	230V 50-60 Hz	400V 50-60 Hz	500V 50-60 Hz	>50V 100-300Hz	>50V 301-500Hz	Quantity	Each	
		3pol 4pol 5pol 4h 4h 4h	3pol 4pol 5pol 6h 9h 9h	3pol 4pol 5pol 9h 6h 6h	3pol 4pol 5pol 7h 7h 7h	3pol 4pol 5pol 10h 10h 10h	3pol 4pol 5pol 2h 2h 2h			
16	3	13851							10	105
16	4									
16	5								10	135
32	3									
32	4									
32	5								10	220

Ampere	Polzahl	16	16	16	32	32	32
Poles		3	4	5	3	4	5
a		75,0	75,0	75,0	75,0	75,0	75,0
b		75,0	75,0	75,0	75,0	75,0	75,0
c		60,0	60,0	60,0	60,0	60,0	60,0
d		60,0	60,0	60,0	60,0	60,0	60,0
ø e		5,5	5,5	5,5	5,5	5,5	5,5
f		7,0	7,0	7,0	8,0	8,0	8,0
h		35,5	35,5	35,5	50,0	50,0	50,0
i		52,0	53,0	57,0	65,0	65,0	66,0
ø l		45,0	45,0	55,0	60,0	60,0	60,0
m		3,5	7,0	11,5	12,0	12,0	17,0
x		71,5	80,0	86,0	91,0	91,0	99,0
y		75,0	75,0	75,0	75,0	75,0	75,0
z		88,0	89,0	93,0	115,0	115,0	116,0
Cond. mm² min		1,5	1,5	1,5	2,5	2,5	2,5
Cond. mm² max		4,0	4,0	4,0	10,0	10,0	10,0

4MB103

Panel Mounting Socket Outlet QUICK-CONNECT

- Screwless terminals
- Kontex contact
- Flange 56 x 56 mm for 16A 3p,
60 x 60 mm for 16A 4p
- Protection degree IP44

QUICK-CONNECT



13663

Ampere	Poles	110V 50-60 Hz	230V 50-60 Hz	400V 50-60 Hz	500V 50-60 Hz	>50V 100-300Hz	>50V 301-500Hz	Quantity	Each
		3pol 4pol 5pol 4h 4h 4h	3pol 4pol 5pol 6h 9h 9h	3pol 4pol 5pol 9h 6h 6h	3pol 4pol 5pol 7h 7h 7h	3pol 4pol 5pol 10h 10h 10h	3pol 4pol 5pol 2h 2h 2h		
16	3	13656	13646	13657	13658	13659	13660	10	90
16	4	13661	13662	13663	13664	13665	13666	10	110

Ampere	Polzahl	16	16
Poles		3	4
a		56,0	60,0
b		56,0	60,0
c		44,0	50-52
d		44,0	50-52
ø e		5,5	5,5
f		7,0	7,0
h		35,5	35,5
i		51,0	53,0
k		70,0	80,0
ø l		45,0	45,0
m		13,0	9,0
Cond. mm² min		1,5	1,5
Cond. mm² max		4	4

4 MB 101

Technical Information

- IEC 60309-1/2, EN 60309, VDE 0623

Panel Mounting Socket Outlet QUICK-CONNECT

- Screwless terminals
- Kontex contact
- Flange 62 x 62 mm for 16A 3p, 72 x 65 mm for 16A 4p and 5p
- Protection degree IP44

QUICK-CONNECT



13681

Amperage	Poles	110V	230V	400V	500V	>50V	>50V	Quantity	Each
		50-60 Hz	50-60 Hz	50-60 Hz	50-60 Hz	100-300Hz	301-500Hz		
16	3	13667	13668	13669	13670	13671	13672	10	95
16	4	13673	13674	13675	13676	13677	13678	10	120
16	5	13679	13680	13681	13682	13683	13684	10	130

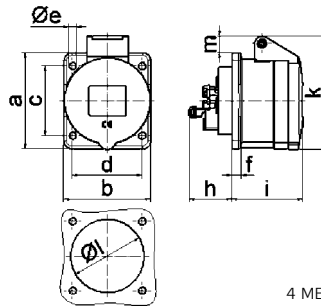

Amperage	Poles	16	16	16
a	3	62,0	72,0	72,0
b	4	62,0	65,0	65,0
c	5	47,0	52,0	52,0
d	3	47,0	52,0	52,0
ø e	3	5,5	5,5	5,5
f	3	7,0	7,0	7,0
h	3	35,5	35,5	35,5
i	3	51,0	53,0	53,0
k	3	70,0	80,0	85,0
ø l	3	45,0	45,0	55,0
m	3	13,0	9,0	13,0
Cond. mm² min		1,5	1,5	1,5
Cond. mm² max		4	4	4

4 MB 100

Panel Mounting Socket Outlet QUICK-CONNECT

- Screwless terminals
- Kontex contact
- Flange 70 x 70 mm
- Protection degree IP44

QUICK-CONNECT



13895

Amperage	Poles	110V	230V	400V	500V	>50V	>50V	Quantity	Each
		50-60 Hz	50-60 Hz	50-60 Hz	50-60 Hz	100-300Hz	301-500Hz		
16	5			13895				10	120
32	5			13896				10	220

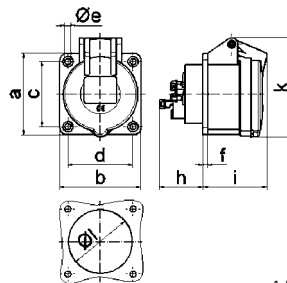

Amperage	Poles	16	32
a	5	70,0	70,0
b	5	70,0	70,0
c	5	56,0	56,0
d	5	56,0	56,0
ø e	5	5,5	5,5
f	5	4,0	4,0
h	5	35,5	46,0
i	5	57,0	66,0
k	5	86,0	99,0
ø l	5	55,0	60,0
Cond. mm² min		1,5	2,5
Cond. mm² max		4	10

4 MB 166

Panel Mounting Socket Outlet

- Screw terminals
- Flange 107 x 100 mm
- Kontex contact
- Nickel plated contacts
- Box terminals
- Protection degree IP44
- Products with PILOT please add "P" to the ref.no.

136



Amperage	Poles	110V	230V	400V	500V	>50V	>50V	Quantity	Each
		50-60 Hz	50-60 Hz	50-60 Hz	50-60 Hz	100-300Hz	301-500Hz		
63	3	1306	1307	1308	13592	13254		5	415
63	4	1309	1304	134	1301	13320	13077	5	445
63	5	13140	1305	136	13168	13321	13051	5	490

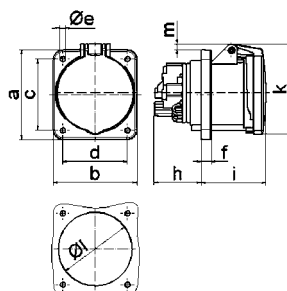

Amperage	Poles	63	63	63
a	3	107,0	107,0	107,0
b	4	100,0	100,0	100,0
c	5	85,0	85,0	85,0
d	3	77,0	77,0	77,0
ø e	3	6,5	6,5	6,5
f	3	12,0	12,0	12,0
h	3	56,5	56,5	56,5
i	3	77,0	77,0	77,0
k	3	110,0	110,0	110,0
ø l	3	88,0	88,0	88,0
m	3	7,0	7,0	7,0
Cond. mm² min		6	6	6
Cond. mm² max		25	25	25

4 MB 8

Panel Mounting Socket Outlet QUICK-CONNECT

- Screwless terminals
- Flange 107 x 100 mm
- High-temperature-resistant contact carrier
- Kontex contact
- Nickel plated contacts
- Box terminals
- Protection degree IP44

QUICK-CONNECT



130114

Ampere	Poles	110V 50-60 Hz			230V 50-60 Hz			400V 50-60 Hz			>50V 100-300Hz			>50V 301-500Hz			Quantity	Each
		3pol	4pol	5pol	3pol	4pol	5pol	3pol	4pol	5pol	3pol	4pol	5pol	3pol	4pol	5pol		
63	4																5	550
63	5																5	600

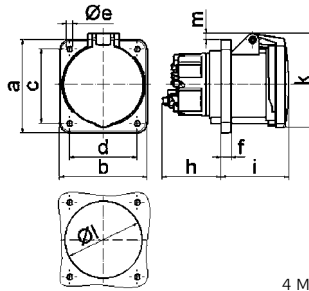

Ampere	Poles	63	63
a	107,0	107,0	
b	100,0	100,0	
c	85,0	85,0	
d	77,0	77,0	
Øe	6,5	6,5	
f	12,0	12,0	
h	67,0	67,0	
i	77,0	77,0	
k	110,0	110,0	
Øl	88,0	88,0	
m	7,0	7,0	
Cond. mm ² min		6	6
Cond. mm ² max		25	25

4 MB 265

Panel Mounting Socket Outlet QUICK-CONNECT

- Screwless terminals
- 20° angled
- Kontex contact
- Flange 68 x 62 mm for 16A 3p, 87 x 71 mm for 16A 4p and 5p
- Protection degree IP44

QUICK-CONNECT



12741

Ampere	Poles	110V 50-60 Hz			230V 50-60 Hz			400V 50-60 Hz			>50V 100-300Hz			>50V 301-500Hz			Quantity	Each
		3pol	4pol	5pol	3pol	4pol	5pol	3pol	4pol	5pol	3pol	4pol	5pol	3pol	4pol	5pol		
16	3																10	95
16	4																10	120
16	5																10	140

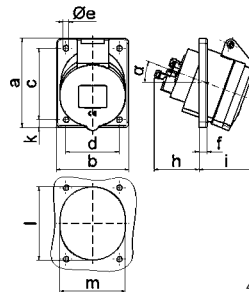

Ampere	Poles	16	16	16
a	68,0	87,0	87,0	
b	62,0	71,0	71,0	
c	47,0	70,0	70,0	
d	47,0	52,0	52,0	
Øe	5,5	5,5	5,5	
f	8,0	5,5	5,5	
h	46,0	46,0	46,0	
i	50,0	54,0	54,0	
k	-	9,5	9,5	
l	56,0	65,0	72,0	
m	51,0	58,0	64,0	
α	20°	20°	20°	
Cond. mm ² min		1,5	1,5	1,5
Cond. mm ² max		4	4	4

4 MB 111

Panel Mounting Socket Outlet QUICK-CONNECT

- Screwless terminals
- 20° angled
- Kontex contact
- Flange 75 x 75 mm
- Protection degree IP44

QUICK-CONNECT



122001

Ampere	Poles	110V 50-60 Hz			230V 50-60 Hz			400V 50-60 Hz			>50V 100-300Hz			>50V 301-500Hz			Quantity	Each
		3pol	4pol	5pol	3pol	4pol	5pol	3pol	4pol	5pol	3pol	4pol	5pol	3pol	4pol	5pol		
16	5																10	135

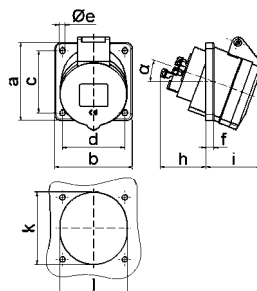

Ampere	Poles	16
a	75,0	75,0
b	75,0	75,0
c	60,0	60,0
d	60,0	60,0
Øe	5,5	5,5
f	8,0	8,0
h	46,0	46,0
i	54,0	54,0
k	70,0	70,0
l	65,0	65,0
α	20°	20°
Cond. mm ² min		1,5
Cond. mm ² max		4

4 MB 110

Technical Information

- IEC 60309-1/2, EN 60309, VDE 0623

Panel Mounting Socket Outlet QUICK-CONNECT

- Screwless terminals
- 20° angled
- Kontex contact
- Flange 85 x 85 mm
- Protection degree IP44

QUICK-CONNECT



12757

Ampere	Poles	110V 50-60 Hz	230V 50-60 Hz	400V 50-60 Hz	500V 50-60 Hz	>50V 100-300Hz	>50V 301-500Hz	Quantity	Each
		3pol 4pol 5pol 4h 4h 4h	3pol 4pol 5pol 6h 9h 9h	3pol 4pol 5pol 9h 6h 6h	3pol 4pol 5pol 7h 7h 7h	3pol 4pol 5pol 10h 10h 10h	3pol 4pol 5pol 2h 2h 2h		
16	3	12748	12749	12750	12751	12861	12752	10	120
16	4	12862	12863	12753	12864	12754	12865	10	135
16	5	12755	12756	12757	12758	12866	12759	10	145
32	3	12760	12761	12867	12762	12868	12869	10	180
32	4	12870	12763	12764	12765	12871	12872	10	200
32	5	12766	12767	12768	12769	12770	12873	10	235

Ampere	Poles	a	b	c	d	ø e	f	h	i	ø l	α	Cond. mm² min	Cond. mm² max
16	3	85,0	85,0	70,0	70,0	5,5	8,0	46,0	50,0	57,0	20°	1,5	4
16	4	85,0	85,0	70,0	70,0	5,5	8,0	46,0	51,0	65,0	20°	1,5	4
16	5	85,0	85,0	70,0	70,0	5,5	8,0	46,0	54,0	70,0	20°	1,5	4
32	3	85,0	85,0	70,0	70,0	5,5	8,0	55,0	60,0	78,0	20°	2,5	10
32	4	85,0	85,0	70,0	70,0	5,5	8,0	55,0	60,0	78,0	20°	2,5	10
32	5	85,0	85,0	70,0	70,0	5,5	8,0	55,0	60,0	78,0	20°	2,5	10

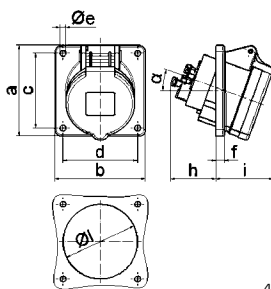

4 MB 264

Panel Mounting Socket Outlet QUICK-CONNECT

- Screwless terminals
- 20° angled
- Kontex contact
- Flange 74 x 62 mm for 16A 3p,
100 x 92 mm for the other versions
- Protection degree IP44



12730

Ampere	Poles	110V 50-60 Hz	230V 50-60 Hz	400V 50-60 Hz	500V 50-60 Hz	>50V 100-300Hz	>50V 301-500Hz	Quantity	Each
		3pol 4pol 5pol 4h 4h 4h	3pol 4pol 5pol 6h 9h 9h	3pol 4pol 5pol 9h 6h 6h	3pol 4pol 5pol 7h 7h 7h	3pol 4pol 5pol 10h 10h 10h	3pol 4pol 5pol 2h 2h 2h		
16	3	12771	12772	12773	12774	12775	12776	10	100
16	4	12777	12778	12779	12780	12781	12782	10	140
16	5	12783	12784	12730	12785	12786	12787	10	160
32	3	12788	12789	12790	12874	12791	12792	10	200
32	4	12793	12794	12795	12796	12797	12798	10	210
32	5	12799	12800	12801	12802	12803	12804	10	240

Ampere	Poles	a	b	c	d	ø e	f	h	i	k	l	α	Cond. mm² min	Cond. mm² max
16	3	74,0	62,0	60,0	52,0	5,5	8,0	46,0	48,0	57,0	52,0	20°	1,5	4
16	4	100,0	92,0	85,0	77,0	5,5	8,0	46,0	50,0	65,0	65,0	20°	1,5	4
16	5	100,0	92,0	85,0	77,0	5,5	8,0	46,0	55,0	70,0	70,0	20°	1,5	4
32	3	100,0	92,0	85,0	77,0	5,5	8,0	55,0	68,0	75,0	75,0	20°	2,5	10
32	4	100,0	92,0	85,0	77,0	5,5	8,0	55,0	68,0	75,0	75,0	20°	2,5	10
32	5	100,0	92,0	85,0	77,0	5,5	8,0	55,0	68,0	75,0	75,0	20°	2,5	10

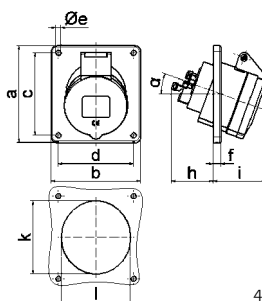

4 MB 112

Panel Mounting Socket Outlet QUICK-CONNECT

- Screwless terminals
- 20° angled
- Kontex contact
- Flange 110 x 110 mm
- Protection degree IP44



12805

Ampere	Poles	110V 50-60 Hz	230V 50-60 Hz	400V 50-60 Hz	500V 50-60 Hz	>50V 100-300Hz	>50V 301-500Hz	Quantity	Each
		3pol 4pol 5pol 4h 4h 4h	3pol 4pol 5pol 6h 9h 9h	3pol 4pol 5pol 9h 6h 6h	3pol 4pol 5pol 7h 7h 7h	3pol 4pol 5pol 10h 10h 10h	3pol 4pol 5pol 2h 2h 2h		
16	5				12805			10	185
32	5				12806			10	260

Ampere	Poles	a	b	c	d	ø e	f	h	i	ø l	α	Cond. mm² min	Cond. mm² max
16	5	110,0	110,0	90,0	90,0	5,5	8,0	46,0	56,0	75,0	20°	1,5	4
32	5	110,0	110,0	90,0	90,0	5,5	8,0	55,0	60,0	78,0	20°	2,5	10

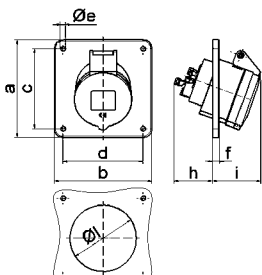

4 MB 269

Panel Mounting Socket Outlet

- Screw terminals
- 15° angled
- Flange 100 x 92 mm
- Kontex contact
- Box terminals
- Nickel plated contacts
- Protection degree IP44
- Products with PILOT please add "P" to the ref.no.



12567

Ampere	Poles	110V	230V	400V	500V	>50V	>50V	Quantity	Each
		50-60 Hz	50-60 Hz	50-60 Hz	50-60 Hz	100-300Hz	301-500Hz		
63	3		12563					10	415
63	4			12074	12565			10	430
63	5	12566	12568	12567				10	475

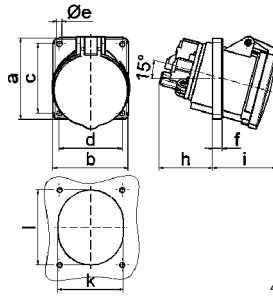

Ampere Poles	63 3	63 4	63 5
a	100,0	100,0	100,0
b	92,0	92,0	92,0
c	85,0	85,0	85,0
d	77,0	77,0	77,0
ø e	6,5	6,5	6,5
f	12,0	12,0	12,0
h	65,0	65,0	65,0
i	81,0	81,0	81,0
k	80,0	80,0	80,0
l	92,0	92,0	92,0
Cond. mm² min	6	6	6
Cond. mm² max	25	25	25

4 MB 64

Panel Mounting Socket Outlet

- Screw terminals
- 15° angled
- Flange 114 x 114 mm
- Kontex contact
- Box terminals
- Nickel plated contacts
- Protection degree IP44
- Products with PILOT please add "P" to the ref.no.



1202

Ampere	Poles	110V	230V	400V	500V	>50V	>50V	Quantity	Each
		50-60 Hz	50-60 Hz	50-60 Hz	50-60 Hz	100-300Hz	301-500Hz		
63	3	12134	12135	12136		12381	12230	5	420
63	4	12137	1207	1201	1204	12382	12153	5	460
63	5	12138	1208	1202	12195	12383		5	500

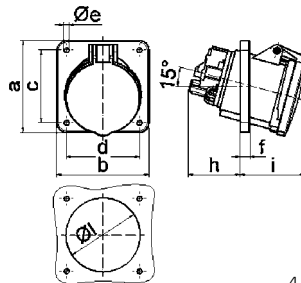

Ampere Poles	63 3	63 4	63 5
a	114,0	114,0	114,0
b	114,0	114,0	114,0
c	90,0	90,0	90,0
d	90,0	90,0	90,0
ø e	6,5	6,5	6,5
f	12,0	12,0	12,0
h	65,0	65,0	65,0
i	81,0	81,0	81,0
ø l	92,0	92,0	92,0
Cond. mm² min	6	6	6
Cond. mm² max	25	25	25

4 MB 10

Panel Mounting Socket Outlet QUICK-CONNECT

- Screwless terminals
- 15° angled
- Flange 114 x 114 mm
- High-temperature-resistant contact carrier
- Kontex contact
- Nickel plated contacts
- Box terminals
- Protection degree IP44



120306

Ampere	Poles	110V	230V	400V	500V	>50V	>50V	Quantity	Each
		50-60 Hz	50-60 Hz	50-60 Hz	50-60 Hz	100-300Hz	301-500Hz		
63	4			120321	120431			5	570
63	5			120306				5	620

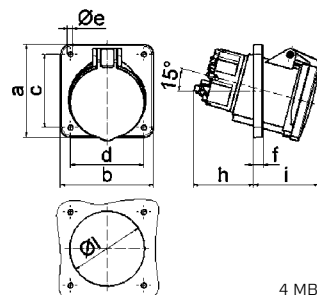

Ampere Poles	63 4	63 5
a	114,0	114,0
b	114,0	114,0
c	90,0	90,0
d	90,0	90,0
ø e	6,5	6,5
f	12,0	12,0
h	74,0	74,0
i	81,0	81,0
ø l	92,0	92,0
Cond. mm² min	6	6
Cond. mm² max	25	25

4 MB 266

Technical Information

- IEC 60309-1/2, EN 60309, VDE 0623

Panel Mounting Socket Outlet QUICK-CONNECT

- Screwless terminals
- Kontex contact
- Flange 62 x 62 mm for 16A 3p, 72 x 65 mm for 16A 4p and 5p
- Protection degree IP67

QUICK-CONNECT



13732

Amperage	Poles	110V 50-60 Hz	230V 50-60 Hz	400V 50-60 Hz	500V 50-60 Hz	>50V 100-300Hz	>50V 301-500Hz	Quantity	Each
		3pol 4pol 5pol 4h 4h 4h	3pol 4pol 5pol 6h 9h 9h	3pol 4pol 5pol 9h 6h 6h	3pol 4pol 5pol 7h 7h 7h	3pol 4pol 5pol 10h 10h 10h	3pol 4pol 5pol 2h 2h 2h		
16	3	13719	13720	13721				10	120
16	4	13724	13725	13726	13727			10	150
16	5	13730	13731	13732				10	170

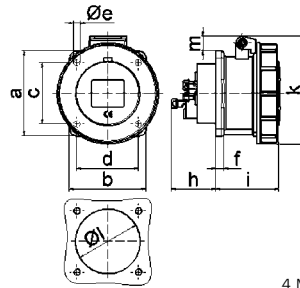

Amperage	Poles	16	16	16
a	3	62,0	72,0	72,0
b	4	62,0	65,0	65,0
c	5	47,0	52,0	52,0
d		47,0	52,0	52,0
Øe		5,5	5,5	5,5
f		7,0	7,0	7,0
h		35,5	35,5	35,5
i		57,0	58,0	57,0
k		76,0	83,0	93,0
Øl		45,0	45,0	55,0
m		10,0	9,0	13,0
Cond. mm² min		1,5	1,5	1,5
Cond. mm² max		4	4	4

4 MB 104

Panel Mounting Socket Outlet QUICK-CONNECT

- Screwless terminals
- Kontex contact
- Flange 75 x 75 mm
- Protection degree IP67

QUICK-CONNECT



13745

Amperage	Poles	110V 50-60 Hz	230V 50-60 Hz	400V 50-60 Hz	500V 50-60 Hz	>50V 100-300Hz	>50V 301-500Hz	Quantity	Each
		3pol 4pol 5pol 4h 4h 4h	3pol 4pol 5pol 6h 9h 9h	3pol 4pol 5pol 9h 6h 6h	3pol 4pol 5pol 7h 7h 7h	3pol 4pol 5pol 10h 10h 10h	3pol 4pol 5pol 2h 2h 2h		
16	3	13733	13734	13735		13736		10	130
16	4	13737	13738	13739	13740	13741	13742	10	145
16	5	13743	13744	13745	13746	13747	13748	10	160
32	3	13749	13750	13751		13752	13753	10	210
32	4	13754	13755	13756	13757	13758	13759	10	225
32	5	13760	13761	13762	13763	13764	13765	10	265

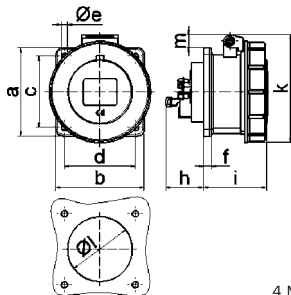

Amperage	Poles	16	16	16	32	32	32
a	3	75,0	75,0	75,0	75,0	75,0	75,0
b	4	75,0	75,0	75,0	75,0	75,0	75,0
c	5	60,0	60,0	60,0	60,0	60,0	60,0
d		60,0	60,0	60,0	60,0	60,0	60,0
Øe		5,5	5,5	5,5	5,5	5,5	5,5
f		7,0	7,0	7,0	8,0	8,0	8,0
h		35,5	35,5	35,5	46,0	46,0	46,0
i		57,0	58,0	57,0	65,0	65,0	65,0
k		76,0	83,0	93,0	100,0	100,0	106,0
Øl		45,0	45,0	55,0	60,0	60,0	60,0
m		3,5	7,0	11,5	12,0	12,0	17,0
Cond. mm² min		1,5	1,5	1,5	2,5	2,5	2,5
Cond. mm² max		4	4	4	10	10	10

4 MB 105

Panel Mounting Socket Outlet QUICK-CONNECT

- Screwless twin terminal
- Kontex contact
- Flange 75 x 75 mm
- Protection degree IP67

QUICK-CONNECT



130158

Amperage	Poles	110V 50-60 Hz	230V 50-60 Hz	400V 50-60 Hz	500V 50-60 Hz	>50V 100-300Hz	>50V 301-500Hz	Quantity	Each
		3pol 4pol 5pol 4h 4h 4h	3pol 4pol 5pol 6h 9h 9h	3pol 4pol 5pol 9h 6h 6h	3pol 4pol 5pol 7h 7h 7h	3pol 4pol 5pol 10h 10h 10h	3pol 4pol 5pol 2h 2h 2h		
16	5			130158				10	205

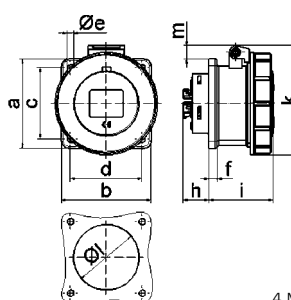

Amperage	Poles	16
a	5	75,0
b		75,0
c		60,0
d		60,0
Øe		5,5
f		7,0
h		23,0
i		57,0
k		93,0
Øl		55,0
m		11,5
Cond. mm² min		1,5
Cond. mm² max		4

4 MB 262

Panel Mounting Socket Outlet

- Screw terminals
- Flange 107 x 100 mm
- Kontex contact
- Nickel plated contacts
- Box terminals
- Protection degree IP67
- Products with PILOT please add "P" to the ref.no.



13104

Ampere	Poles	110V	230V	400V	500V	>50V	>50V	Quantity	Each
		50-60 Hz	50-60 Hz	50-60 Hz	50-60 Hz	100-300Hz	301-500Hz		
63	3	1395	1396	1397				5	460
63	4	1398	1399	13100	13101			5	490
63	5	13102	13103	13104				5	535

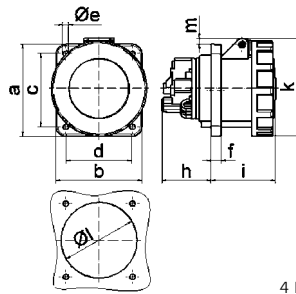

Ampere Poles	63 3	63 4	63 5
a	107,0	107,0	107,0
b	100,0	100,0	100,0
c	85,0	85,0	85,0
d	77,0	77,0	77,0
Øe	6,5	6,5	6,5
f	12,0	12,0	12,0
h	56,5	56,5	56,5
i	76,0	76,0	76,0
k	113,0	113,0	113,0
Øl	88,0	88,0	88,0
m	7,0	7,0	7,0
Cond. mm² min	6	6	6
Cond. mm² max	25	25	25

4 MB 50

Panel Mounting Socket Outlet QUICK-CONNECT

- Screwless terminals
- Flange 107 x 100 mm
- High-temperature-resistant contact carrier
- Kontex contact
- Nickel plated contacts
- Box terminals
- Protection degree IP67



130119

Ampere	Poles	110V	230V	400V	500V	>50V	>50V	Quantity	Each
		50-60 Hz	50-60 Hz	50-60 Hz	50-60 Hz	100-300Hz	301-500Hz		
63	4			130131	130154			5	565
63	5			130119				5	665

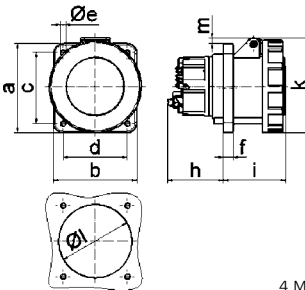

Ampere Poles	63 4	63 5
a	107,0	107,0
b	100,0	100,0
c	85,0	85,0
d	77,0	77,0
Øe	6,5	6,5
f	12,0	12,0
h	67,0	67,0
i	76,0	76,0
k	113,0	113,0
Øl	88,0	88,0
m	7,0	7,0
Cond. mm² min	6	6
Cond. mm² max	25	25

4 MB 267

Panel Mounting Socket Outlet

- Screw terminals
- Flange 120 x 120 mm
- High-temperature-resistant contact carrier
- Kontex contact
- Nickel plated contacts
- Box terminals
- Protection degree IP67
- Products with PILOT please add "P" to the ref.no.



13451

Ampere	Poles	110V	230V	400V	500V	>50V	>50V	Quantity	Each
		50-60 Hz	50-60 Hz	50-60 Hz	50-60 Hz	100-300Hz	301-500Hz		
125	3	13445	13452					5	930
125	4		13449	13447	13448			5	1005
125	5			13451				5	1125

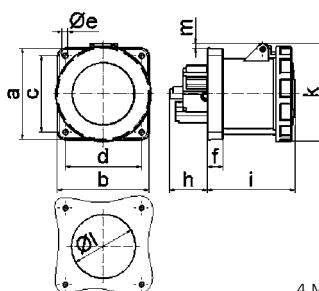

Ampere Poles	125 3	125 4	125 5
a	120,0	120,0	120,0
b	120,0	120,0	120,0
c	100,0	100,0	100,0
d	100,0	100,0	100,0
Øe	6,5	6,5	6,5
f	21,0	21,0	21,0
h	50,0	50,0	50,0
i	117,0	117,0	117,0
k	129,0	129,0	129,0
Øl	104,0	104,0	104,0
m	6,0	6,0	6,0
Cond. mm² min	25	25	25
Cond. mm² max	70	70	70

4 MB 55

Panel Mounting Socket Outlet

- Screw terminals
- Flange 130 x 130 mm
- High-temperature-resistant contact carrier
- Kontex contact
- Nickel plated contacts
- Box terminals
- Protection degree IP67
- Products with PILOT please add "P" to the ref.no.

Amperage	Poles	110V	230V	400V	500V	>50V	>50V	Quantity	Each
		50-60 Hz	50-60 Hz	50-60 Hz	50-60 Hz	100-300Hz	301-500Hz		
125	3		13434					5	965
125	4		13442	13435	13515			5	1040
125	5			13436				5	1140



13436

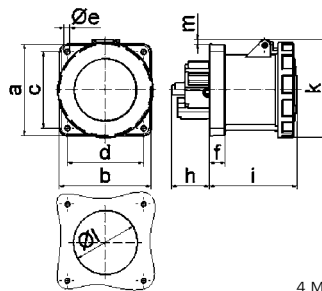

Amperage	125	125	125
Poles	3	4	5
a	130,0	130,0	130,0
b	130,0	130,0	130,0
c	104,0	104,0	104,0
d	104,0	104,0	104,0
ø e	6,5	6,5	6,5
f	21,0	21,0	21,0
h	50,0	50,0	50,0
i	117,0	117,0	117,0
k	129,0	129,0	129,0
ø l	104,0	104,0	104,0
m	1,0	1,0	1,0
Cond. mm² min	25	25	25
Cond. mm² max	70	70	70

4 MB 55

Panel Mounting Socket Outlet QUICK-CONNECT

- Screwless terminals
- 20° angled
- Kontex contact
- Flange 68 x 62 mm for 16A 3p, 75 x 75 mm for 16A 5p
- Protection degree IP67

Amperage	Poles	110V	230V	400V	500V	>50V	>50V	Quantity	Each
		50-60 Hz	50-60 Hz	50-60 Hz	50-60 Hz	100-300Hz	301-500Hz		
16	3	12808	12809					10	125
16	5	12810	12811	12812				10	



12812

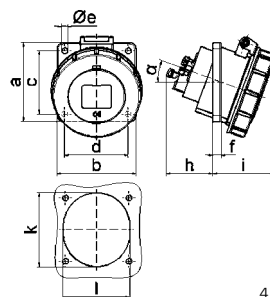

Amperage	16	16
Poles	3	5
a	68,0	75,0
b	62,0	75,0
c	47,0	60,0
d	47,0	60,0
ø e	5,5	5,5
f	8,0	5,5
h	46,0	46,0
i	57,0	60,0
k	56,0	70,0
l	51,0	63,0
α	20°	20°
Cond. mm² min	1,5	1,5
Cond. mm² max	4	4

4 MB 113

Panel Mounting Socket Outlet QUICK-CONNECT

- Screwless terminals
- 20° angled
- Kontex contact
- Flange 85 x 85 mm
- Protection degree IP67

Amperage	Poles	110V	230V	400V	500V	>50V	>50V	Quantity	Each
		50-60 Hz	50-60 Hz	50-60 Hz	50-60 Hz	100-300Hz	301-500Hz		
16	3	12917	12813					10	150
16	4		12929	12814	12930			10	170
16	5	12815	12816	12817				10	200
32	3	12818	12819					10	230
32	4		12820	12821	12931			10	255
32	5	12822	12823	12824				10	310



12817

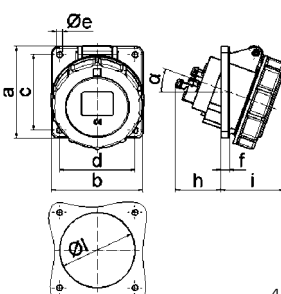

Amperage	16	16	16	32	32	32
Poles	3	4	5	3	4	5
a	85,0	85,0	85,0	85,0	85,0	85,0
b	85,0	85,0	85,0	85,0	85,0	85,0
c	70,0	70,0	70,0	70,0	70,0	70,0
d	70,0	70,0	70,0	70,0	70,0	70,0
ø e	5,5	5,5	5,5	5,5	5,5	5,5
f	8,0	8,0	8,0	8,0	8,0	8,0
h	46,0	46,0	46,0	55,0	55,0	55,0
i	57,0	57,0	60,0	65,0	65,0	69,0
ø l	57,0	65,0	70,0	78,0	78,0	78,0
α	20°	20°	20°	20°	20°	20°
Cond. mm² min	1,5	1,5	1,5	2,5	2,5	2,5
Cond. mm² max	4	4	4	10	10	10

4 MB 114

Panel Mounting Socket Outlet QUICK-CONNECT

- Screwless terminals
- 20° angled
- Kontex contact
- Flange 74 x 62 mm for 16A 3p, 100 x 92 mm for the other versions
- Protection degree IP67

QUICK-CONNECT



12839

Ampere	Poles	110V 50-60 Hz	230V 50-60 Hz	400V 50-60 Hz	500V 50-60 Hz	>50V 100-300Hz	>50V 301-500Hz	Quantity	Each
		3pol 4pol 5pol 4h 4h 4h	3pol 4pol 5pol 6h 9h 9h	3pol 4pol 5pol 9h 6h 6h	3pol 4pol 5pol 7h 7h 7h	3pol 4pol 5pol 10h 10h 10h	3pol 4pol 5pol 2h 2h 2h		
16	3	12825	12826					10	125
16	4	12831	12832	12833	12834	12835	12836	10	175
16	5	12837	12838	12839	12840	12841	12842	10	195
32	3	12843	12844					10	215
32	4	12846	12847	12848	12849	12850	12851	10	240
32	5	12852	12853	12854	12855	12856	12857	10	285

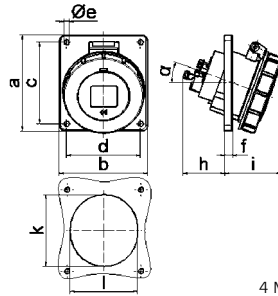

4 MB 115

Ampere Poles	16 3	16 4	16 5	32 3	32 4	32 5
a	74,0	100,0	100,0	100,0	100,0	100,0
b	62,0	92,0	92,0	92,0	92,0	92,0
c	60,0	85,0	85,0	85,0	85,0	85,0
d	52,0	77,0	77,0	77,0	77,0	77,0
ø e	5,5	5,5	5,5	5,5	5,5	5,5
f	8,0	8,0	8,0	8,0	8,0	8,0
h	46,0	46,0	46,0	55,0	55,0	55,0
i	57,0	57,0	60,0	65,0	65,0	69,0
k	57,0	65,0	70,0	75,0	75,0	78,0
l	52,0	65,0	70,0	75,0	75,0	78,0
α	20°	20°	20°	20°	20°	20°
Cond. mm² min	1,5	1,5	1,5	2,5	2,5	2,5
Cond. mm² max	4	4	4	10	10	10

Panel Mounting Socket Outlet

- Screw terminals
- 15° angled
- Flange 100 x 92 mm
- Kontex contact
- Nickel plated contacts
- Box terminals
- Protection degree IP67
- Products with PILOT please add "P" to the ref.no.



12574

Ampere	Poles	110V 50-60 Hz	230V 50-60 Hz	400V 50-60 Hz	500V 50-60 Hz	>50V 100-300Hz	>50V 301-500Hz	Quantity	Each
		3pol 4pol 5pol 4h 4h 4h	3pol 4pol 5pol 6h 9h 9h	3pol 4pol 5pol 9h 6h 6h	3pol 4pol 5pol 7h 7h 7h	3pol 4pol 5pol 10h 10h 10h	3pol 4pol 5pol 2h 2h 2h		
63	3		12569					10	445
63	4		12032	12570	12571			10	480
63	5	12572	12573	12574				10	525

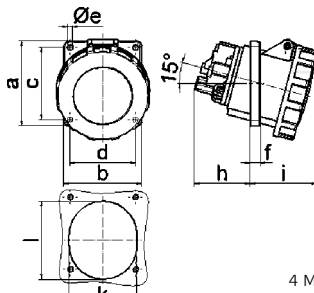

4 MB 65

Ampere Poles	63 3	63 4	63 5
a	100,0	100,0	100,0
b	92,0	92,0	92,0
c	85,0	85,0	85,0
d	77,0	77,0	77,0
ø e	6,5	6,5	6,5
f	12,0	12,0	12,0
h	65,0	65,0	65,0
i	80,0	80,0	80,0
k	80,0	80,0	80,0
l	92,0	92,0	92,0
Cond. mm² min	6	6	6
Cond. mm² max	25	25	25

Panel Mounting Socket Outlet QUICK-CONNECT TE

- Screwless terminals
- 15° angled
- Flange 100 x 92 mm
- High-temperature-resistant contact carrier
- Kontex contact
- Nickel plated contacts
- Box terminals
- Protection degree IP67



120274

Ampere	Poles	110V 50-60 Hz	230V 50-60 Hz	400V 50-60 Hz	500V 50-60 Hz	>50V 100-300Hz	>50V 301-500Hz	Quantity	Each
		3pol 4pol 5pol 4h 4h 4h	3pol 4pol 5pol 6h 9h 9h	3pol 4pol 5pol 9h 6h 6h	3pol 4pol 5pol 7h 7h 7h	3pol 4pol 5pol 10h 10h 10h	3pol 4pol 5pol 2h 2h 2h		
63	4			120320	120342			10	630
63	5			120274				10	645

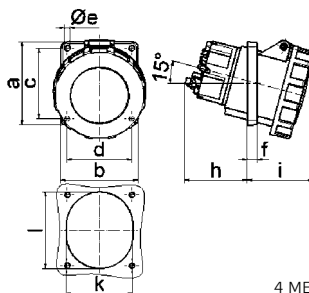

4 MB 268

Ampere Poles	63 4	63 5
a	100,0	100,0
b	92,0	92,0
c	85,0	85,0
d	77,0	77,0
ø e	6,5	6,5
f	12,0	12,0
h	74,0	74,0
i	80,0	80,0
k	80,0	80,0
l	92,0	92,0
Cond. mm² min	6	6
Cond. mm² max	25	25

Panel Mounting Socket Outlet

- Screw terminals
- 15° angled
- Flange 114 x 114 mm
- Kontex contact
- Nickel plated contacts
- Box terminals
- Protection degree IP67
- Products with PILOT please add "P" to the ref.no.



129

Ampere	Poles	110V	230V	400V	500V	>50V	>50V	Quantity	Each
		50-60 Hz	50-60 Hz	50-60 Hz	50-60 Hz	100-300Hz	301-500Hz		
63	3	12000	12001	12002				5	475
63	4	12003	1205	1200	1203	12035	12233	5	510
63	5	12004	1206	129	12039	12389	12171	5	550

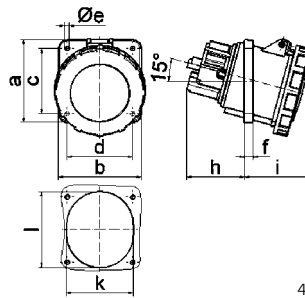

4 MB 9

Ampere	63	63	63
Poles	3	4	5
a	114,0	114,0	114,0
b	114,0	114,0	114,0
c	90,0	90,0	90,0
d	90,0	90,0	90,0
ø e	6,5	6,5	6,5
f	12,0	12,0	12,0
h	65,0	65,0	65,0
i	80,0	80,0	80,0
k	92,0	92,0	92,0
l	92,0	92,0	92,0
Cond. mm² min	6	6	6
Cond. mm² max	25	25	25

Panel Mounting Socket Outlet QUICK-CONNECT TE

- Screwless terminals
- 15° angled
- Flange 114 x 114 mm
- High-temperature-resistant contact carrier
- Kontex contact
- Nickel plated contacts
- Box terminals
- Protection degree IP67



120307

Ampere	Poles	110V	230V	400V	500V	>50V	>50V	Quantity	Each
		50-60 Hz	50-60 Hz	50-60 Hz	50-60 Hz	100-300Hz	301-500Hz		
63	4			120322	120387			5	625
63	5			120307				5	670

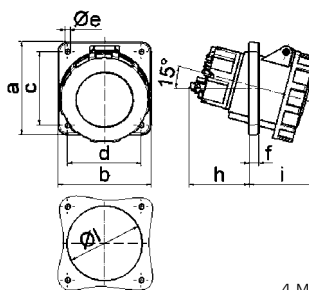

4 MB 270

Ampere	63	63
Poles	4	5
a	114,0	114,0
b	114,0	114,0
c	90,0	90,0
d	90,0	90,0
ø e	6,5	6,5
f	12,0	12,0
h	74,0	74,0
i	80,0	80,0
ø l	92,0	92,0
Cond. mm² min	6	6
Cond. mm² max	25	25

Panel Mounting Socket Outlet

- Screw terminals
- 15° angled
- Flange 114 x 114 mm
- High-temperature-resistant contact carrier
- Nickel plated contacts
- Kontex contact
- Box terminals
- Protection degree IP67
- Products with PILOT please add "P" to the ref.no.



12108

Ampere	Poles	110V	230V	400V	500V	>50V	>50V	Quantity	Each
		50-60 Hz	50-60 Hz	50-60 Hz	50-60 Hz	100-300Hz	301-500Hz		
125	3	1299	12100	12101				5	805
125	4	12102	12103	12104	12105	12320	12278	5	885
125	5	12106	12107	12108	12133	12334	12055	5	980

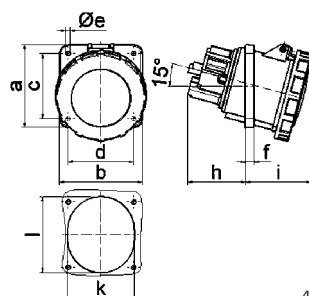

4 MB 9

Ampere	125	125	125
Poles	3	4	5
a	114,0	114,0	114,0
b	114,0	114,0	114,0
c	90,0	90,0	90,0
d	90,0	90,0	90,0
ø e	6,5	6,5	6,5
f	12,0	12,0	12,0
h	82,0	82,0	82,0
i	90,0	90,0	90,0
k	92,0	92,0	92,0
l	105,0	105,0	105,0
Cond. mm² min	25	25	25
Cond. mm² max	70	70	70

Panel Mounting Socket Outlet QUICK-CONNECT TE

- Screwless terminals
- Angled
- With NO and NC contact
- Flange 85 x 85 mm
- High-temperature-resistant contact carrier
- Nickel plated contacts
- Protection degree IP44

QUICK-CONNECT



120587

Ampere	Poles	110V 50-60 Hz	230V 50-60 Hz	400V 50-60 Hz	500V 50-60 Hz	>50V 100-300Hz	>50V 301-500Hz	Quantity	Each
		3pol 4pol 5pol 4h 4h 4h	3pol 4pol 5pol 6h 9h 9h	3pol 4pol 5pol 9h 6h 6h	3pol 4pol 5pol 7h 7h 7h	3pol 4pol 5pol 10h 10h 10h	3pol 4pol 5pol 2h 2h 2h		
16	3	120583	120584					10	140
16	4			120585	120586			10	155
16	5			120587				10	195
32	3	120588	120589					10	265
32	4			120590	120591			10	225
32	5			120592				10	265

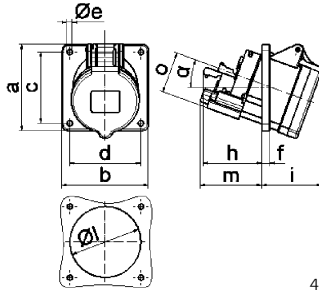

Ampere Poles	16 3	16 4	16 5	32 3	32 4	32 5
a	85,0	85,0	85,0	85,0	85,0	85,0
b	85,0	85,0	85,0	85,0	85,0	85,0
c	70,0	70,0	70,0	70,0	70,0	70,0
d	70,0	70,0	70,0	70,0	70,0	70,0
e	5,5	5,5	5,5	5,5	5,5	5,5
f	8,0	8,0	8,0	8,0	8,0	8,0
h	46,0	46,0	46,0	61,0	61,0	61,0
i	50,0	51,0	54,0	60,0	60,0	60,0
l	57,0	65,0	70,0	78,0	78,0	78,0
m	57,0	57,0	58,0	62,0	62,0	63,0
o	34,0	37,0	41,0	42,0	42,0	44,0
alpha	20°	20°	20°	20°	20°	20°

4 MB 76

Panel Mounting Socket Outlet QUICK-CONNECT TE

- Screwless terminals
- Angled
- With NO and NC contact
- Flange 85 x 85 mm
- High-temperature-resistant contact carrier
- Nickel plated contacts
- Protection degree IP67

QUICK-CONNECT



12650

Ampere	Poles	110V 50-60 Hz	230V 50-60 Hz	400V 50-60 Hz	500V 50-60 Hz	>50V 100-300Hz	>50V 301-500Hz	Quantity	Each
		3pol 4pol 5pol 4h 4h 4h	3pol 4pol 5pol 6h 9h 9h	3pol 4pol 5pol 9h 6h 6h	3pol 4pol 5pol 7h 7h 7h	3pol 4pol 5pol 10h 10h 10h	3pol 4pol 5pol 2h 2h 2h		
16	3	12648	121317					10	170
16	4			12649	12653			10	
16	5			12650				10	
32	3	12651	12646					10	270
32	4			12555	12652			10	
32	5			12596				10	355

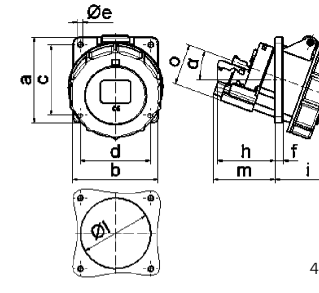

Ampere Poles	16 3	16 4	16 5	32 3	32 4	32 5
a	85,0	85,0	85,0	85,0	85,0	85,0
b	85,0	85,0	85,0	85,0	85,0	85,0
c	70,0	70,0	70,0	70,0	70,0	70,0
d	70,0	70,0	70,0	70,0	70,0	70,0
e	5,5	5,5	5,5	5,5	5,5	5,5
f	8,0	8,0	8,0	8,0	8,0	8,0
h	46,0	46,0	46,0	55,0	55,0	55,0
i	57,0	57,0	60,0	65,0	65,0	69,0
l	57,0	65,0	70,0	75,0	75,0	78,0
m	57,0	57,0	58,0	62,0	62,0	63,0
o	34,0	37,0	41,0	42,0	42,0	44,0
alpha	20°	20°	20°	20°	20°	20°

4 MB 78

Panel Mounting Socket Outlet

- Screw terminal
- 15° angled
- Flange 114 x 114 mm
- Drilling hole distance 90 x 90 mm
- With PSC-locking
- Kontex-Plus
- Box terminals
- Protection degree IP44



12616

Ampere	Poles	110V 50-60 Hz	230V 50-60 Hz	400V 50-60 Hz	500V 50-60 Hz	>50V 100-300Hz	>50V 301-500Hz	Quantity	Each
		3pol 4pol 5pol 4h 4h 4h	3pol 4pol 5pol 6h 9h 9h	3pol 4pol 5pol 9h 6h 6h	3pol 4pol 5pol 7h 7h 7h	3pol 4pol 5pol 10h 10h 10h	3pol 4pol 5pol 2h 2h 2h		
63	4			12360	12511			5	700
63	5			12616				5	750

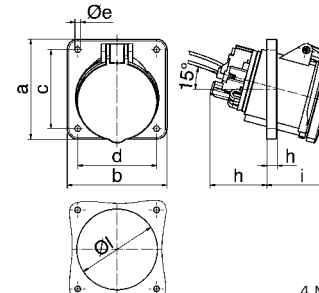

Ampere Poles	63 4	63 5
a	114,0	114,0
b	114,0	114,0
c	90,0	90,0
d	90,0	90,0
e	6,5	6,5
f	12,0	12,0
h	65,0	65,0
i	81,0	81,0
l	92,0	92,0
Cond. mm² min	6	6
Cond. mm² max	25	25

4 MB 388

Technical Information

- IEC 60309, EN 60309, VDE 0623

Panel Mounting Socket Outlet

- 15° angled
- Flange 114 x 114 mm
- Drilling hole distance 90 x 90 mm
- With PSC-locking
- Kontex-Plus
- Box terminals
- Protection degree IP67

Ampere	Poles	110V	230V	400V	500V	>50V	>50V	Quantity	Each
		50-60 Hz	50-60 Hz	50-60 Hz	50-60 Hz	100-300Hz	301-500Hz		
63	4	3pol 4pol 5pol	3pol 4pol 5pol	3pol 4pol 5pol	3pol 4pol 5pol	3pol 4pol 5pol	3pol 4pol 5pol	5	760
63	5							5	820
125	4							5	1230
125	5							5	1350



12025

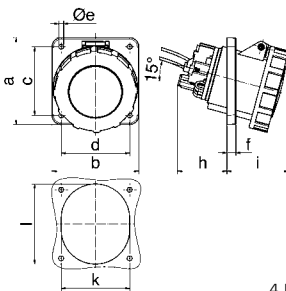

4 MB 192

Ampere	63	63	125	125
Poles	4	5	4	5
a	114,0	114,0	114,0	114,0
b	114,0	114,0	114,0	114,0
c	90,0	90,0	90,0	90,0
d	90,0	90,0	90,0	90,0
ø e	6,5	6,5	6,5	6,5
f	12,0	12,0	12,0	12,0
h	65,0	65,0	82,0	82,0
i	81,0	81,0	90,0	90,0
k	92,0	92,0	92,0	92,0
l	92,0	92,0	105,0	105,0
Cond. mm² min	6	6	25	25
Cond. mm² max	25	25	70	70

Panel Mounting Socket Outlet

- Straight insertion direction, also suitable for mounting in cable trunking and energy columns
- 16A version for cable trunk socket with mounting dimensions 70 x 70 mm
- 32A version for cable trunk socket with mounting dimensions 60 x 60 mm
- Protection degree IP44

Matching angled plug: see page 86/3

Ampere	Poles	110V	230V	400V	500V	>50V	>50V	Quantity	Each
		50-60 Hz	50-60 Hz	50-60 Hz	50-60 Hz	100-300Hz	301-500Hz		
16	3	3pol 4pol 5pol	3pol 4pol 5pol	3pol 4pol 5pol	3pol 4pol 5pol	3pol 4pol 5pol	3pol 4pol 5pol	10	185
16	5							10	215
32	5							10	290



13108

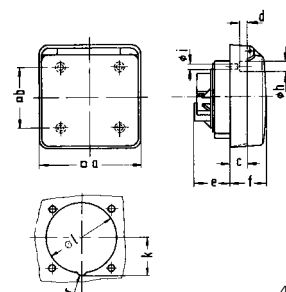

4 MB 14

Ampere	16	16	32
Poles	3	5	5
□ a	91,0	91,0	91,0
□ b	70,0	70,0	60,0
c	15,2	15,2	-
ø d	2,7	2,7	-
e	28,0	28,0	31,0
f	36,0	36,0	39,5
ø h	7,5	7,5	-
ø i	4,8	4,8	4,1
k	-	34,0	42,5
l	54,0	64,0	75,0
r	-	10,0	10,0
Cond. mm² min	1,5	1,5	2,5
Cond. mm² max	4	4	10

Flush Mounting Socket Outlet

- Flange 90 x 90 mm
- Drilling spacing 53 x 53 mm
- Protection degree IP44

Matching angled plug: see page 86/3

Ampere	Poles	110V	230V	400V	500V	>50V	>50V	Quantity	Each
		50-60 Hz	50-60 Hz	50-60 Hz	50-60 Hz	100-300Hz	301-500Hz		
16	3	3pol 4pol 5pol	3pol 4pol 5pol	3pol 4pol 5pol	3pol 4pol 5pol	3pol 4pol 5pol	3pol 4pol 5pol	10	215
16	5							10	245
32	5							10	400



146

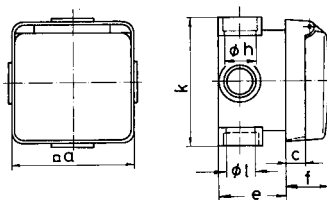

4 MB 15

Ampere	16	16	32
Poles	3	5	5
□ a	91,0	91,0	91,0
b	15,2	15,2	29,0
e	50,0	50,0	63,0
f	30,0	30,0	47,0
ø h	18,5	18,5	22,5
k	91,0	91,0	109,0
ø l	18,5	18,5	18,5
Cond. mm² min	1,5	1,5	2,5
Cond. mm² max	4	4	10

Sockets

Panel Mounting Socket Outlets

Technical Information

- IEC 60309, EN 60309, VDE 0623
- Particularly suitable for harsh operating conditions, especially resistant to aggressive atmospheres

Panel Mounting Socket Outlet QUICK-CONNECT TE

- Screwless terminals
- Kontex contact
- Flange 75 x 75 mm
- Straight
- High-temperature-resistant contact carrier
- Nickel plated contacts
- Protection degree IP44



13336

QUICK-CONNECT

Amperage	Poles	230V 50-60 Hz			400V 50-60 Hz			500V 50-60 Hz			Quantity	Each
		3pol 6h	4pol 9h	5pol 9h	3pol 9h	4pol 6h	5pol 6h	3pol 7h	4pol 7h	5pol 7h		
16	3	13144								10	110	
16	4				13334			13771			10	150
16	5				13336			130111			10	170
32	3	13773								10	215	
32	4				13774			13775			10	230
32	5				13777			13776			10	250

Panel Mounting Socket Outlet TE

- Screw terminals
- Flange 107 x 100 mm
- Straight
- High-temperature-resistant contact carrier
- Kontex contact and box terminals
- Nickel plated contacts
- Protection degree IP44



13343

Amperage	Poles	230V 50-60 Hz			400V 50-60 Hz			500V 50-60 Hz			Quantity	Each
		3pol 6h	4pol 9h	5pol 9h	3pol 9h	4pol 6h	5pol 6h	3pol 7h	4pol 7h	5pol 7h		
63	3	13341								5	420	
63	4				13342			13344			5	450
63	5				13343					5	495	

Panel Mounting Socket Outlet QUICK-CONNECT TE

- Screwless terminals
- Kontex contact
- Flange 74 x 62 mm for 16A 3p, 100 x 92 mm for the other versions
- 20° angled
- High-temperature-resistant contact carrier
- Nickel plated contacts
- Protection degree IP44



12884

QUICK-CONNECT

Amperage	Poles	230V 50-60 Hz			400V 50-60 Hz			500V 50-60 Hz			Quantity	Each
		3pol 6h	4pol 9h	5pol 9h	3pol 9h	4pol 6h	5pol 6h	3pol 7h	4pol 7h	5pol 7h		
16	3	12398								10	100	
16	4				12876			12877			10	150
16	5				12401			12878			10	165
32	3	12880								10	205	
32	4				12882			12883			10	215
32	5				12884			12884			10	255

Panel Mounting Socket Outlet TE

- Screw terminals
- Flange 114 x 114 mm
- 15° angled
- High-temperature-resistant contact carrier
- Kontex contact and box terminals
- Nickel plated contacts
- Protection degree IP44
- Products with PILOT please add "P" to the ref.no.



12408

Amperage	Poles	230V 50-60 Hz			400V 50-60 Hz			500V 50-60 Hz			Quantity	Each
		3pol 6h	4pol 9h	5pol 9h	3pol 9h	4pol 6h	5pol 6h	3pol 7h	4pol 7h	5pol 7h		
63	3	12405								5	420	
63	4				12406			12407			5	470
63	5				12408					5	510	

Panel Mounting Socket Outlets

Technical Information

- IEC 60309, EN 60309, VDE 0623
- Particularly suitable for harsh operating conditions, especially resistant to aggressive atmospheres

Panel Mounting Socket Outlet QUICK-CONNECT TE

- Screwless terminals
- Kontex contact
- Flange 75 x 75 mm
- Straight
- High-temperature-resistant contact carrier
- Nickel plated contacts
- Protection degree IP67



13816

QUICK-CONNECT

Ampere	Poles	230V 50-60 Hz			400V 50-60 Hz			500V 50-60 Hz			Quantity	Each
		3pol 6h	4pol 9h	5pol 9h	3pol 9h	4pol 6h	5pol 6h	3pol 7h	4pol 7h	5pol 7h		
16	3									10	145	
16	4									10	170	
16	5									10	200	
32	3									10	220	
32	4									10	230	
32	5									10	270	

Panel Mounting Socket Outlet TE

- Screw terminals
- Flange 107 x 100 mm
- Straight
- High-temperature-resistant contact carrier
- Kontex contact and box terminals
- Nickel plated contacts
- Protection degree IP67



13385

Ampere	Poles	230V 50-60 Hz			400V 50-60 Hz			500V 50-60 Hz			Quantity	Each
		3pol 6h	4pol 9h	5pol 9h	3pol 9h	4pol 6h	5pol 6h	3pol 7h	4pol 7h	5pol 7h		
63	3									5	480	
63	4									5	510	
63	5									5	550	

Panel Mounting Socket Outlet QUICK-CONNECT TE

- Screwless terminals
- Kontex contact
- Flange 74 x 62 mm for 16A 3p, 100 x 92 mm for the other versions
- 20° angled
- High-temperature-resistant contact carrier
- Nickel plated contacts
- Protection degree IP67



12928

QUICK-CONNECT

Ampere	Poles	230V 50-60 Hz			400V 50-60 Hz			500V 50-60 Hz			Quantity	Each
		3pol 6h	4pol 9h	5pol 9h	3pol 9h	4pol 6h	5pol 6h	3pol 7h	4pol 7h	5pol 7h		
16	3									10	145	
16	4									10	165	
16	5									10	205	
32	3									10	225	
32	4									10	250	
32	5									10	300	

Panel Mounting Socket Outlet TE

- Screw terminals
- Flange 114 x 114 mm
- 15° angled
- High-temperature-resistant contact carrier
- Kontex contact and box terminals
- Nickel plated contacts
- Protection degree IP67
- Products with PILOT please add "P" to the ref.no.



12160

Ampere	Poles	230V 50-60 Hz			400V 50-60 Hz			500V 50-60 Hz			Quantity	Each
		3pol 6h	4pol 9h	5pol 9h	3pol 9h	4pol 6h	5pol 6h	3pol 7h	4pol 7h	5pol 7h		
63	3									5	500	
63	4									5	535	
63	5									5	575	

Panel Mounting Socket Outlet TE

- Screw terminals
- Flange 114 x 114 mm
- 15° angled
- High-temperature-resistant contact carrier
- Kontex contact and box terminals
- Nickel plated contacts
- Protection degree IP67
- Products with PILOT please add "P" to the ref.no.



12108

Ampere	Poles	230V 50-60 Hz			400V 50-60 Hz			500V 50-60 Hz			Quantity	Each
		3pol 6h	4pol 9h	5pol 9h	3pol 9h	4pol 6h	5pol 6h	3pol 7h	4pol 7h	5pol 7h		
125	3									5	905	
125	4									5	965	
125	5									5	1070	

Mounting Frame

- For attaching panel mounting socket outlets

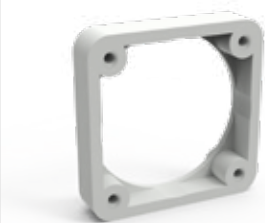

1843

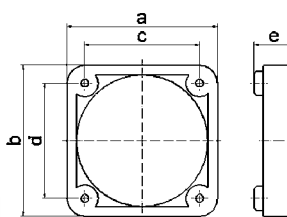

30 MB 182

a	b	c	d	e	Ref-No.
50	50	38	38	13	1843
54	54	44	44	10	1847
57	66	47	47	10	1848
60	60	50	50	10	1849
62	62	52	52	10	1850
62	70	52	60	10	1851

Mounting Frame

- For attaching panel mounting socket outlets

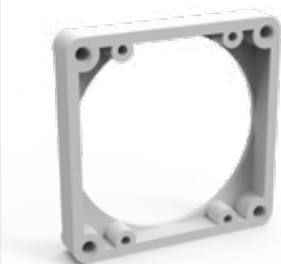

187

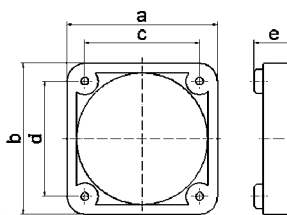

30 MB 182

a	b	c	d	e	Ref-No.
70	70	60	60	12	187
71	80	52	70	10	1852
80	80	70	70	13	189
87	95	77	85	12	188
100	110	90	90	10	1854

Intermediate Flange

- For attaching panel mounting socket outlets (straight)
- With screw terminal
- For QUICK-CONNECT 16A Panel Mounting Socket Outlets
- With flange 75 x 75 mm
- Drilling space 60 x 60 mm

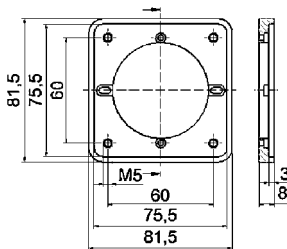
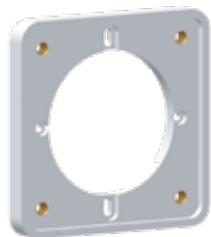

4 MB 256

Ref-No.

					182

Flush Mounting Box

- For panel mounting socket outlets
- Drilling space 60 x 60 mm
- Without terminals

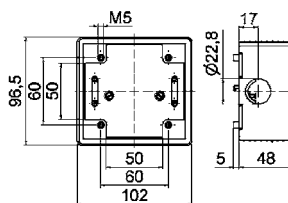
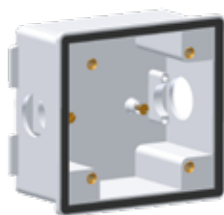

4 MB 13

Ref-No.

					183-BE

Touch Protection Ring

- for 63A, 5p and 125A 4/5p
- For attaching to contact carrier of panel mounting socket outlets



Ref-No.

63A	580634
125A	58058

Flush Box

- For panel mounting socket outlets listed on previous page



Ref-No.

180

1

Flush-Mounting Adapter

- For panel mounting socket outlets listed on previous page



Ref-No.

181

2

Empty Enclosure

- Dimension of enclosure 102 x 102 mm
- For panel mounting socket outlets with flange 75 x 75 mm
- Drilling spacing 60 x 60 mm



Ref-No.

für socket IP44 **18048**

für socket IP67 **18049**

4

Accessories for TK-Combi Socket Outlet



Ref-No.

Wiring harness 16A **1863**

Wiring harness 32A **1896**

G-fuse base 5x20mm DIN 41671 **1862**

G-fuse link 6,3A **1864**

G-fuse link 10A **1865**

G-fuse link 16A **1866**

replacement hinged lid domestic socket **33010594**

6

7

8





1

2

3

4





5

6





7

8





Plugs

Protection Degree IP44  Page 84	Protection Degree IP67  Pages 86 - 87	Lockable  Page 87	Angled Plugs  Page 87
--	--	--	---

Inlets

Surface Mounting Appliance Inlets  Pages 87 - 92	Panel Mounting Appliance Inlets  Pages 93 - 96	Appliance Inlets with Flange  Pages 97 - 100	Appliance Inlets with Flange for Harsh Conditions  Page 101
---	---	---	---

Phase Inverters

Plug  Page 102	Surface Mounting Appliance Inlet  Page 102	Panel Mounting Appliance Inlets  Page 102 - 103	Appliance Inlet with Flange  Page 103
---	--	---	--

Phase Sequence Indicators and Adapters

Phase Sequence Indicators  Page 104	Adapters  Page 104
--	---

Connectors

Protection Degree IP44  Page 105	Protection Degree IP67  Pages 106 - 107	Hanging Connectors  Page 107	Lockable  Page 107
Accessories Plugs and Connectors  Page 108			

Technical features

**Plugs and Connectors with MULTI-GRIP**

- Cable gland system with integrated strain relief
- Captive rubber seal
- MULTI-GRIP cable glands achieve at least protection class IP67
- Adaptation to all cable cross sections
- Status can be checked at any time from outside

**Plugs and Connectors with QUICK-CONNECT 16A and 32A**

- Patented, screwless quick connection technology, based on the familiar spring-clamp principle, with fully opened connection cavity
- Time saving up to 75%
- Faster, more reliable and controlled conductor connection
- The terminal accepts all types of copper conductors
- Quick-Connect is maintenance-free, shock resistant, vibrations and temperature fluctuations

**Plugs and Connectors with QUICK-CONNECT 63A**

- Worldwide unique screwless system for 63A CEE devices
- Same advantages as for the 16A and 32A systems
- Screwless box terminals
- Cable cross sections for flexible conductors: 6mm² - 16mm²
- Cable cross sections for rigid and multi-wire conductors: 6mm² - 25mm²

The following types of copper conductor can be used

- Fine-wire
- Single-wire
- Finely stranded with wire end ferrules
- With gas-tight crimp
- Ultrasonically welded

Plug QUICK-CONNECT with MULTI-GRIP

- Screwless terminals
- Screwless enclosure connection, self locking
- Special gland, simultaneous cable gland and seal
- Protection degree IP44

QUICK-CONNECT
MULTI-GRIP



2136

Ampere	Poles	110V 50-60 Hz	230V 50-60 Hz	400V 50-60 Hz	500V 50-60 Hz	>50V 100-300Hz	>50V 301-500Hz	Quantity	Each
		3pol 4pol 5pol 4h 4h 4h	3pol 4pol 5pol 6h 9h 9h	3pol 4pol 5pol 9h 6h 6h	3pol 4pol 5pol 7h 7h 7h	3pol 4pol 5pol 10h 10h 10h	3pol 4pol 5pol 2h 2h 2h		
16	3	2125	2126					10	100
16	4		2129	2130				10	135
16	5		2135	2136				10	140
32	3	2137	2138					10	250
32	4		2141	2142				10	220
32	5		2147	2148				10	295

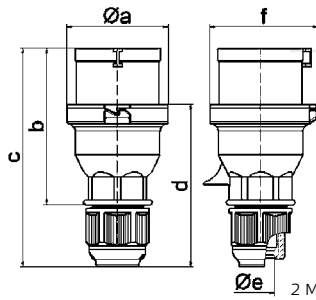

Ampere	16	16	16	32	32	32
Poles	3	4	5	3	4	5
Ø a	53,0	60,0	66,0	74,5	74,5	74,5
b	93,5	100,5	103,0	121,0	121,0	121,5
c	134,0	141,0	142,0	174,0	174,0	174,5
d	97,5	104,5	105,5	128,0	128,0	128,5
Ø e	18,0	18,0	18,0	23,0	23,0	23,0
f	57,5	64,5	70,5	78,0	78,0	80,0
Cond. mm² min	1	1	1	2,5	2,5	2,5
Cond. mm² max	2,5	2,5	2,5	6	6	6

Plug TE-Plus with MULTI-GRIP

- Screwless terminals
- High-temperature-resistant contact carrier
- Nickel plated contacts
- Special gland, simultaneous cable gland and seal
- Protection degree IP44

QUICK-CONNECT
MULTI-GRIP



21689

Ampere	Poles	110V 50-60 Hz	230V 50-60 Hz	400V 50-60 Hz	500V 50-60 Hz	>50V 100-300Hz	>50V 301-500Hz	Quantity	Each
		3pol 4pol 5pol 4h 4h 4h	3pol 4pol 5pol 6h 9h 9h	3pol 4pol 5pol 9h 6h 6h	3pol 4pol 5pol 7h 7h 7h	3pol 4pol 5pol 10h 10h 10h	3pol 4pol 5pol 2h 2h 2h		
16	3	21837	21686	21843	210169	210170	210171	10	125
16	4	21872	21839	21687	21688	21847	21849	10	145
16	5	210176	21840	21689	210178	210179	21879	10	180
32	3	21838	21690	21844	210184	210185	210186	10	240
32	4	21873	21841	21691	21692	21848	21850	10	260
32	5	210193	21842	21693	21623	210197	21885	10	310

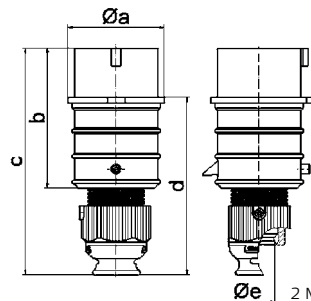

Ampere	16	16	16	32	32	32
Poles	3	4	5	3	4	5
Ø a	51,0	57,5	65,0	66,0	66,0	72,0
b	95,0	95,0	97,0	118,0	118,0	117,0
c	145,0	145,0	152,0	178,0	178,0	181,0
d	109,0	109,0	116,0	133,0	133,0	135,5
Ø e	18,0	18,0	21,0	23,0	23,0	27,0
Cond. mm² min	1	1	1	2,5	2,5	2,5
Cond. mm² max	2,5	2,5	2,5	6	6	6

Plug TE with MULTI-GRIP

- Nickel plated contacts
- Special gland, simultaneous cable gland and seal
- Screwless enclosure connection, self locking
- Protection degree IP44

MULTI-GRIP



2155

Ampere	Poles	110V 50-60 Hz	230V 50-60 Hz	400V 50-60 Hz	500V 50-60 Hz	>50V 100-300Hz	>50V 301-500Hz	Quantity	Each
		3pol 4pol 5pol 4h 4h 4h	3pol 4pol 5pol 6h 9h 9h	3pol 4pol 5pol 9h 6h 6h	3pol 4pol 5pol 7h 7h 7h	3pol 4pol 5pol 10h 10h 10h	3pol 4pol 5pol 2h 2h 2h		
63	4			210761	210763			5	660
63	5			210765				5	720
Screw terminal:									
63	3	21024	2104	21025	210030	21531	21624	5	535
63	4	2149	2150	2151	2152	21300	21526	5	595
63	5	2153	2154	2155	21167	21663	21419	5	650

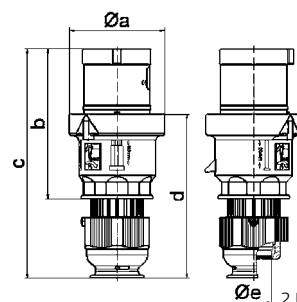

Ampere	63	63	63
Poles	3	4	5
Ø a	96,0	96,0	96,0
b	153,0	153,0	153,0
c	233,0	233,0	233,0
d	167,0	167,0	167,0
Ø e	36,0	36,0	36,0
Cond. mm² min	6	6	6
Cond. mm² max	16	16	16

Plug TE-Plus with MULTI-GRIP

- Screwless terminals
- High-temperature-resistant contact carrier
- Nickel plated contacts
- Special gland, simultaneous cable gland and seal
- Protection degree IP67

Accessories: Closure cap: see page 108/3

QUICK CONNECT
MULTI-GRIP



21239

	Ampere	Poles	110V 50-60 Hz	230V 50-60 Hz	400V 50-60 Hz	500V 50-60 Hz	>50V 100-300Hz	>50V 301-500Hz	Quantity	Each
			3pol 4pol 5pol 4h 4h 4h	3pol 4pol 5pol 6h 9h 9h	3pol 4pol 5pol 9h 6h 6h	3pol 4pol 5pol 7h 7h 7h	3pol 4pol 5pol 10h 10h 10h	3pol 4pol 5pol 2h 2h 2h		
16	3		21237	21238	21402	21487	21453	21558	10	150
16	4		21403	21250	21349	21350	21404	21405	10	175
16	5		21406	21407	21239	21754	21564	21533	10	215
32	3		21408	21240	21409	21486	21545	210222	10	285
32	4		21410	21251	21351	21352	21411	21412	10	335
32	5		21413	21414	21241	21282	21484	210234	10	385

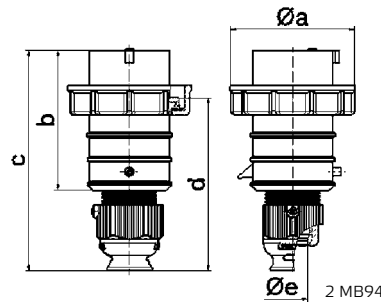

Ampere	16	16	16	32	32	32
Poles	3	4	5	3	4	5
Ø a	70,0	78,0	86,0	94,0	94,0	101,0
b	95,0	95,0	97,0	118,0	118,0	117,0
c	145,0	145,0	152,0	178,0	178,0	181,0
d	111,0	111,0	119,0	136,0	136,0	138,5
Ø e	18,0	18,0	21,0	23,0	23,0	27,0
Cond. mm² min	1	1	1	2,5	2,5	2,5
Cond. mm² max	2,5	2,5	2,5	6	6	6

Plug with MULTI-GRIP

- Screw terminals
- Nickel plated contacts
- One-piece enclosure
- Special gland, simultaneous cable gland and seal
- Protection degree IP67

MULTI-GRIP



210589

	Ampere	Poles	110V 50-60 Hz	230V 50-60 Hz	400V 50-60 Hz	500V 50-60 Hz	>50V 100-300Hz	>50V 301-500Hz	Quantity	Each
			3pol 4pol 5pol 4h 4h 4h	3pol 4pol 5pol 6h 9h 9h	3pol 4pol 5pol 9h 6h 6h	3pol 4pol 5pol 7h 7h 7h	3pol 4pol 5pol 10h 10h 10h	3pol 4pol 5pol 2h 2h 2h		
16	3		210575	210576	210577				10	155
16	4		210581	210582	210583				10	170
16	5		210587	210588	210589				10	170
32	3		210593	210594	210595				10	243
32	4		210599	210600	210601				10	255
32	5		210605	210606	210607				10	305

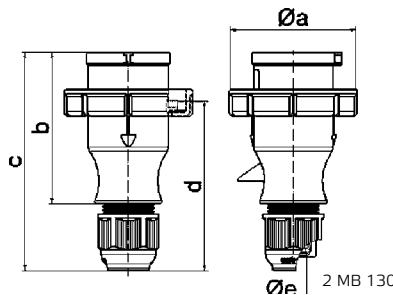

Ampere	16	16	16	32	32	32
Poles	3	4	5	3	4	5
Ø a	70,0	78,0	86,0	94,0	94,0	101,0
b	94,5	98,0	101,0	115,0	115,0	119,0
c	138,0	142,0	145,0	170,0	170,0	174,0
d	105,5	109,5	112,5	128,0	128,0	132,0
Ø e	18,0	18,0	18,0	23,0	23,0	23,0
Cond. mm² min	1	1	1	2,5	2,5	2,5
Cond. mm² max	2,5	2,5	2,5	6	6	6

Plug TE-Plus with MULTI-GRIP

- High-temperature-resistant contact carrier
- Nickel plated contacts
- Special gland, simultaneous cable gland and seal
- Screwless enclosure connection, self locking
- Protection degree IP67

Accessories: Closure cap: see page 108/3

MULTI-GRIP



210766

	Ampere	Poles	110V 50-60 Hz	230V 50-60 Hz	400V 50-60 Hz	500V 50-60 Hz	>50V 100-300Hz	>50V 301-500Hz	Quantity	Each
			3pol 4pol 5pol 4h 4h 4h	3pol 4pol 5pol 6h 9h 9h	3pol 4pol 5pol 9h 6h 6h	3pol 4pol 5pol 7h 7h 7h	3pol 4pol 5pol 10h 10h 10h	3pol 4pol 5pol 2h 2h 2h		
63	4				210762	210764			5	720
63	5				210766				5	770
Screw terminal:										
63	3		2180	2181	2182	21330			5	590
63	4		2183	2184	2185	2186	21154	21375	5	650
63	5		2187	2188	2189	21060	21645	21163	5	705

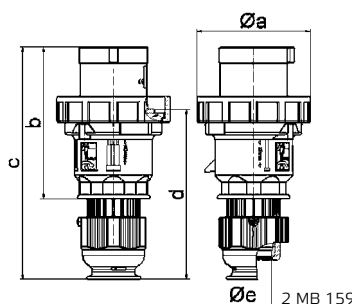

Ampere	63	63	63
Poles	3	4	5
Ø a	113,5	113,5	113,5
b	153,0	153,0	153,0
c	233,0	233,0	233,0
d	171,0	171,0	171,0
Ø e	36,0	36,0	36,0
Cond. mm² min	6	6	6
Cond. mm² max	16	16	16

Plugs and Connectors

Plugs Protection Degree IP44, Lockable Plugs and Angled Plugs

Technical Information

- IEC 60309-1/2, EN 60309, VDE 0623

Plug TE with MULTI-GRIP

- Screw terminals
- Box terminals
- High-temperature-resistant contact carrier
- Nickel plated contacts
- Special gland, simultaneous cable gland and seal
- Screwless enclosure connection, self locking
- Protection degree IP67

Accessories: closure cap, see page 108/3

MULTI-GRIP



2199

Ampere	Poles	110V	230V	400V	500V	>50V	>50V	Quantity	Each
		50-60 Hz	50-60 Hz	50-60 Hz	50-60 Hz	100-300Hz	301-500Hz		
125	3	2190	2191	2192	210964			5	1020
125	4	2193	2194	2195	2196	21607	21155	5	1125
125	5	2197	2198	2199	21555	21851	21156	5	1235

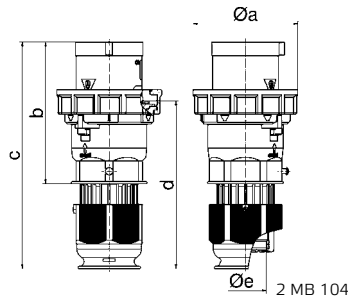

Ampere	125	125	125
Poles	3	4	5
Ø a	126,0	126,0	126,0
b	181,0	181,0	181,0
c	282,0	282,0	282,0
d	206,0	206,0	206,0
Ø e	50,0	50,0	50,0
Cond. mm² min	16	16	16
Cond. mm² max	50	50	50

Plug QUICK-CONNECT, lockable

- Screwless terminals
- Lockable with matching connector
- Screwless enclosure connection, self locking
- Special gland, simultaneous cable gland and seal
- Protection degree IP44

Accessories: Lock set, see page 108/5

QUICK-CONNECT
MULTI-GRIP

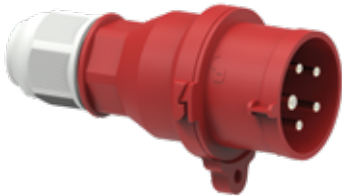

210951

Ampere	Poles	110V	230V	400V	500V	>50V	>50V	Quantity	Each
		50-60 Hz	50-60 Hz	50-60 Hz	50-60 Hz	100-300Hz	301-500Hz		
16	5			210950				10	180
32	5			210951				10	305

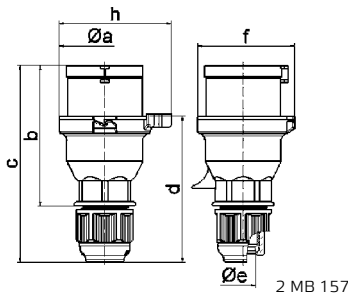

Ampere	16	32
Poles	5	5
a	66,0	74,5
b	103,0	121,5
c	142,0	174,5
d	105,5	128,5
Ø e	18,0	23,0
f	70,5	80,0
h	82,0	90,0
Cond. mm² min	1	2,5
Cond. mm² max	2,5	6

Angled Plug

- Screw terminals
- With short cable sleeve
- Protection degree IP44

231



Ampere	Poles	110V	230V	400V	500V	>50V	>50V	Quantity	Each
		50-60 Hz	50-60 Hz	50-60 Hz	50-60 Hz	100-300Hz	301-500Hz		
16	3		231					10	150
16	4			235				10	170
16	5			236				10	175
32	5			2300-BE				10	280

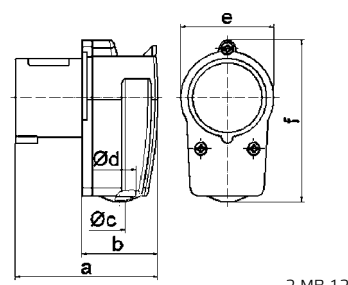

Ampere	16	16	16	32
Poles	3	4	5	5
a	80,0	85,0	96,0	116,0
b	44,0	49,0	59,0	70,0
Ø c	6,5	6,5	8,0	10,0
Ø d	18,0	18,0	18,0	25,0
e	51,0	57,0	64,0	-
f	90,0	95,0	74,0	101,0
Cond. mm² min	1	1	1	2,5
Cond. mm² max	2,5	2,5	2,5	6

Surface Mounting Appliance Inlet

- Screw terminals
- Cable entry 1x at top (open), 1x at bottom (closed)
- Protection degree IP44

Accessories: Closure cap, see page 108/3

3PHE 3PHE 3PHE		110V 50-60 Hz	230V 50-60 Hz	400V 50-60 Hz	500V 50-60 Hz	>50V 100-300Hz	>50V 301-500Hz	Quantity	Each
Ampere	Poles	3pol 4pol 5pol 4h 4h 4h	3pol 4pol 5pol 6h 9h 9h	3pol 4pol 5pol 9h 6h 6h	3pol 4pol 5pol 7h 7h 7h	3pol 4pol 5pol 10h 10h 10h	3pol 4pol 5pol 2h 2h 2h		
16	3	2448	240					10	115



240

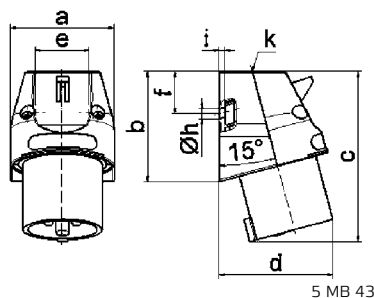

Ampere	Poles	16	3
a		56,5	
b		60,0	
c		93,0	
d		73,0	
e		29,5	
f		23,5	
ø h		5,5	
i		3,0	
k		M20	
Cond. mm² min		1	
Cond. mm² max		2,5	

Surface Mounting Appliance Inlet QUICK-CONNECT

- Screwless terminals
- Cable entry 1x at top (open), 1x at bottom (closed)
- Protection degree IP44

QUICK-CONNECT



242001

3PHE 3PHE 3PHE		110V 50-60 Hz	230V 50-60 Hz	400V 50-60 Hz	500V 50-60 Hz	>50V 100-300Hz	>50V 301-500Hz	Quantity	Each
Ampere	Poles	3pol 4pol 5pol 4h 4h 4h	3pol 4pol 5pol 6h 9h 9h	3pol 4pol 5pol 9h 6h 6h	3pol 4pol 5pol 7h 7h 7h	3pol 4pol 5pol 10h 10h 10h	3pol 4pol 5pol 2h 2h 2h		
16	3	24422	24423					10	170
16	4	24398	24393	24392	24539			10	180
16	5	24399	24400	242001				10	200
32	3	24401	24402					10	240
32	4	24403	24404	24405	24540			10	260
32	5	24406	24407	242002				10	260

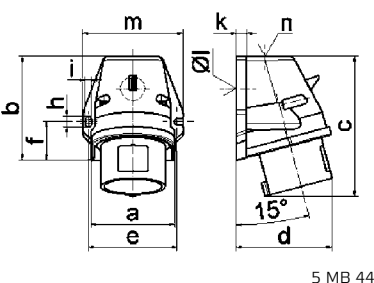

Ampere	Poles	16	16	16	32	32	32
		3	4	5	3	4	5
a		59,5	72,4	72,4	79,1	79,1	79,1
b		90,0	90,0	90,0	92,0	92,0	92,0
c		120,0	120,0	122,0	134,0	134,0	134,0
d		72,0	84,0	84,0	89,0	89,0	89,0
e		62,0	77,0	77,0	84,0	84,0	84,0
f		33,5	33,5	33,5	30,0	30,0	30,0
h		9,0	9,0	9,0	9,0	9,0	9,0
i		5,5	5,5	5,5	5,5	5,5	5,5
k		8,0	9,0	9,0	9,0	9,0	9,0
ø l		21,0	21,0	21,0	21,0	21,0	21,0
m		72,0	87,0	87,0	94,0	94,0	94,0
n		M20	M25	M25	M25	M25	M25
Cond. mm² min		1	1	1	2,5	2,5	2,5
Cond. mm² max		2,5	2,5	2,5	6	6	6

Surface Mounting Appliance Inlet

- Screw terminals
- Cable entry 1x at top (open), 1x at bottom and 1x at rear (closed)
- Protection degree IP44

3PHE 3PHE 3PHE		110V 50-60 Hz	230V 50-60 Hz	400V 50-60 Hz	500V 50-60 Hz	>50V 100-300Hz	>50V 301-500Hz	Quantity	Each
Ampere	Poles	3pol 4pol 5pol 4h 4h 4h	3pol 4pol 5pol 6h 9h 9h	3pol 4pol 5pol 9h 6h 6h	3pol 4pol 5pol 7h 7h 7h	3pol 4pol 5pol 10h 10h 10h	3pol 4pol 5pol 2h 2h 2h		
16	3		245					10	170
16	4			249				10	225
16	5				2415			10	255



2415

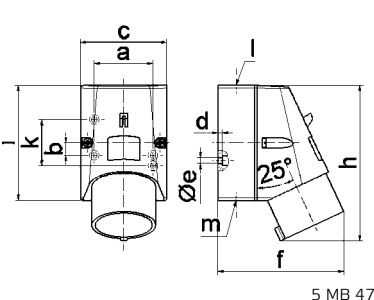

Ampere	Poles	16	16	16
		3	4	5
a		51,0	59,0	59,0
b		-	11,0	11,0
c		64,0	75,0	75,0
d		4,0	4,0	4,0
ø e		4,1	5,1	5,1
f		93,0	106,0	110,0
h		122,0	135,0	135,0
i		87,0	100,0	100,0
k		40,0	-	-
l		M20	M20	M20
m		for M20	for M20	for M20
Cond. mm² min		1	1	1
Cond. mm² max		2,5	2,5	2,5

Surface Mounting Appliance Inlet QUICK-CONNECT TE

- Screwless terminals
- High-temperature-resistant contact carrier
- Nickel plated contacts
- Cable entry 1x at top (open), 2x at bottom (closed)
- Base rotatable by 180°
- 4 mounting holes in enclosure base
- Suitable for through wiring
- Protection degree IP44

QUICK-CONNECT



24413

Amperage	Poles	110V 50-60 Hz			230V 50-60 Hz			400V 50-60 Hz			500V 50-60 Hz			>50V 100-300Hz			>50V 301-500Hz			Quantity	Each
		3pol	4pol	5pol	3pol	4pol	5pol	3pol	4pol	5pol	3pol	4pol	5pol	3pol	4pol	5pol	3pol	4pol	5pol		
16	5																		10	305	
32	3																		10	335	
32	4																		10	350	
32	5																		10	385	

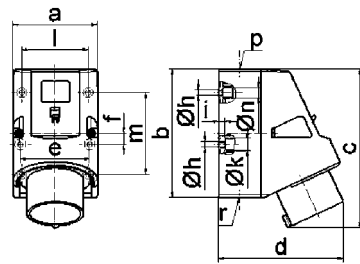

5 MB 45

Amperage	Poles	16	32	32	32
a	83,0	83,0	83,0	83,0	83,0
b	126,0	126,0	126,0	126,0	126,0
c	155,5	165,0	165,0	165,0	166,0
d	122,0	128,0	128,0	130,0	
e	68,0	68,0	68,0	68,0	
f	11,0	11,0	11,0	11,0	
ø h	5,5	5,5	5,5	5,5	
i	6,5	6,5	6,5	6,5	
ø k	12,0	12,0	12,0	12,0	
l	65,0	65,0	65,0	65,0	
m	80,0	80,0	80,0	80,0	
ø n	10,0	10,0	10,0	10,0	
p	M25	M25	M25	M25	
r	2xM25	2xM25	2xM25	2xM25	
Cond. mm² min		1	2,5	2,5	2,5
Cond. mm² max		2,5	6	6	6

Surface Mounting Appliance Inlet

- Screw terminals
- Cable entry 1x at top (open) and 2x at bottom (closed)
- Base rotatable by 180°
- Protection degree IP44



24134

Amperage	Poles	110V 50-60 Hz			230V 50-60 Hz			400V 50-60 Hz			500V 50-60 Hz			>50V 100-300Hz			>50V 301-500Hz			Quantity	Each
		3pol	4pol	5pol	3pol	4pol	5pol	3pol	4pol	5pol	3pol	4pol	5pol	3pol	4pol	5pol					
63	3																	5	775		
63	4																	5	925		
63	5																	5	975		

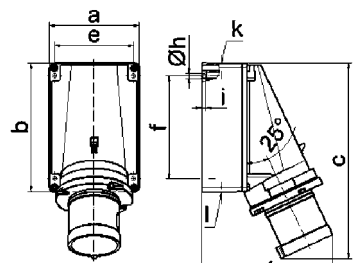

5 MB 48

Amperage	Poles	63	63	63
a	118,0	118,0	118,0	118,0
b	170,0	170,0	170,0	170,0
c	259,0	259,0	259,0	259,0
d	174,0	174,0	174,0	174,0
e	104,0	104,0	104,0	104,0
f	136,0	136,0	136,0	136,0
ø h	6,1	6,1	6,1	6,1
i	6,0	6,0	6,0	6,0
k	M40	M40	M40	M40
l	M32/32	M32/32	M32/32	M32/32
Cond. mm² min		6	6	6
Cond. mm² max		16	16	16

Surface Mounting Appliance Inlet

- Screw terminals
- With hinged lid
- Protection degree IP44

3P+E	3P+E	3+N+E	110V 50-60 Hz	230V 50-60 Hz	400V 50-60 Hz	500V 50-60 Hz	>50V 100-300Hz	>50V 301-500Hz
3pol	4pol	5pol	4h	4h	4h	3pol 4pol 5pol 6h 9h 9h	3pol 4pol 5pol 9h 6h 6h	3pol 4pol 5pol 7h 7h 7h
Ampere		Poles						

16 3 **242** 10 150



242

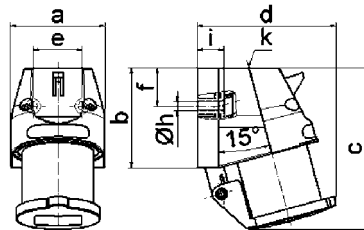

Ampere	16
Poles	3
a	56,5
b	60,0
c	97,5
d	84,0
e	29,5
f	23,0
ø h	5,5
i	16,0
k	M20
Cond. mm ² min	1
Cond. mm ² max	2,5

5 MB 17

Surface Mounting Appliance Inlet

- Screw terminals
- With closure cap
- Protection degree IP44

3P+E	3P+E	3+N+E	110V 50-60 Hz	230V 50-60 Hz	400V 50-60 Hz	500V 50-60 Hz	>50V 100-300Hz	>50V 301-500Hz
3pol	4pol	5pol	4h	4h	4h	3pol 4pol 5pol 6h 9h 9h	3pol 4pol 5pol 9h 6h 6h	3pol 4pol 5pol 7h 7h 7h
Ampere		Poles						

16 3 **2400** 10 140



2400

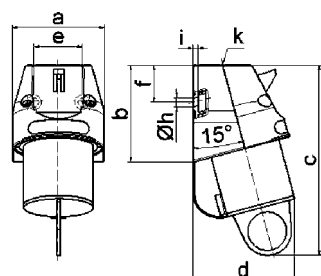

Ampere	16
Poles	3
a	56,5
b	60,0
c	118,0
d	63,0
e	29,5
f	23,0
ø h	5,5
i	3,0
k	M20
Cond. mm ² min	1
Cond. mm ² max	2,5

5 MB 60

Surface Mounting Appliance Inlet

- Screw terminals
- With hinged lid
- Protection degree IP44

3P+E	3P+E	3+N+E	110V 50-60 Hz	230V 50-60 Hz	400V 50-60 Hz	500V 50-60 Hz	>50V 100-300Hz	>50V 301-500Hz
3pol	4pol	5pol	4h	4h	4h	3pol 4pol 5pol 6h 9h 9h	3pol 4pol 5pol 9h 6h 6h	3pol 4pol 5pol 7h 7h 7h
Ampere		Poles						

16 3 **2461** 10 205

16 4 **2465** 10 255



2465

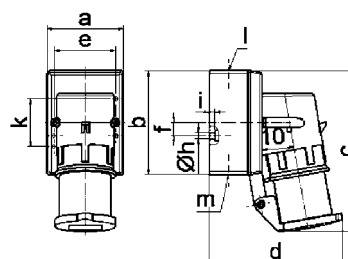

Ampere	16	16
Poles	3	4
a	64,0	75,0
b	87,0	100,0
c	138,0	150,0
d	111,0	120,0
e	51,0	59,0
f	-	11,0
ø h	4,1	5,1
i	4,5	4,5
k	40,0	-
l	M20	M20
m	for M20	for M20
Cond. mm ² min	1	1
Cond. mm ² max	2,5	2,5

5 MB 10

Surface Mounting Appliance Inlet

- Screw terminals
- With hinged lid
- Protection degree IP44



Ampere	Poles	110V 50-60 Hz	230V 50-60 Hz	400V 50-60 Hz	500V 50-60 Hz	>50V 100-300Hz	>50V 301-500Hz	Quantity	Each
16	5	2469	2470	2471				10	270
32	3	24335	24017					10	335
32	4			24018	24019			10	330
32	5			24012				10	350



24012

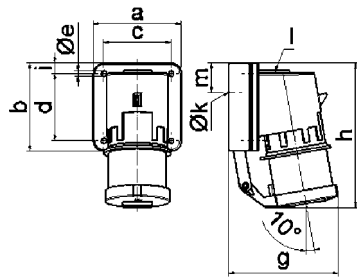

Ampere	Poles	16	32	32	32
a	84,0	90,0	90,0	90,0	90,0
b	84,0	75,0	75,0	75,0	75,0
c	64,0	78,0	78,0	78,0	78,0
d	64,0	45,0	45,0	45,0	45,0
ø e	5,5	5,5	5,5	5,5	5,5
g	105,0	114,0	114,0	115,0	115,0
h	138,0	149,0	149,0	150,0	150,0
i	10,0	13,0	13,0	13,0	13,0
ø k	23,0	29,0	29,0	29,0	29,0
l	M20	M25	M25	M25	M25
m	28,0	27,0	27,0	27,0	27,0
Cond. mm² min	1	2,5	2,5	2,5	2,5
Cond. mm² max	2,5	6	6	6	6

5 MB 12

Surface Mounting Appliance Inlet QUICK-CONNECT TE

- Screwless terminals
- With hinged lid
- High-temperature-resistant contact carrier
- Nickel plated contacts
- Protection degree IP44



Ampere	Poles	110V 50-60 Hz	230V 50-60 Hz	400V 50-60 Hz	500V 50-60 Hz	>50V 100-300Hz	>50V 301-500Hz	Quantity	Each
16	5			24414				10	270
32	5			24415				10	370



24415

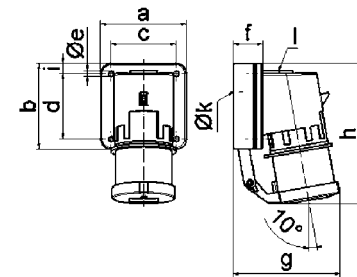

Ampere	Poles	16	32
a	84,0	90,0	
b	84,0	75,0	
c	64,0	78,0	
d	64,0	45,0	
ø e	5,5	5,5	
f	29,0	29,0	
g	105,0	115,0	
h	138,0	150,0	
i	10,0	13,0	
ø k	23,0	29,0	
l	M20	M25	
Cond. mm² min	1	2,5	
Cond. mm² max	2,5	6	

5 MB 96

QUICK-CONNECT

Surface Mounting Appliance Inlet

- Screw terminals
- Nickel plated contacts
- Terminal for 1 mm² to 2.5 mm² conductor for 16A
- Terminal for 2.5 mm² to 6 mm² conductor for 32A
- Protection degree IP67

Accessories: Closure cap: see page 108/3



2483

Amperage	Poles	110V	230V	400V	500V	>50V	>50V	Quantity	Each
		50-60 Hz	50-60 Hz	50-60 Hz	50-60 Hz	100-300Hz	301-500Hz		
3pol	4pol	5pol	3pol	4pol	5pol	3pol	4pol	5pol	
4h	4h	4h	6h	9h	9h	10h	10h	10h	
16	3	2472	2473	2474				10	205
16	4	2475	2476	2477	2478	2479	2480	10	245
16	5	2481	2482	2483	24114			10	265
32	3	24154	24020					10	310
32	4		24101	24021	24022			10	325
32	5			2402	24079			10	340

Amperage	Poles	16	16	16	32	32	32
Poles		3	4	5	3	4	5
a		64,0	75,0	84,0	90,0	90,0	90,0
b		87,0	100,0	84,0	75,0	75,0	75,0
c		137,0	151,0	136,0	138,0	138,0	139,0
d		112,0	119,0	-	122,0	122,0	123,0
e		51,0	59,0	-	-	-	-
f		-	11,0	-	-	-	-
ø h		4,1	5,1	-	-	-	-
i		4,5	4,5	-	-	-	-
k		40,0	-	-	-	-	-
l		-	-	111,0	-	-	-
m		-	-	64,0	78,0	78,0	78,0
n		-	-	64,0	45,0	45,0	45,0
ø o		-	-	5,5	5,5	5,5	5,5
p		M20	M20	-	-	-	-
r		-	-	M20	M25	M25	M25
ø s		-	-	23,0	29,0	29,0	29,0
t		for M20	for M20	-	-	-	-

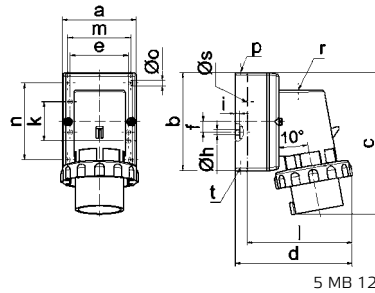

5 MB 128

Surface Mounting Appliance Inlet

- Screw terminals
- With closure cap
- Nickel plated contacts
- Terminal for 1 mm² to 2.5 mm² conductor for 16A
- Terminal for 2.5 mm² to 6 mm² conductor for 32A
- Protection degree IP67



2495

Amperage	Poles	110V	230V	400V	500V	>50V	>50V	Quantity	Each
		50-60 Hz	50-60 Hz	50-60 Hz	50-60 Hz	100-300Hz	301-500Hz		
3pol	4pol	5pol	3pol	4pol	5pol	3pol	4pol	5pol	
4h	4h	4h	6h	9h	9h	10h	10h	10h	
16	3	2484	2485	2486				10	245
16	4	2487	2488	2489	2490	2491	2492	10	350
16	5	2493	2494	2495				10	315
32	3	24216	24023					10	370
32	4			24024	24025			10	395
32	5			24013	24089	24078		10	410

Amperage	Poles	16	16	16	32	32	32
Poles		3	4	5	3	4	5
a		64,0	75,0	84,0	90,0	90,0	90,0
b		87,0	100,0	84,0	75,0	75,0	75,0
c		137,0	151,0	137,0	147,0	147,0	148,0
d		112,0	119,0	-	122,0	122,0	123,0
e		51,0	59,0	-	-	-	-
f		-	11,0	-	-	-	-
ø h		4,1	5,1	-	-	-	-
i		4,5	4,5	-	-	-	-
k		40,0	-	-	-	-	-
l		-	-	111,0	-	-	-
m		-	-	64,0	78,0	78,0	78,0
n		-	-	64,0	45,0	45,0	45,0
ø o		-	-	5,5	5,5	5,5	5,5
p		M20	M20	-	-	-	-
r		-	-	M20	M25	M25	M25
ø s		-	-	23,0	29,0	29,0	29,0
t		for M20	for M20	-	-	-	-

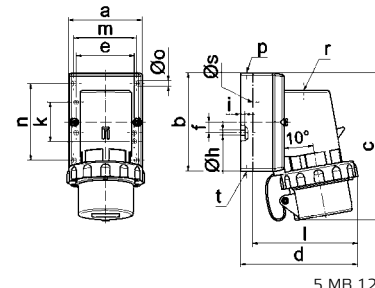

5 MB 127

Surface Mounting Appliance Inlet QUICK-CONNECT TE

- Screwless terminal
- Nickel plated contacts
- Terminal for 1 mm² to 2.5 mm² conductor for 16A
- Terminal for 2.5 mm² to 6 mm² conductor for 32A
- Protection degree IP67

Accessories: Closure cap: see page 108/3

QUICK-CONNECT



24418

Amperage	Poles	110V	230V	400V	500V	>50V	>50V	Quantity	Each
		50-60 Hz	50-60 Hz	50-60 Hz	50-60 Hz	100-300Hz	301-500Hz		
3pol	4pol	5pol	3pol	4pol	5pol	3pol	4pol	5pol	
4h	4h	4h	6h	9h	9h	10h	10h	10h	
16	5			24416				10	275
32	5			24418				10	355

Amperage	Poles	16	32
Poles		5	5
a		84,0	90,0
b		84,0	75,0
c		64,0	78,0
d		64,0	45,0
ø e		5,5	5,5
f		28,0	28,0
g		111,0	123,0
h		136,0	139,0
i		10,0	13,0
ø k		23,0	29,0
l		M20	M25

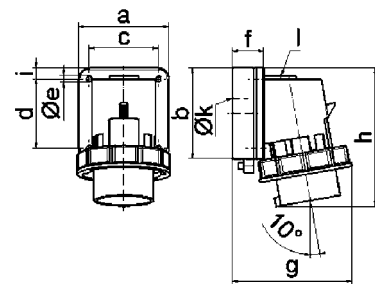

5 MB 129

Surface Mounting Appliance Inlet QUICK-CONNECT TE

- Screwless terminal
- With closure cap
- Nickel plated contacts
- Terminal for 1 mm² to 2.5 mm² conductor for 16A
- Terminal for 2.5 mm² to 6 mm² conductor for 32A
- Protection degree IP67

QUICK-CONNECT



24419

		110V 50-60 Hz			230V 50-60 Hz			400V 50-60 Hz			500V 50-60 Hz			>50V 100-300Hz			>50V 301-500Hz			Quantity	Each
Ampere	Poles	3pol	4pol	5pol	3pol	4pol	5pol	3pol	4pol	5pol	3pol	4pol	5pol	3pol	4pol	5pol	3pol	4pol	5pol		
16	5																			10	340
32	5																			10	430

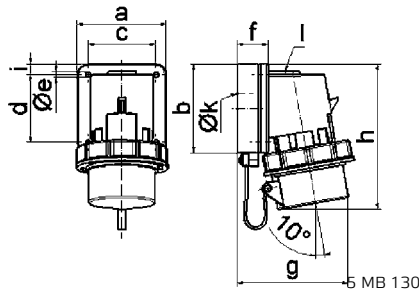

Ampere Poles	16 5	32 5
a	84,0	90,0
b	84,0	75,0
c	64,0	78,0
d	64,0	45,0
ø e	5,5	5,5
f	28,0	28,0
g	111,0	123,0
h	137,0	148,0
i	10,0	13,0
ø k	23,0	29,0
l	M20	M25

Surface Mounting Appliance Inlet

- Screw terminals
- Box terminals
- Cable entry 1x at top (open), 2x at bottom (closed)
- Base rotatable by 180°
- Nickel plated contacts
- Protection degree IP67

Accessories: closure cap, see page 108/3



24062

		110V 50-60 Hz			230V 50-60 Hz			400V 50-60 Hz			500V 50-60 Hz			>50V 100-300Hz			>50V 301-500Hz			Quantity	Each
Ampere	Poles	3pol	4pol	5pol	3pol	4pol	5pol	3pol	4pol	5pol	3pol	4pol	5pol	3pol	4pol	5pol	3pol	4pol	5pol		
63	3																			5	845
63	4																			5	990
63	5																			5	1040

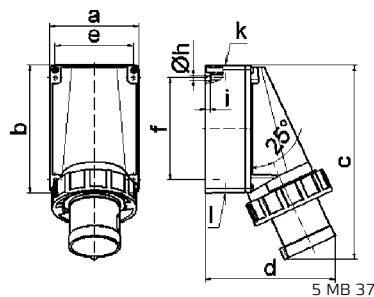

Ampere Poles	63 3	63 4	63 5
a	118,0	118,0	118,0
b	170,0	170,0	170,0
c	259,0	259,0	259,0
d	174,0	174,0	174,0
e	104,0	104,0	104,0
f	136,0	136,0	136,0
ø h	6,1	6,1	6,1
i	6,0	6,0	6,0
k	M40	M40	M40
l	M32/32	M32/32	M32/32
Cond. mm ² min	6	6	6
Cond. mm ² max	16	16	16

Surface Mounting Appliance Inlet

- Screw terminals
- Box terminals
- High-temperature-resistant contact carrier
- Nickel plated contacts
- Protection degree IP67

Accessories: closure cap, see page 108/3



24202

		110V 50-60 Hz			230V 50-60 Hz			400V 50-60 Hz			500V 50-60 Hz			>50V 100-300Hz			>50V 301-500Hz			Quantity	Each
Ampere	Poles	3pol	4pol	5pol	3pol	4pol	5pol	3pol	4pol	5pol	3pol	4pol	5pol	3pol	4pol	5pol	3pol	4pol	5pol		
125	3																			1	1835
125	4																			1	2140
125	5																			1	2245

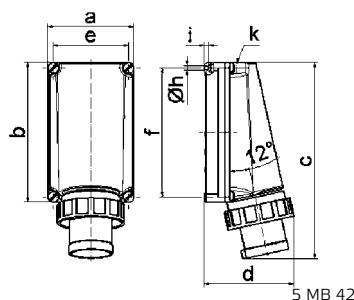

Ampere Poles	125 3	125 4	125 5
a	160,0	160,0	160,0
b	260,0	260,0	260,0
c	364,0	364,0	364,0
d	165,0	165,0	165,0
e	140,0	140,0	140,0
f	240,0	240,0	240,0
ø h	8,3	8,3	8,3
i	10,0	10,0	10,0
k	M50	M50	M50
Cond. mm ² min	16	16	16
Cond. mm ² max	50	50	50

**Panel Mounting Appliance Inlet
QUICK-CONNECT TE**

- Screwless terminals
- High-temperature-resistant contact carrier
- Nickel plated contacts
- Protection degree IP44



110V
50-60 Hz
3pol 4pol 5pol
4h 4h 4h

230V
50-60 Hz
3pol 4pol 5pol
6h 9h 9h

400V
50-60 Hz
3pol 4pol 5pol
9h 6h 6h

500V
50-60 Hz
3pol 4pol 5pol
7h 7h 7h

>50V
100-300Hz
3pol 4pol 5pol
10h 10h 10h

>50V
301-500Hz
3pol 4pol 5pol
2h 2h 2h

Quantity Each

16	5	26050	10	180
32	5	26051	10	265

QUICK-CONNECT



26050

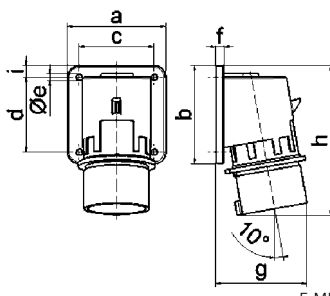

Ampere	16	32
Poles	5	5
a	84,0	90,0
b	84,0	75,0
c	64,0	78,0
d	64,0	45,0
ø e	5,5	5,5
f	7,0	7,0
g	78,0	88,0
h	129,0	139,0
i	10,0	13,0
ø k	23,0	29,0
l	M20	M25
Cond. mm² min	1	2,5
Cond. mm² max	2,5	6

5 MB 92

**Panel Mounting Appliance Inlet
QUICK-CONNECT TE**

- Screwless terminals
- With hinged lid
- High-temperature-resistant contact carrier
- Nickel plated contacts
- Protection degree IP44



110V
50-60 Hz
3pol 4pol 5pol
4h 4h 4h

230V
50-60 Hz
3pol 4pol 5pol
6h 9h 9h

400V
50-60 Hz
3pol 4pol 5pol
9h 6h 6h

500V
50-60 Hz
3pol 4pol 5pol
7h 7h 7h

>50V
100-300Hz
3pol 4pol 5pol
10h 10h 10h

>50V
301-500Hz
3pol 4pol 5pol
2h 2h 2h

Quantity Each

16	5	26052	10	275
32	5	26053	10	355

QUICK-CONNECT



26052

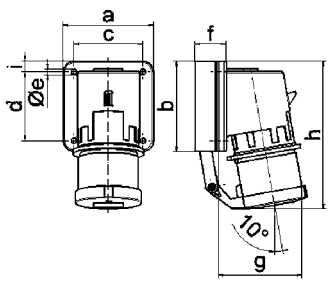

Ampere	16	32
Poles	5	5
a	84,0	90,0
b	84,0	75,0
c	64,0	78,0
d	64,0	45,0
ø e	5,5	5,5
f	29,0	29,0
g	105,0	115,0
h	138,0	150,0
i	10,0	13,0
Cond. mm² min	1	2,5
Cond. mm² max	2,5	6

5 MB 93

Panel Mounting Appliance Inlet QUICK-CONNECT TE

- Screwless terminals
- High-temperature-resistant contact carrier
- Nickel plated contacts
- Protection degree IP67

Accessories: Closure cap page 108/3

QUICK-CONNECT



26054

20A-E		30A-E		34N+E		110V 50-60 Hz			230V 50-60 Hz			400V 50-60 Hz			500V 50-60 Hz			>50V 100-300Hz			>50V 301-500Hz			Quantity	Each
Ampere	Poles	3pol	4pol	5pol	3pol	4pol	5pol	3pol	4pol	5pol	3pol	4pol	5pol	3pol	4pol	5pol	3pol	4pol	5pol	2h	2h	2h			
16	5																						10	210	
32	5																						10	300	

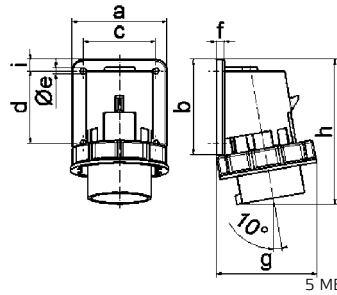

Ampere	16	32
Poles	5	5
a	84,0	90,0
b	84,0	75,0
c	64,0	78,0
d	64,0	45,0
ø e	5,5	5,5
f	7,0	7,0
g	90,0	101,0
h	129,0	139,0
i	10,0	13,0
Cond. mm² min	1	2,5
Cond. mm² max	2,5	6

5 MB 88

Panel Mounting Appliance Inlet QUICK-CONNECT TE

- With closure cap
- High-temperature-resistant contact carrier
- Nickel plated contacts
- Protection degree IP67

QUICK-CONNECT



26056

20A-E		30A-E		34N+E		110V 50-60 Hz			230V 50-60 Hz			400V 50-60 Hz			500V 50-60 Hz			>50V 100-300Hz			>50V 301-500Hz			Quantity	Each
Ampere	Poles	3pol	4pol	5pol	3pol	4pol	5pol	3pol	4pol	5pol	3pol	4pol	5pol	3pol	4pol	5pol	3pol	4pol	5pol	2h	2h	2h			
16	5																						10	335	
32	5																						10	425	

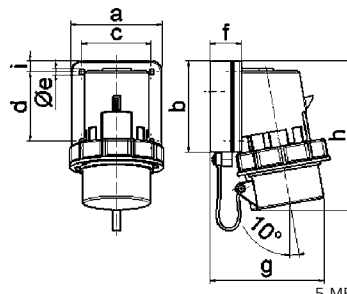

Ampere	16	32
Poles	5	5
a	84,0	90,0
b	84,0	75,0
c	64,0	78,0
d	64,0	45,0
ø e	5,5	5,5
f	28,0	28,0
g	111,0	123,0
h	137,0	148,0
i	10,0	13,0
Cond. mm² min	1	2,5
Cond. mm² max	2,5	6

5 MB 89

Panel Mounting Appliance Inlet

- Screw terminals
- Protection degree IP44



110V
50-60 Hz
3pol 4pol 5pol
4h 4h 4h

230V
50-60 Hz
3pol 4pol 5pol
6h 9h 9h

400V
50-60 Hz
3pol 4pol 5pol
9h 6h 6h

500V
50-60 Hz
3pol 4pol 5pol
7h 7h 7h

>50V
100-300Hz
3pol 4pol 5pol
10h 10h 10h

>50V
301-500Hz
3pol 4pol 5pol
2h 2h 2h



9

Quantity Each

16	3	260	261	262				10	140
16	4	263	264	265	266	267	268	10	180
16	5	2610	2611	2612	2649		26036	10	180
32	3		2662					10	200
32	4	26026	2684	2663	2664	2679	26028	10	225
32	5	26023	26030	2600	26065		26029	10	230



2612

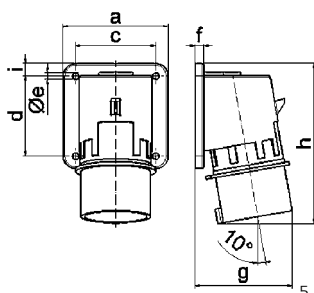

Ampere	16	16	16	32	32	32
Poles	3	4	5	3	4	5
a	74,0	75,0	84,0	90,0	90,0	90,0
b	84,0	100,0	84,0	75,0	75,0	75,0
c	58,0	62,0	64,0	78,0	78,0	78,0
d	64,0	74,0	64,0	45,0	45,0	45,0
ø e	5,5	4,3	5,5	5,5	5,5	5,5
f	12,0	12,0	7,0	7,0	7,0	7,0
g	70,0	77,0	78,0	86,0	86,0	88,0
h	128,0	145,0	129,0	138,0	138,0	140,0
i	-	-	-	13,0	13,0	13,0
Cond. mm² min	1	1	1	2,5	2,5	2,5
Cond. mm² max	2,5	2,5	2,5	6	6	6

5 MB 24

Panel Mounting Appliance Inlet

- Screw terminals
- With hinged lid
- Protection degree IP44



110V
50-60 Hz
3pol 4pol 5pol
4h 4h 4h

230V
50-60 Hz
3pol 4pol 5pol
6h 9h 9h

400V
50-60 Hz
3pol 4pol 5pol
9h 6h 6h

500V
50-60 Hz
3pol 4pol 5pol
7h 7h 7h

>50V
100-300Hz
3pol 4pol 5pol
10h 10h 10h

>50V
301-500Hz
3pol 4pol 5pol
2h 2h 2h



9

Quantity Each

16	3	2625	2626	2627				10	165
16	4	2628	2629	2630	2631	2632	2633	10	200
16	5	2634	2635	2636	2671			10	265
32	3		2656					10	300
32	4		2685	2657	2658			10	315
32	5	26015		2655				10	340



2655

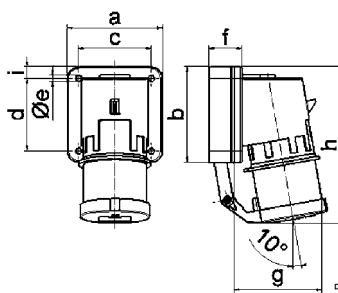

Ampere	16	16	16	32	32	32
Poles	3	4	5	3	4	5
a	74,0	75,0	84,0	90,0	90,0	90,0
b	84,0	100,0	84,0	75,0	75,0	75,0
c	58,0	62,0	64,0	78,0	78,0	78,0
d	64,0	74,0	64,0	45,0	45,0	45,0
ø e	5,5	4,3	5,5	5,5	5,5	5,5
f	12,0	12,0	29,0	29,0	29,0	29,0
g	78,0	88,0	105,0	114,0	114,0	115,0
h	134,0	151,0	138,0	149,0	149,0	150,0
i	-	-	-	13,0	13,0	13,0
Cond. mm² min	1	1	1	2,5	2,5	2,5
Cond. mm² max	2,5	2,5	2,5	6	6	6

5 MB 2

Panel Mounting Appliance Inlet

- Screw terminals
- Nickel plated contacts
- Protection degree IP67

Accessories: Closure cap: see page 108/3



2601

Ampere	Poles	110V 50-60 Hz			230V 50-60 Hz			400V 50-60 Hz			>50V 100-300Hz			>50V 301-500Hz			Quantity	Each
		3pol	4pol	5pol	3pol	4pol	5pol	3pol	4pol	5pol	3pol	4pol	5pol	3pol	4pol	5pol		
16	3			2613			2614			2615							10	160
16	4			2616			2617			2618			2619	2620	2621		10	180
16	5			2622			2623			2624			2650				10	205
32	3			26033			2665										10	250
32	4						2694			2666			2667				10	265
32	5									2601							10	280

Ampere	Poles	16	16	16	32	32	32
a	74,0	75,0	84,0	90,0	90,0	90,0	90,0
b	84,0	100,0	84,0	75,0	75,0	75,0	75,0
c	58,0	62,0	64,0	78,0	78,0	78,0	78,0
d	64,0	74,0	64,0	45,0	45,0	45,0	45,0
ø e	5,5	4,3	5,5	5,5	5,5	5,5	5,5
f	12,0	12,0	7,0	7,0	7,0	7,0	7,0
g	80,0	88,0	90,0	100,0	100,0	101,0	101,0
h	128,0	145,0	129,0	138,0	138,0	139,0	139,0
i	-	-	10,0	13,0	13,0	13,0	13,0
Cond. mm² min	1	1	1	2,5	2,5	2,5	2,5
Cond. mm² max	2,5	2,5	2,5	6	6	6	6

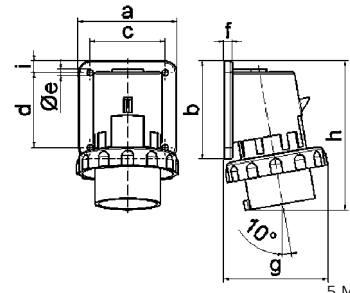

5 MB 1

Panel Mounting Appliance Inlet

- Screw terminals
- With closure cap
- Nickel plated contacts
- Protection degree IP67



2604

Ampere	Poles	110V 50-60 Hz			230V 50-60 Hz			400V 50-60 Hz			>50V 100-300Hz			>50V 301-500Hz			Quantity	Each
		3pol	4pol	5pol	3pol	4pol	5pol	3pol	4pol	5pol	3pol	4pol	5pol	3pol	4pol	5pol		
16	3			2637			2638			2639							10	200
16	4			2640			2641			2642			2643	2644	2645		10	280
16	5			2646			2647			2648							10	310
32	3						2659										10	370
32	4									2660			2661				10	390
32	5									2604							10	405

Ampere	Poles	16	16	16	32	32	32
a	74,0	75,0	84,0	90,0	90,0	90,0	90,0
b	84,0	100,0	84,0	75,0	75,0	75,0	75,0
c	58,0	62,0	64,0	78,0	78,0	78,0	78,0
d	64,0	74,0	64,0	45,0	45,0	45,0	45,0
ø e	5,5	4,3	5,5	5,5	5,5	5,5	5,5
f	12,0	12,0	29,0	29,0	29,0	29,0	29,0
g	80,0	88,0	111,0	123,0	123,0	123,0	123,0
h	133,0	152,0	134,0	147,0	147,0	148,0	148,0
i	-	-	10,0	13,0	13,0	13,0	13,0
Cond. mm² min	1	1	1	2,5	2,5	2,5	2,5
Cond. mm² max	2,5	2,5	2,5	6	6	6	6

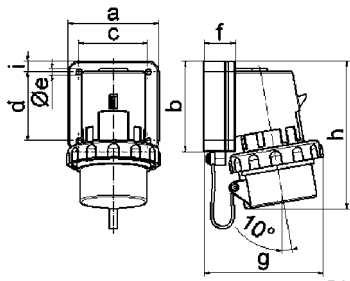

5 MB 3

Appliance Inlet with Flange QUICK-CONNECT TE

- Screwless terminals
- 10° angled
- High-temperature-resistant contact carrier
- Nickel plated contacts
- Protection degree IP44

QUICK-CONNECT

Ampere	Poles	110V 50-60 Hz	230V 50-60 Hz	400V 50-60 Hz	500V 50-60 Hz	>50V 100-300Hz	>50V 301-500Hz	Quantity	Each
		3pol 4pol 5pol 4h 4h 4h	3pol 4pol 5pol 6h 9h 9h	3pol 4pol 5pol 9h 6h 6h	3pol 4pol 5pol 7h 7h 7h	3pol 4pol 5pol 10h 10h 10h	3pol 4pol 5pol 2h 2h 2h		
16	3	27209	27121	27210				10	140
16	4	27211	27207	27122				10	215
16	5	27215	27216	27124				10	240
32	3	27218	27219	27220				10	275
32	4	27221	27222	27223				10	250
32	5	27247	27248	27249				10	315



27124

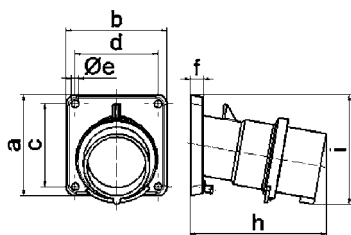

5 MB 21

Ampere	16	16	16	32	32	32
Poles	3	4	5	3	4	5
a	85,0	85,0	85,0	85,0	85,0	85,0
b	85,0	85,0	85,0	85,0	85,0	85,0
c	70,0	70,0	70,0	70,0	70,0	70,0
d	70,0	70,0	70,0	70,0	70,0	70,0
ø e	6,3	6,3	6,3	6,3	6,3	6,3
f	11,0	11,0	11,0	11,0	11,0	11,0
h	104,0	110,0	116,0	121,0	121,0	127,0
i	83,0	90,0	92,0	96,0	96,0	100,0
Cond. mm² min	1	1	1	2,5	2,5	2,5
Cond. mm² max	2,5	2,5	2,5	6	6	6

Appliance Inlet with Flange TE

- Screw terminals
- 10° angled
- Box terminals
- High-temperature-resistant contact carrier
- Nickel plated contacts
- Protection degree IP44

Ampere	Poles	110V 50-60 Hz	230V 50-60 Hz	400V 50-60 Hz	500V 50-60 Hz	>50V 100-300Hz	>50V 301-500Hz	Quantity	Each
		3pol 4pol 5pol 4h 4h 4h	3pol 4pol 5pol 6h 9h 9h	3pol 4pol 5pol 9h 6h 6h	3pol 4pol 5pol 7h 7h 7h	3pol 4pol 5pol 10h 10h 10h	3pol 4pol 5pol 2h 2h 2h		
63	3	2770	2771	2772				5	550
63	4	2773	2774	2775				5	570
63	5	2779	2780	2781				5	625



2781

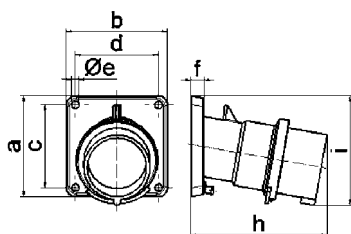

5 MB 21

Ampere	63	63	63
Poles	3	4	5
a	107,0	107,0	107,0
b	100,0	100,0	100,0
c	85,0	85,0	85,0
d	77,0	77,0	77,0
ø e	6,5	6,5	6,5
f	12,0	12,0	12,0
h	155,0	155,0	155,0
i	118,0	118,0	118,0
Cond. mm² min	6	6	6
Cond. mm² max	16	16	16

Appliance Inlet with Flange QUICK-CONNECT TE

- Screwless terminals
- 10° angled
- High-temperature-resistant contact carrier
- Nickel plated contacts
- Protection degree IP67

Accessories: closure cap, see page 108/3

QUICK-CONNECT



2793

Ampere	Poles	110V 50-60 Hz			230V 50-60 Hz			400V 50-60 Hz			500V 50-60 Hz			>50V 100-300Hz			>50V 301-500Hz			Quantity	Each
		3pol	4pol	5pol	3pol	4pol	5pol	3pol	4pol	5pol	3pol	4pol	5pol	3pol	4pol	5pol	2h	2h	2h		
16	3	27227			2783			27228											10	175	
16	4	27229			2786			2787											10	220	
16	5	27233			27234			2793											10	245	
32	3	27235			27236			27237											10	275	
32	4	27238			27239			27240											10	295	
32	5	27244			27245			27246											10	335	

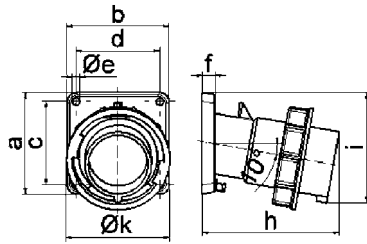

Ampere	Poles	16	16	16	32	32	32
a	3	85,0	85,0	85,0	85,0	85,0	85,0
b	4	85,0	85,0	85,0	85,0	85,0	85,0
c	5	70,0	70,0	70,0	70,0	70,0	70,0
d	3	70,0	70,0	70,0	70,0	70,0	70,0
ø e	3	6,3	6,3	6,3	6,3	6,3	6,3
f	3	11,0	11,0	11,0	11,0	11,0	11,0
h	3	104,0	110,0	116,0	121,0	121,0	127,0
i	3	83,0	90,0	92,0	96,0	96,0	100,0
k	3	70,5	79,5	86,5	95,0	95,0	101,5
Cond. mm² min		1	1	1	2,5	2,5	2,5
Cond. mm² max		2,5	2,5	2,5	6	6	6

5 MB 22

Appliance Inlet with Flange TE

- Screw terminals
- 10° angled
- Box terminals
- High-temperature-resistant contact carrier
- Nickel plated contacts
- Protection degree IP67

Accessories: closure cap, see page 108/3



27017

Ampere	Poles	110V 50-60 Hz			230V 50-60 Hz			400V 50-60 Hz			500V 50-60 Hz			>50V 100-300Hz			>50V 301-500Hz			Quantity	Each
		3pol	4pol	5pol	3pol	4pol	5pol	3pol	4pol	5pol	3pol	4pol	5pol	3pol	4pol	5pol	2h	2h	2h		
63	3	27006			27007			27008											5	575	
63	4	27009			27010			27011											5	640	
63	5	27015			27016			27017											5	695	

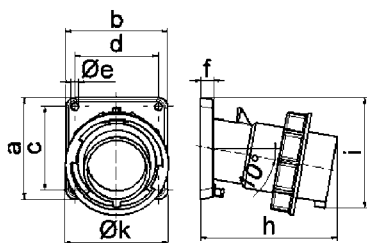

Ampere	Poles	63	63	63
a	3	107,0	107,0	107,0
b	4	100,0	100,0	100,0
c	5	85,0	85,0	85,0
d	3	77,0	77,0	77,0
ø e	3	6,5	6,5	6,5
f	3	12,0	12,0	12,0
h	3	155,0	155,0	155,0
i	3	118,0	118,0	118,0
k	3	113,5	113,5	113,5
Cond. mm² min		6	6	6
Cond. mm² max		16	16	16

5 MB 22

Appliance Inlet with Flange TE

- Screw terminals
- 10° angled
- Box terminals
- High-temperature-resistant contact carrier
- Nickel plated contacts
- Protection degree IP67

Accessories: closure cap, see page 108/3



2744

Ampere	Poles	110V 50-60 Hz			230V 50-60 Hz			400V 50-60 Hz			500V 50-60 Hz			>50V 100-300Hz			>50V 301-500Hz			Quantity	Each
		3pol	4pol	5pol	3pol	4pol	5pol	3pol	4pol	5pol	3pol	4pol	5pol	3pol	4pol	5pol	2h	2h	2h		
125	3	2735			2736			2737											5	905	
125	4	2738			2739			2740											5	1020	
125	5	2742			2743			2744											5	1115	

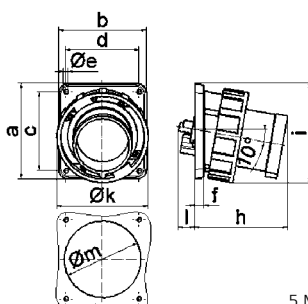

Ampere	Poles	125	125	125
a	3	130,0	130,0	130,0
b	4	120,0	120,0	120,0
c	5	108,0	108,0	108,0
d	3	100,0	100,0	100,0
ø e	3	6,5	6,5	6,5
f	3	13,0	13,0	13,0
h	3	130,0	130,0	130,0
i	3	135,0	135,0	135,0
k	3	126,0	126,0	126,0
l	3	23,0	23,0	23,0
ø m	3	105,0	105,0	105,0
Cond. mm² min		16	16	16
Cond. mm² max		50	50	50

5 MB 56

Appliance Inlet with Flange QUICK-CONNECT

- Screwless terminals
- Flange 75 x 75 mm
- Protection degree IP44

A retaining device to match the hinged cover of the connector must be provided to ensure the latching feature

QUICK-CONNECT



282002

		110V 50-60 Hz	230V 50-60 Hz	400V 50-60 Hz	500V 50-60 Hz	>50V 100-300Hz	>50V 301-500Hz	Quantity	Each
3PHE Ampere	3PHE Poles	3pol 4pol 5pol 4h 4h 4h	3pol 4pol 5pol 6h 9h 9h	3pol 4pol 5pol 9h 6h 6h	3pol 4pol 5pol 7h 7h 7h	3pol 4pol 5pol 10h 10h 10h	3pol 4pol 5pol 2h 2h 2h		
16	3	28001	28111				28002	10	90
16	4	28003	28017	28112	28004		28005	10	105
16	5		28006	282001			28008	10	125
32	3	28009	28010					10	145
32	4		28011	28012	28013			10	165
32	5	28014	28015	282002				10	195

Ampere	16	16	16	32	32	32
Poles	3	4	5	3	4	5
a	75,0	75,0	75,0	75,0	75,0	75,0
b	75,0	75,0	75,0	75,0	75,0	75,0
c	60,0	60,0	60,0	60,0	60,0	60,0
d	60,0	60,0	60,0	60,0	60,0	60,0
ø e	5,5	5,5	5,5	5,5	5,5	5,5
f	7,0	7,0	7,0	7,0	7,0	7,0
h	43,0	43,0	43,0	53,0	53,0	53,0
i	39,0	39,0	39,0	43,0	43,0	43,0
ø k	42,0	48,0	61,0	57,0	57,0	60,0
l	-	-	5,0	2,0	2,0	-
m	30,0	30,0	25,0	28,0	28,0	30,0
Cond. mm² min	1	1	1	2,5	2,5	2,5
Cond. mm² max	2,5	2,5	2,5	6	6	6

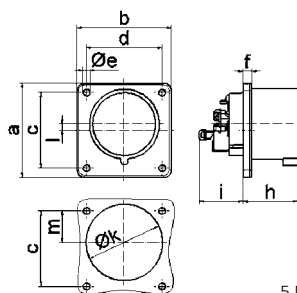

5 MB 85

Appliance Inlet with Flange

- Screw terminals
- Protection degree IP44

A retaining device to match the hinged cover of the connector must be provided to ensure the latching feature



28108

		110V 50-60 Hz	230V 50-60 Hz	400V 50-60 Hz	500V 50-60 Hz	>50V 100-300Hz	>50V 301-500Hz	Quantity	Each
3PHE Ampere	3PHE Poles	3pol 4pol 5pol 4h 4h 4h	3pol 4pol 5pol 6h 9h 9h	3pol 4pol 5pol 9h 6h 6h	3pol 4pol 5pol 7h 7h 7h	3pol 4pol 5pol 10h 10h 10h	3pol 4pol 5pol 2h 2h 2h		
16	3		2898					10	155
16	4			28100				10	170
16	5			28102				10	185
32	3		28104					10	
32	4			28106				10	
32	5			28108				10	240

Ampere	16	16	16	32	32	32
Poles	3	4	5	3	4	5
a	85,0	85,0	85,0	85,0	85,0	85,0
b	85,0	85,0	85,0	85,0	85,0	85,0
c	70,0	70,0	70,0	70,0	70,0	70,0
d	70,0	70,0	70,0	70,0	70,0	70,0
ø e	6,3	6,3	6,3	6,3	6,3	6,3
f	11,0	11,0	11,0	11,0	11,0	11,0
h	75,5	75,0	76,5	85,0	85,0	85,0
ø l	49,0	49,0	49,0	49,0	49,0	49,0
Cond. mm² min	1	1	1	2,5	2,5	2,5
Cond. mm² max	2,5	2,5	2,5	6	6	6

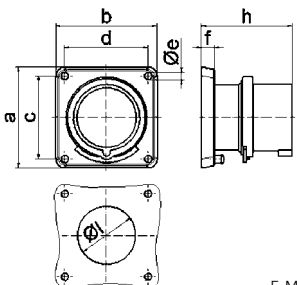

5 MB 126

Appliance Inlet with Flange

- Screw terminals
- Box terminals
- High-temperature-resistant contact carrier
- Nickel plated contacts
- Protection degree IP44

A retaining device to match the hinged cover of the connector must be provided to ensure the latching feature



2837

		110V 50-60 Hz	230V 50-60 Hz	400V 50-60 Hz	500V 50-60 Hz	>50V 100-300Hz	>50V 301-500Hz	Quantity	Each
3PHE Ampere	3PHE Poles	3pol 4pol 5pol 4h 4h 4h	3pol 4pol 5pol 6h 9h 9h	3pol 4pol 5pol 9h 6h 6h	3pol 4pol 5pol 7h 7h 7h	3pol 4pol 5pol 10h 10h 10h	3pol 4pol 5pol 2h 2h 2h		
63	3	2880	2834			2869		5	465
63	4		2841	2833	2864			5	530
63	5			2837	2858			5	580

Ampere	63	63	63
Poles	3	4	5
a	110,0	110,0	110,0
b	106,0	106,0	106,0
c	90,0	90,0	90,0
d	90,0	90,0	90,0
ø e	5,5	5,5	5,5
f	13,0	13,0	13,0
h	99,0	99,0	99,0
i	19,0	19,0	19,0
k	93,0	93,0	93,0
Cond. mm² min	6	6	6
Cond. mm² max	16	16	16

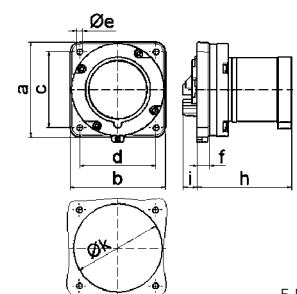

5 MB 59

Appliance Inlet with Flange

- Screw terminals
- High-temperature-resistant contact carrier
- Nickel plated contacts
- Protection degree IP67

A retaining device to match the hinged cover of the connector must be provided to ensure the latching feature

Accessories: closure cap, see page 108/3



28109

Ampere	Poles	110V 50-60 Hz			230V 50-60 Hz			400V 50-60 Hz			500V 50-60 Hz			>50V 100-300Hz			>50V 301-500Hz			Quantity	Each
		3pol	4pol	5pol	3pol	4pol	5pol	3pol	4pol	5pol	3pol	4pol	5pol	3pol	4pol	5pol	3pol	4pol	5pol		
16	3	2899															10	180			
16	4	28101															10	200			
16	5	28103															10	220			
32	3	28105															10	250			
32	4	28107															10	270			
32	5	28109															10	300			

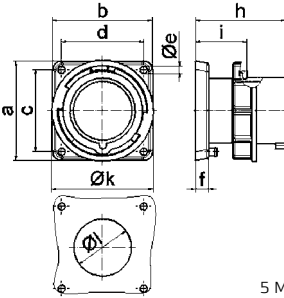

5 MB 124

Ampere Poles	16 3	16 4	16 5	32 3	32 4	32 5
a	85,0	85,0	85,0	85,0	85,0	85,0
b	85,0	85,0	85,0	85,0	85,0	85,0
c	70,0	70,0	70,0	70,0	70,0	70,0
d	70,0	70,0	70,0	70,0	70,0	70,0
ø e	6,3	6,3	6,3	6,3	6,3	6,3
f	11,0	11,0	11,0	11,0	11,0	11,0
h	75,5	75,0	76,5	85,0	85,0	85,0
i	44,0	44,0	44,0	44,0	44,0	44,0
k	70,5	78,5	86,5	94,0	94,0	101,5
ø l	49,0	49,0	49,0	49,0	49,0	49,0
Cond. mm² min	1	1	1	2,5	2,5	2,5
Cond. mm² max	2,5	2,5	2,5	6	6	6

Appliance Inlet with Flange TE

- Screw terminals
- Box terminals
- High-temperature-resistant contact carrier
- Nickel plated contacts
- Protection degree IP67

A retaining device to match the hinged cover of the connector must be provided to ensure the latching feature

Accessories: closure cap, see page 108/3



2838

Ampere	Poles	110V 50-60 Hz			230V 50-60 Hz			400V 50-60 Hz			500V 50-60 Hz			>50V 100-300Hz			>50V 301-500Hz			Quantity	Each
		3pol	4pol	5pol	3pol	4pol	5pol	3pol	4pol	5pol	3pol	4pol	5pol	3pol	4pol	5pol					
63	3	2881															5	530			
63	4	2842															5	580			
63	5	2838															5	650			

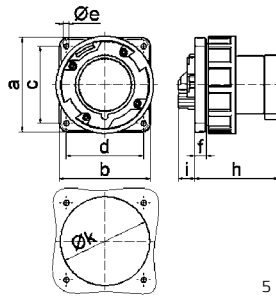

5 MB 50

Ampere Poles	63 3	63 4	63 5
a	110,0	110,0	110,0
b	106,0	106,0	106,0
c	90,0	90,0	90,0
d	90,0	90,0	90,0
ø e	5,5	5,5	5,5
f	13,0	13,0	13,0
h	99,0	99,0	99,0
i	19,0	19,0	19,0
k	93,0	93,0	93,0
Cond. mm² min	6	6	6
Cond. mm² max	16	16	16

Appliance Inlet with Flange TE

- Screw terminals
- Flange 120 x 120 mm
- Box terminals
- High-temperature-resistant contact carrier
- Nickel plated contacts
- Protection degree IP67

A retaining device to match the hinged cover of the connector must be provided to ensure the latching feature

Accessories: closure cap, see page 108/3



2876

Ampere	Poles	110V 50-60 Hz			230V 50-60 Hz			400V 50-60 Hz			500V 50-60 Hz			>50V 100-300Hz			>50V 301-500Hz			Quantity	Each
		3pol	4pol	5pol	3pol	4pol	5pol	3pol	4pol	5pol	3pol	4pol	5pol	3pol	4pol	5pol					
125	3	2882															5	885			
125	4	2860															5	950			
125	5	2861															5	1110			

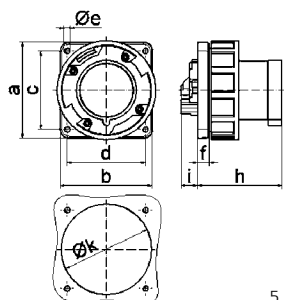

5 MB 57

Ampere Poles	125 3	125 4	125 5
a	120,0	120,0	120,0
b	120,0	120,0	120,0
c	100,0	100,0	100,0
d	100,0	100,0	100,0
ø e	6,5	6,5	6,5
f	13,0	13,0	13,0
h	116,0	116,0	116,0
i	20,0	20,0	20,0
k	104,0	104,0	104,0
Cond. mm² min	16	16	16
Cond. mm² max	50	50	50

Technical Information

- IEC 60309-1/2, EN 60309, VDE 0623
- Particularly suitable for harsh operating conditions, especially resistant to aggressive atmospheres

Appliance Inlet with Flange QUICK-CONNECT TE

- Screwless terminals
- 10° angled
- High-temperature-resistant contact carrier
- Nickel plated contacts
- Protection degree IP44

Dimension drawing: see page 97/1 (5 MB 21)

QUICK-CONNECT

27249



Amperage	Poles	230V 50-60 Hz			400V 50-60 Hz			500V 50-60 Hz			Quantity	Each
		3pol 6h	4pol 9h	5pol 9h	3pol 9h	4pol 6h	5pol 6h	3pol 7h	4pol 7h	5pol 7h		
16	3				27121	27210				10	140	
16	4				27207	27122	27212			10	215	
16	5				27216	27124	27217			10	240	
32	3				27219	27220				10	275	
32	4				27222	27223	27224			10	250	
32	5				27248	27249				10	315	

Appliance Inlet with Flange TE

- Screw terminals
- 10° angled
- High-temperature-resistant contact carrier
- Box terminals
- Nickel plated contacts
- Protection degree IP44

Dimension drawing: see page 97/2 (5 MB 21)

2781



Amperage	Poles	230V 50-60 Hz			400V 50-60 Hz			500V 50-60 Hz			Quantity	Each
		3pol 6h	4pol 9h	5pol 9h	3pol 9h	4pol 6h	5pol 6h	3pol 7h	4pol 7h	5pol 7h		
63	3				2771	2772				5	515	
63	4				2774	2775	2776			5	570	
63	5				2780	2781				5	625	

Appliance Inlet with Flange TE

- Screwless terminals
- 10° angled
- High-temperature-resistant contact carrier
- Nickel plated contacts
- Protection degree IP67

Accessories: closure cap, see page 108/3
Dimension drawing: see page 98/1 (5 MB 22)

QUICK-CONNECT

27246

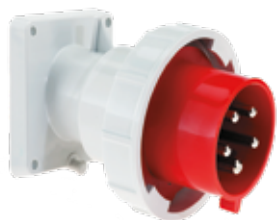

Amperage	Poles	230V 50-60 Hz			400V 50-60 Hz			500V 50-60 Hz			Quantity	Each
		3pol 6h	4pol 9h	5pol 9h	3pol 9h	4pol 6h	5pol 6h	3pol 7h	4pol 7h	5pol 7h		
16	3				2783	27228				10	175	
16	4				2786	2787	27230			10	220	
16	5				27234	2793	27278			10	245	
32	3				27236	27237				10	275	
32	4				27239	27240	27241			10	295	
32	5				27245	27246				10	335	

Appliance Inlet with Flange TE

- Screw terminals
- 10° angled
- High-temperature-resistant contact carrier
- Box terminals
- Nickel plated contacts
- Protection degree IP67

Accessories: closure cap, see page 102/3
Dimension drawing: see page 98/2 (5 MB 22)

27017



Amperage	Poles	230V 50-60 Hz			400V 50-60 Hz			500V 50-60 Hz			Quantity	Each
		3pol 6h	4pol 9h	5pol 9h	3pol 9h	4pol 6h	5pol 6h	3pol 7h	4pol 7h	5pol 7h		
63	3				27007	27008				5	575	
63	4				27010	27011	27012			5	640	
63	5				27016	27017				5	695	

Appliance Inlet with Flange TE

- Screw terminals
- 10° angled
- High-temperature-resistant contact carrier
- Box terminals
- Nickel plated contacts
- Protection degree IP67

A retaining device to match the hinged cover of the connector must be provided to ensure the latching feature

Accessories: closure cap, see page 108/3
Dimension drawing: see page 98/3 (5 MB 56)

2744



Amperage	Poles	230V 50-60 Hz			400V 50-60 Hz			500V 50-60 Hz			Quantity	Each
		3pol 6h	4pol 9h	5pol 9h	3pol 9h	4pol 6h	5pol 6h	3pol 7h	4pol 7h	5pol 7h		
125	3				2736	2737				5	905	
125	4				2739	2740	2741			5	1020	
125	5				2743	2744	27024			5	1115	

**Phase Inverter as Plug
QUICK-CONNECT with MULTI-GRIP**

- Screwless terminals
- Screwless enclosure connection, self locking
- Special gland, simultaneous cable gland and seal
- Protection degree IP44

Dimension drawing: see page 84/1 (2 MB 99)

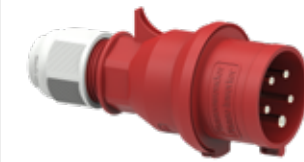

225

Amperage	Poles	230V 50-60 Hz			400V 50-60 Hz			Quantity	Each
		3pol 6h	4pol 9h	5pol 9h	3pol 9h	4pol 6h	5pol 6h		
16	4		22052				10	135	
16	5		224				10	160	
32	4		22054				10	250	
32	5						10	260	

**Phase Inverter as Plug TE
with MULTI-GRIP**

- Screw terminals
- Special gland, simultaneous cable gland and seal
- High-temperature-resistant contact carrier
- Nickel plated contacts
- Protection degree IP44

Dimension drawing: see page 84/2 (2 MB 93)



2271

Amperage	Poles	230V 50-60 Hz			400V 50-60 Hz			Quantity	Each
		3pol 6h	4pol 9h	5pol 9h	3pol 9h	4pol 6h	5pol 6h		
16	5						10	195	
32	5						10	300	

**Phase Inverter as Plug TE
with MULTI-GRIP**

- Screw terminals
- Special gland, simultaneous cable gland and seal
- High-temperature-resistant contact carrier
- Nickel plated contacts
- Protection degree IP67

Accessories: closure cap page 108/3
Dimension drawing: see page 85/1 (2 MB 94)



2251



Amperage	Poles	230V 50-60 Hz			400V 50-60 Hz			Quantity	Each
		3pol 6h	4pol 9h	5pol 9h	3pol 9h	4pol 6h	5pol 6h		
16	5						10	230	
32	5						10	360	

**Phase Inverter as
Surface Mounting Appliance Inlet**

- Screw terminals
- High-temperature-resistant contact carrier
- Nickel plated contacts
- Protection degree IP44

Dimension drawing: see page 88/1 (5 MB 45)

24211



Amperage	Poles	230V 50-60 Hz			400V 50-60 Hz			Quantity	Each
		3pol 6h	4pol 9h	5pol 9h	3pol 9h	4pol 6h	5pol 6h		
16	5						10	320	
32	5						10	380	

**Phase Inverter as
Panel Mounting Appliance Inlet**

- Screw terminals
- Nickel plated contacts
- Protection degree IP44

Dimension drawing: see page 93/1 (5 MB 92)

2602



Amperage	Poles	230V 50-60 Hz			400V 50-60 Hz			Quantity	Each
		3pol 6h	4pol 9h	5pol 9h	3pol 9h	4pol 6h	5pol 6h		
16	5						10	185	
32	5						10	250	

Phase Inverter as Panel Mounting Appliance Inlet

- Screw terminals
- With hinged lid
- Nickel plated contacts
- Protection degree IP44

Dimension drawing: see page 93/2 (5 MB 93)



26020

Amperes	Poles	230V 50-60 Hz			400V 50-60 Hz			Quantity	Each
		3pol 6h	4pol 9h	5pol 9h	3pol 9h	4pol 6h	5pol 6h		
16	5						10	270	
32	5						10	345	
		26020							
		26020							

Phase Inverter as Appliance Inlet with Flange

- Screw terminals
- Nickel plated contacts
- Protection degree IP44

A retaining device to match the hinged cover of the connector must be provided to ensure the latching feature

Dimension drawing: see page 99/2 (5 MB 126)



28183

Amperes	Poles	230V 50-60 Hz			400V 50-60 Hz			Quantity	Each
		3pol 6h	4pol 9h	5pol 9h	3pol 9h	4pol 6h	5pol 6h		
16	5						10	205	
32	5						10	275	
		28181							
		28183							

Phase Inverter as Appliance Inlet with Flange

- Screw terminals
- Nickel plated contacts
- High-temperature-resistant contact carrier
- Protection degree IP44

A retaining device to match the hinged cover of the connector must be provided to ensure the latching feature

Dimension drawing: see page 99/1 (5 MB 85)



2870

Amperes	Poles	230V 50-60 Hz			400V 50-60 Hz			Quantity	Each
		3pol 6h	4pol 9h	5pol 9h	3pol 9h	4pol 6h	5pol 6h		
16	5						10	140	
32	5						10	195	
		2870							
		2870							

Phase Inverter as Panel Mounting Appliance Inlet

- Screw terminals
- High-temperature-resistant contact carrier
- Nickel plated contacts
- Protection degree IP67

Accessories: closure cap, see page 108/3
Dimension drawing: see page 96/1 (5 MB 1)



2607

Amperes	Poles	230V 50-60 Hz			400V 50-60 Hz			Quantity	Each
		3pol 6h	4pol 9h	5pol 9h	3pol 9h	4pol 6h	5pol 6h		
16	5						10	205	
32	5						10	285	
		26009			2607				
		26010			2608				

Phase Inverter as Appliance Inlet with Flange

- Screw terminals
- Nickel plated contacts
- Protection degree IP67

A retaining device to match the hinged cover of the connector must be provided to ensure the latching feature

Accessories: closure cap, see page 108/3
Dimension drawing: see page 100/1 (5 MB 124)



28184

Amperes	Poles	230V 50-60 Hz			400V 50-60 Hz			Quantity	Each
		3pol 6h	4pol 9h	5pol 9h	3pol 9h	4pol 6h	5pol 6h		
16	5						10	250	
32	5						10	310	
		28182							
		28184							

Technical Information

- IEC 60309, EN 60309, VDE 0623
- Only suitable for short time service!

Phase Sequence Indicator

- Nickel plated contacts

Phase sequence indicators for reefer container, see page 210/5



2214

Amperes	Poles	230V 50-60 Hz	400V 50-60 Hz	500V 50-60 Hz	Quantity	Each
		3pol 6h 4pol 9h 5pol 9h	3pol 9h 4pol 6h 5pol 6h	3pol 7h 4pol 7h 5pol 7h		
16	5	2213	2214	2215	10	175
32	4	2216	2217	2218	10	245
32	5	2219	2220	2221	10	250
63	4	2222	2223	2224	2	475
63	5	2225	2226	2227	2	525

Phase Sequence Indicator "TRIPOL" 400/ 230V

- Nickel plated contacts
- With integrated Domestic socket (type F - German standard)
- Integrated electronics for:
a) rotary field indicator
b) connection of testing devices
c) phase sequence indicator



2235

Amperes	Poles	230V 50-60 Hz	400V 50-60 Hz	500V 50-60 Hz	Quantity	Each
		3pol 6h 4pol 9h 5pol 9h	3pol 9h 4pol 6h 5pol 6h	3pol 7h 4pol 7h 5pol 7h		
16	5		2234		10	240
32	5		2235		5	310
63	5		2236		2	610

Phase Sequence Indicator

- Nickel plated contacts
- Without keyway
- For all operating voltages between 230V and 600V



2231

Amperes	Poles				Quantity	Each
		3pol 9h	4pol 6h	5pol 6h		
16	5			2229	10	175
32	4			2230	10	245
32	5			2231	10	250
63	4			2232	2	475
63	5			2233	1	525

Adapter Plug

Further adapter systems on request.



8615

	Ref. no.
CEE plug 16A/ 230V/ 3p to Domestic socket 16A/ 230V~ type F - German standard	8615
CEE plug 16A/ 230V/ 3p to domestic socket 16A/ 230V ~, type E Belgian/French standard	8614
CEE plug 16A/ 230V/ 3p to domestic socket 16A/ 230V ~, type J Swiss standard	8618

Adapter Plug

Further adapter systems on request.



860

	Ref. no.
CEE plug 16A/ 400V/ 5p to Domestic socket 16A/ 230V~ type F - German standard	860

Connector QUICK-CONNECT with MULTI-GRIP

- Screwless terminals
- Screwless enclosure connection, self locking
- Kontex contact
- Special gland, simultaneous cable gland and seal
- Protection degree IP44

QUICK-CONNECT
MULTI-GRIP



3148

Ampere	Poles	110V 50-60 Hz	230V 50-60 Hz	400V 50-60 Hz	500V 50-60 Hz	>50V 100-300Hz	>50V 301-500Hz	Quantity	Each
		3pol 4pol 5pol 4h 4h 4h	3pol 4pol 5pol 6h 9h 9h	3pol 4pol 5pol 9h 6h 6h	3pol 4pol 5pol 7h 7h 7h	3pol 4pol 5pol 10h 10h 10h	3pol 4pol 5pol 2h 2h 2h		
16	3	3125	3126					10	120
16	4		3129	3130				10	160
16	5		3135	3136				10	165
32	3	3137	3138					10	240
32	4		3141	3142				10	260
32	5		3147	3148				10	300

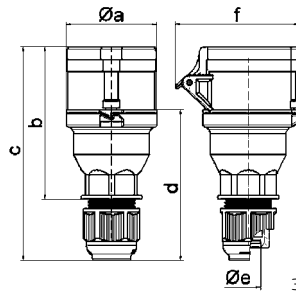

Ampere	16	16	16	32	32	32
Poles	3	4	5	3	4	5
Ø a	53,0	60,0	66,0	74,5	74,5	74,5
b	100,5	112,5	113,5	133,5	133,5	134,5
c	141,0	153,0	154,0	186,0	186,0	187,0
d	97,5	104,5	105,5	127,5	127,5	128,5
Ø e	18,0	18,0	18,0	23,0	23,0	23,0
f	76,0	79,0	86,0	92,0	92,0	97,0
Cond. mm² min	1	1	1	2,5	2,5	2,5
Cond. mm² max	2,5	2,5	2,5	6	6	6

3 MB 65

Connector TE-Plus with MULTI-GRIP

- Screwless terminals
- High-temperature-resistant contact carrier
- Kontex contact
- Nickel plated contacts
- Special gland, simultaneous cable gland and seal
- Protection degree IP44

QUICK-CONNECT
MULTI-GRIP



31981

Ampere	Poles	110V 50-60 Hz	230V 50-60 Hz	400V 50-60 Hz	500V 50-60 Hz	>50V 100-300Hz	>50V 301-500Hz	Quantity	Each
		3pol 4pol 5pol 4h 4h 4h	3pol 4pol 5pol 6h 9h 9h	3pol 4pol 5pol 9h 6h 6h	3pol 4pol 5pol 7h 7h 7h	3pol 4pol 5pol 10h 10h 10h	3pol 4pol 5pol 2h 2h 2h		
16	3	31659	31533	31665	31955	31956	31957	10	145
16	4	31681	31661	31534	31959	31669	31671	10	170
16	5	31962	31662	31536	31964	31965	31966	10	200
32	3	31967	31968	31666	31970	31971	31972	10	265
32	4	31973	31974	31975	31976	31670	31672	10	285
32	5	31979	31664	31981	31884	31983	31984	10	340

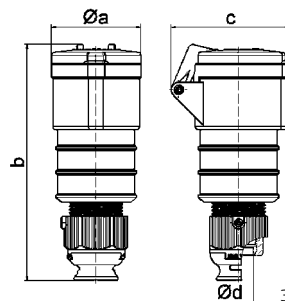

Ampere	16	16	16	32	32	32
Poles	3	4	5	3	4	5
Ø a	51,0	58,0	65,0	66,5	66,5	72,0
b	156,0	162,0	168,0	195,0	195,0	198,0
c	72,0	78,0	86,0	89,0	89,0	99,0
Ø d	18,0	18,0	21,0	23,0	23,0	27,0
Cond. mm² min	1	1	1	2,5	2,5	2,5
Cond. mm² max	2,5	2,5	2,5	6	6	6

3 MB 62

Connector TE with MULTI-GRIP

- High-temperature-resistant contact carrier
- Kontex contact
- Nickel plated contacts
- Special gland, simultaneous cable gland and seal
- Protection degree IP44

MULTI-GRIP



3112

Ampere	Poles	110V 50-60 Hz	230V 50-60 Hz	400V 50-60 Hz	500V 50-60 Hz	>50V 100-300Hz	>50V 301-500Hz	Quantity	Each
		3pol 4pol 5pol 4h 4h 4h	3pol 4pol 5pol 6h 9h 9h	3pol 4pol 5pol 9h 6h 6h	3pol 4pol 5pol 7h 7h 7h	3pol 4pol 5pol 10h 10h 10h	3pol 4pol 5pol 2h 2h 2h		
63	4			310490	310492			5	740
63	5			310494				5	785
Screw terminal:									
63	3	3108	3104	3109	31723	31606	31858	5	590
63	4	3149	3150	3151	3152	31085	31642	5	630
63	5	3153	3154	3112	31086	31500	31257	5	670

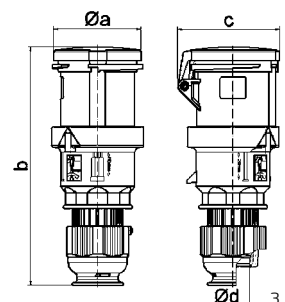

Ampere	63	63	63
Poles	3	4	5
Ø a	95,0	95,0	95,0
b	251,0	251,0	251,0
c	109,0	109,0	109,0
Ø d	36,0	36,0	36,0
Cond. mm² min	6	6	6
Cond. mm² max	16	16	16

3 MB 107

Connector with MULTI-GRIP

- Screw terminals
- Nickel plated contacts
- One-piece enclosure
- Kontex contact
- Special gland, simultaneous cable gland and seal
- Protection degree IP67

MULTI-GRIP



310346

Ampere	Polzahl	110V 50-60 Hz	230V 50-60 Hz	400V 50-60 Hz	500V 50-60 Hz	>50V 100-300Hz	>50V 301-500Hz	Quantity	Each
		3pol 4pol 5pol 4h 4h 4h	3pol 4pol 5pol 6h 9h 9h	3pol 4pol 5pol 9h 6h 6h	3pol 4pol 5pol 7h 7h 7h	3pol 4pol 5pol 10h 10h 10h	3pol 4pol 5pol 2h 2h 2h		
16	3	310331	310333	310334				10	175
16	4	310338	310339	310340				10	200
16	5	310344	310345	310346				10	220
32	3	310350	310351	310352				10	305
32	4	310356	310357	310358				10	315
32	5	310362	310363	310364				10	380

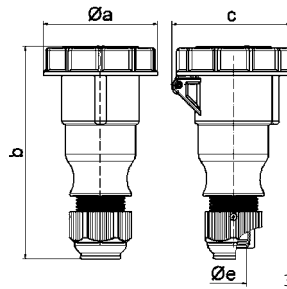

Ampere	16	16	16	32	32	32
Polzahl	3	4	5	3	4	5
ø a	70,5	78,0	86,5	94,0	94,0	101,5
b	154,0	155,0	160,0	190,0	190,0	190,0
c	77,0	83,0	93,0	99,0	99,0	107,0
ø e	18,0	18,0	18,0	23,0	23,0	23,0
Cond. mm² min	1	1	1	2,5	2,5	2,5
Cond. mm² max	2,5	2,5	2,5	6	6	6

3 MB 81

Connector TE-Plus with MULTI-GRIP

- Screwless terminals
- High-temperature-resistant contact carrier
- Kontex contact
- Nickel plated contacts
- Special gland, simultaneous cable gland and seal
- Protection degree IP67

QUICK-CONNECT
MULTI-GRIP



31243

Ampere	Polzahl	110V 50-60 Hz	230V 50-60 Hz	400V 50-60 Hz	500V 50-60 Hz	>50V 100-300Hz	>50V 301-500Hz	Quantity	Each
		3pol 4pol 5pol 4h 4h 4h	3pol 4pol 5pol 6h 9h 9h	3pol 4pol 5pol 9h 6h 6h	3pol 4pol 5pol 7h 7h 7h	3pol 4pol 5pol 10h 10h 10h	3pol 4pol 5pol 2h 2h 2h		
16	3	31298	31240	31299	31457	310554	310417	10	175
16	4	31301	31302	31241	31242	31303	31304	10	205
16	5	31305	31306	31243	31501		31409	10	245
32	3	31307	31244	31308				10	335
32	4	31309	31310	31245	31246	31311	31312	10	350
32	5	31313	31314	31247	31207		310415	10	410

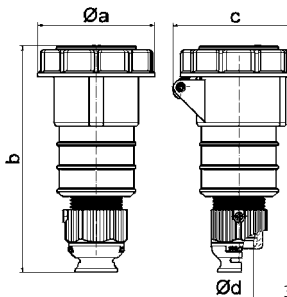

Ampere	16	16	16	32	32	32
Polzahl	3	4	5	3	4	5
ø a	70,5	78,0	86,5	94,0	94,0	101,5
b	161,0	161,0	168,0	196,0	196,0	200,0
c	77,0	83,0	93,0	99,0	99,0	107,0
ø d	18,0	18,0	21,0	23,0	23,0	27,0
Cond. mm² min	1	1	1	2,5	2,5	2,5
Cond. mm² max	2,5	2,5	2,5	6	6	6

3 MB 63

Connector TE-Plus with MULTI-GRIP

- High-temperature-resistant contact carrier
- Kontex contact
- Nickel plated contacts
- Special gland, simultaneous cable gland and seal
- Protection degree IP67

MULTI-GRIP



310495

Ampere	Polzahl	110V 50-60 Hz	230V 50-60 Hz	400V 50-60 Hz	500V 50-60 Hz	>50V 100-300Hz	>50V 301-500Hz	Quantity	Each
		3pol 4pol 5pol 4h 4h 4h	3pol 4pol 5pol 6h 9h 9h	3pol 4pol 5pol 9h 6h 6h	3pol 4pol 5pol 7h 7h 7h	3pol 4pol 5pol 10h 10h 10h	3pol 4pol 5pol 2h 2h 2h		
63	4			310491	310493			5	800
63	5			310495				5	855
Screw terminal:									
63	3	3180	3181	3182	31724	31605		5	665
63	4	3183	3184	3185	3186	31504	31251	5	720
63	5	3187	3188	3124	31082	31505	31183	5	720

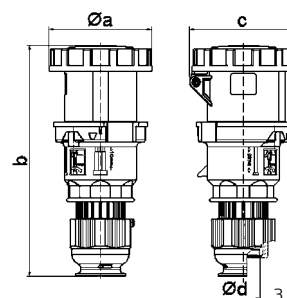

Ampere	63	63	63
Polzahl	3	4	5
ø a	110,0	110,0	110,0
b	251,0	251,0	251,0
c	113,0	113,0	113,0
ø d	36,0	36,0	36,0
Cond. mm² min	6	6	6
Cond. mm² max	16	16	16

3 MB 109

Connector TE with MULTI-GRIP

- Screw terminals
- Box terminals
- High-temperature-resistant contact carrier
- Kontex contact
- Nickel plated contacts
- Special gland, simultaneous cable gland and seal
- self locking
- Protection degree IP67

MULTI-GRIP



3199

Ampere	Poles	110V	230V	400V	500V	>50V	>50V	Quantity	Each
		50-60 Hz	50-60 Hz	50-60 Hz	50-60 Hz	100-300Hz	301-500Hz		
125	3	3190	3191	3192				5	1130
125	4	3193	3194	3195	3196	31611		5	1230
125	5	3197	3198	3199	31417			5	1300

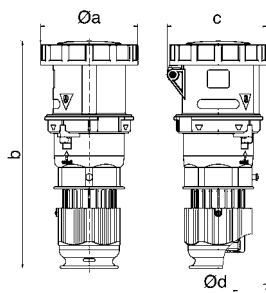

Ampere	125	125	125
Poles	3	4	5
ø a	125,0	125,0	125,0
b	295,0	295,0	295,0
c	128,0	128,0	128,0
ø d	50,0	50,0	50,0
Cond. mm² min	16	16	16
Cond. mm² max	50	50	50

Connector QUICK-CONNECT lockable

- Screwless terminals
- Lockable with matching connector
- Screwless enclosure connection, self locking
- Special gland, simultaneous cable gland and seal
- Protection degree IP44

Accessories: Lock set, see page 108/5

QUICK-CONNECT MULTI-GRIP



310635

Ampere	Poles	110V	230V	400V	500V	>50V	>50V	Quantity	Each
		50-60 Hz	50-60 Hz	50-60 Hz	50-60 Hz	100-300Hz	301-500Hz		
16	5			310634				10	190
32	5			310635				10	300

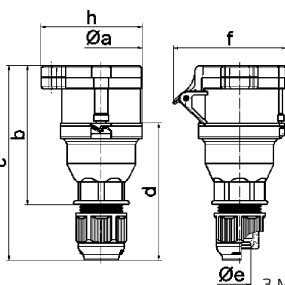

Ampere	16	32
Poles	5	5
ø a	66,0	74,5
b	113,5	134,5
c	154,0	187,0
d	105,5	128,5
ø e	18,0	23,0
f	86,0	97,0
h	82,0	100,0
Cond. mm² min	1	2,5
Cond. mm² max	2,5	6

Hanging Connector TE-Plus with MULTI-GRIP

- Screwless terminals
- High-temperature-resistant contact carrier
- Kontex contact
- Nickel plated contacts
- Special gland, simultaneous cable gland and seal
- Protection degree IP44

QUICK-CONNECT MULTI-GRIP



3214

Ampere	Poles	110V	230V	400V	500V	>50V	>50V	Quantity	Each
		50-60 Hz	50-60 Hz	50-60 Hz	50-60 Hz	100-300Hz	301-500Hz		
16	3	3208	3209					10	190
16	4			3210	3211	3213	3212	10	220
16	5			3214				10	260
32	3	3215	3216					10	
32	4			3217	3218	3220	3219	10	
32	5			3221				10	425

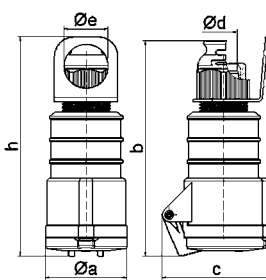

Ampere	16	16	16	32	32	32
Poles	3	4	5	3	4	5
ø a	51,0	58,0	65,0	66,5	66,5	72,0
b	156,0	162,0	168,0	195,0	195,0	198,0
c	72,0	78,0	86,0	89,0	89,0	99,0
ø d	18,0	18,0	21,0	23,0	23,0	27,0
ø e	39,5	39,5	35,5	48,5	48,5	44,5
h	167,5	173,5	171,5	208,0	208,0	205,0
Cond. mm² min	1	1	1	2,5	2,5	2,5
Cond. mm² max	2,5	2,5	2,5	6	6	6

Hanging Clip

- For plugs and connectors with MULTI-GRIP cable gland



58401

Ref. no.

for 16A	58400
for 32A	58401
for 63A and 125A	58402

Cable Gland Multi-Grip with Additional Strain Relief

- For plugs and connectors with MULTI-GRIP cable gland



29132

Ref. no.

for 16A / 3pol., 4pol. TE + TE-Plus + QC + TLS	29148
for 16A / 5pol. TE + TE-Plus	29149
for 32A / 5pol. TE + TE-Plus	29150
for 63A / 3pol., 4pol., 5pol. TE + TE-Plus	29132
for 125A / 3pol., 4pol., 5pol. TE	29133

Closure Cap

- For CEE plugs
- Protection degree IP67



832

Ref. no.

16A / 3pol.	830
16A / 4pol.	835
16A / 5pol., 7pol.	831
32A / 3pol., 4pol.	837
32A / 5pol., 7pol.	832
63A / 3pol., 4pol., 5pol.	833
125A / 3pol., 4pol., 5pol.	834

Reducer

- Suitable for cables less than Ø8mm
- For all 16A standard plugs and sockets with MULTI-GRIP as well as extra-low voltage



Ref. no.

29129

Lock Set

- For plugs/connectors of type 310634, 310635, 210950 and 210951
- With long shackle and 2 keys



Ref. no.

580642

1

2

3

4

5

6

7

8

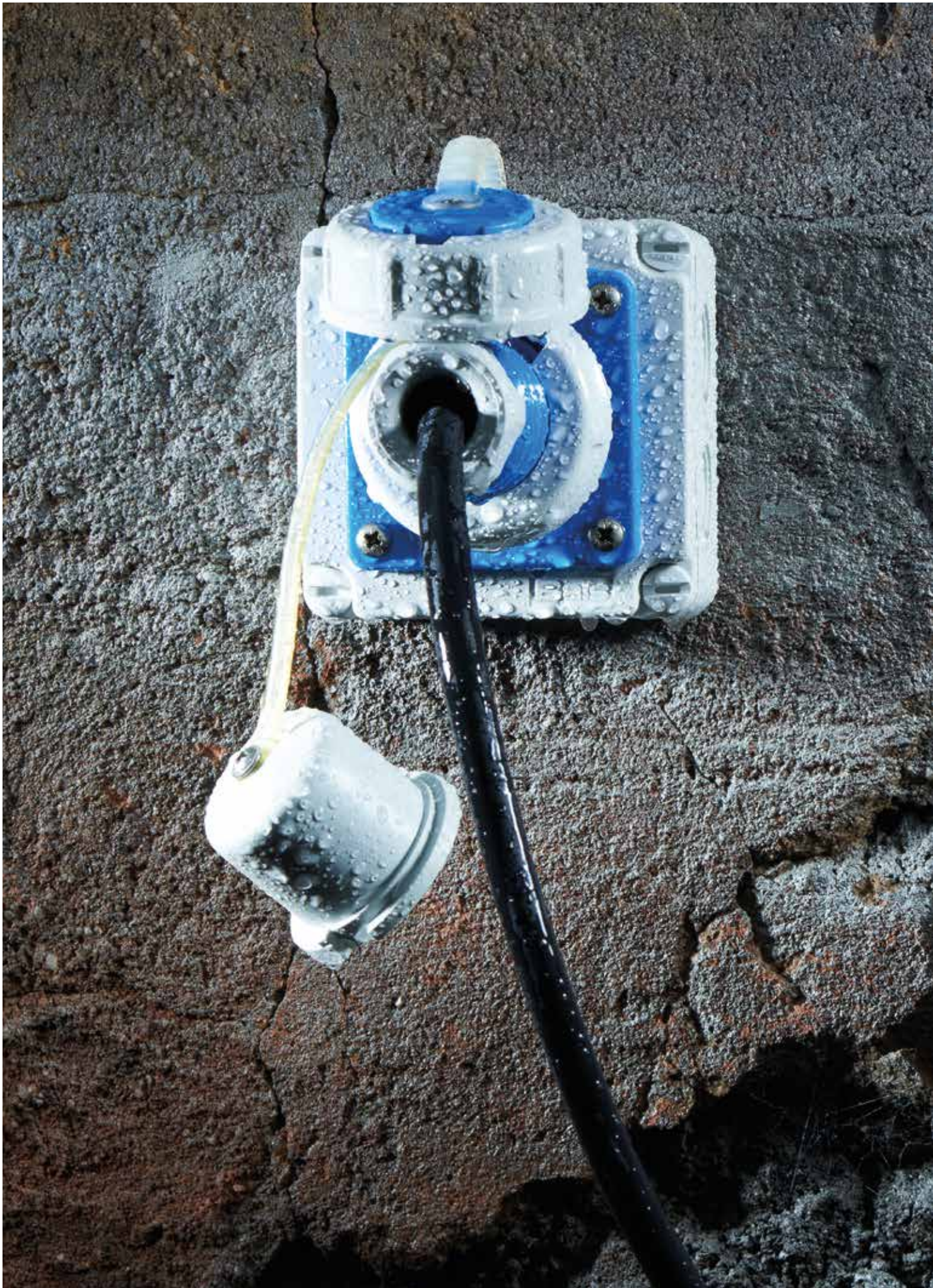



1

2

3

4

5

6

7

8

Domestic Panel Mounting Socket Outlets



Domestic Surface Mounting Socket Outlets



Domestic Plugs and Inlets



Domestic Connectors



Domestic Extension Leads



Technical features

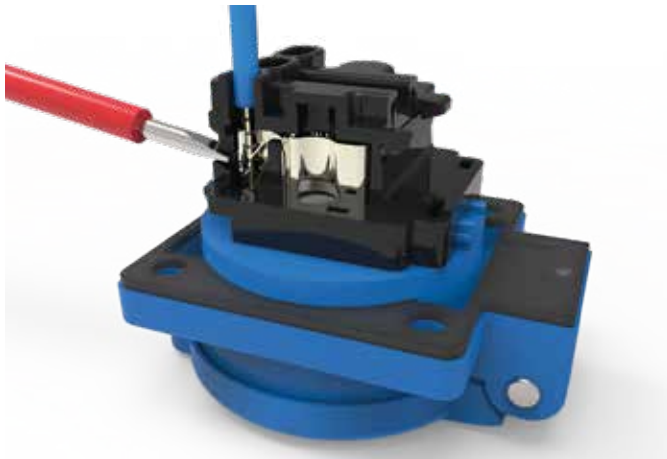

Domestic Panel Mounting Socket Outlets with QUICK CONNECT

- Screwless connection technology
- Robust terminal and enclosure design
- Special contact technology largely prevents contact deformation that can lead to a rise in temperature
- Flange dimensions in 50 x 50 mm and 75 x 75 mm
- Versions available for German, Swiss, or Belgian/French system



Domestic Panel Mounting Socket Outlets with QUICK CONNECT

- Captive flange seal
- Available as IP44 or IP54
- Also with shutter on request
- Special colours on request
- VDE tested
- Touch-safe in accordance with BGV A3
- Nickel plated contacts



Usable conductor configurations

- Required stripping length and pin length with cable lugs 10 to 12 mm
- Solid conductor 1,5 mm² to 2,5 mm²
- Flexible conductor 1,5 mm² to 2,5 mm² with cable end ferrules, gas-tight crimp
- Flexible conductor 1,5 mm² to 2,5 mm² ultrasonically welded



Domestic Surface Mounting Socket Outlet, switched, interlocked

- Switched and electrically interlocked
- Load-free connection and disconnection is guaranteed
- Surface Mounting Socket Outlet can be operated safely both with an IP44 Domestic plug and an IP67 Domestic plug
- Safe
- Simple operation
- Clear state detection owing to engraved ON/OFF position
- Lockable 3x in 0-position



1

2

3

4

5

6

7

8

The domestic plugs and connectors with a separated design and with the unique MULTI-GRIP cable gland. This integrated strain relief system invented by Bals, which has

proven itself for over 15 years, now makes installation even easier and, above all, safer in the area of domestic plugs and connectors.

MULTI-GRIP

- MULTI-GRIP cable gland with integrated strain relief and seal
- Optimal strain relief for small and large cable diameters
- No time-consuming mounting of additional internal strain relief
- The time-consuming adjustment of onion rings to the cable diameter is eliminated
- Quick and safe closing of the cable gland due to the double thread

- The rubber seal that is fixed to the housing is captive and provides a reliable seal
- The condition of the strain relief can be checked from the outside at any time

Plug

- Protection degree IP44
- Easy and quick installation due to separated design
- Spacious connection area
- The alignment of the connections is the same for all contacts and the connection screws can therefore all be operated from one direction
- The housing and connection screws can be screwed with one and the same tool
- Cross sections of 1 mm² to 4 mm² can be connected without problem
- Also suitable for Belgian/French standard (plugs)
- Different colour variants (blue, red, black and grey) available

Connector

- Like plugs but also:
- Optional with shutter
 - Also available in Belgian/French system
 - IP54



A spacious housing allows an uncomplicated installation.



Cross sections of 1 mm² to 4 mm² can be connected without problem.



The socket outlets with screwless QUICK-CONNECT connection technology are available as an IP54 version for fixed or mobile distributors that comply with DIN 49442. These are additionally equipped with an increased sealing lip in the plug-in area. A special contact technology and exclusively available for our products, largely prevents contact deformation, which can lead to contact pressure loss and thus to an increase in temperature.

These unique terminals are designed for cross sections from 1.5mm² to 2.5mm² for rigid or flexible conductors with ferrules. The sockets also have a captive flange gasket, which is also optionally available with shutter. The flange dimensions of 50x50 mm or 75x75 mm provide maximum flexibility and are available in German and Belgian / French systems.

- Screwless connection technology
- Robust terminal and housing design
- New, attractive design
- Special contact technology mostly prevents deformation ultimately leading to lessening contact pressure and subsequent higher temperatures
- Captive flange seal
- Available as IP44 or IP54 variant

- Flange dimensions in 50x50 mm and 75x75 mm
- Versions available for German, Swiss, or Belgian/French system
- Also with shutter on request
- Special colours on request (depending on quantity)
- VDE-tested
- Finger-proof in accordance with BGV A3
- Nickel plated contacts

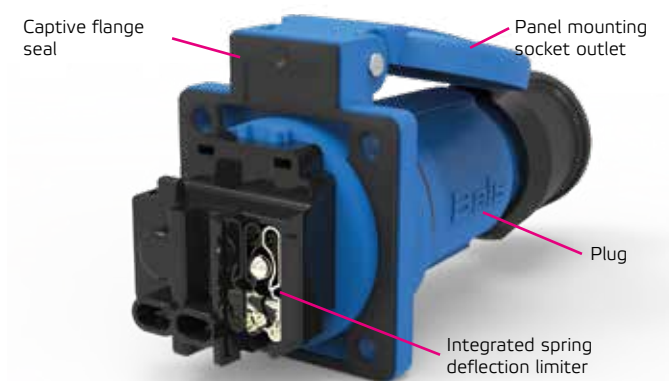

Solid design reduces contact deformation.



Simple disconnection of the conductor using a screwdriver.

Domestic Plugs and Sockets

German earthing system type F

Technical Information

- 16A / 250V~
- VDE 0620 / NBN C 61-112-1

Domestic Panel Mounting Socket Outlet

- Screw terminals
- Without hinged lid
- Connection at rear
- Nickel plated contacts
- Protection degree IP20

Type F - German standard



713

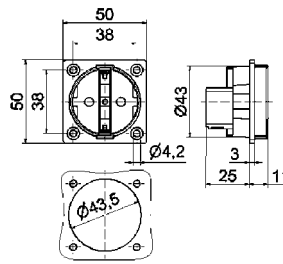

18 MB 1

Version	Colour	Order no.	Qty
Screw terminal	blue	713	20
Screw terminal	grey	712	20
Screw terminal	black	714	20

Domestic Panel Mounting Socket Outlet

- Hinged lid and injected flange gasket
- Flange 50 x 50 mm
- Mounting dimension 38 x 38 mm
- Connection terminal in accordance with BGV A2
- Nickel plated contacts
- Protection degree IP54

Type F - German standard



71099

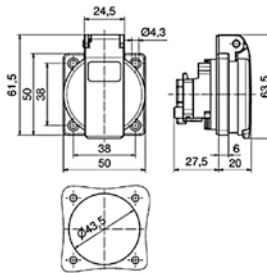

18 MB 102

Version	Colour	Order no.	Qty
QUICK CONNECT	blue	71099	20
QUICK CONNECT	grey	71100	20
QUICK CONNECT	black	71101	20
Screw terminal	blue	71094	20
Screw terminal	grey	71095	20
Screw terminal	black	71097	20

Domestic Panel Mounting Socket Outlet

- Flange 75 x 75 mm
- Mounting dimension 60 x 60 mm
- Nickel plated contacts
- Protection degree IP54

Type F - German standard



71108

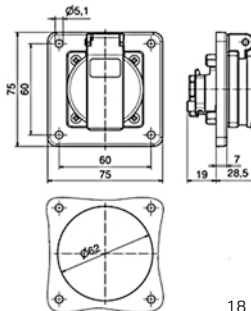

18 MB 107

Version	Colour	Order no.	Qty
QUICK CONNECT	blue	71108	20
QUICK CONNECT	grey	71109	20
QUICK CONNECT	black	71110	20
Screw terminal	blue	71105	20
Screw terminal	grey	71106	20
Screw terminal	black	71107	20

Domestic Panel Mounting Socket Outlet

- Screw terminals
- Flange 75 x 75 mm
- Mounting dimension 60 x 60 mm
- Nickel plated contacts
- Protection degree IP68

Type F - German standard



7112

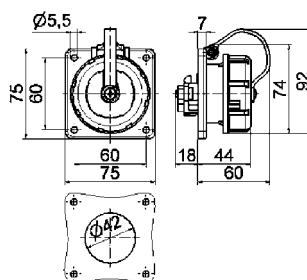

18 MB 19

Colour	Order no.	Qty
blue	7112	10
grey	7119	10

Domestic Panel Mounting Socket Outlet with Auxiliary Contact

- Screw terminals
- Flange 50 x 50 mm
- Mounting dimension 38 x 38 mm
- For measuring, regulating, controlling, acknowledging
- With hinged lid
- Nickel plated contacts
- Protection degree IP44

Type F - German standard

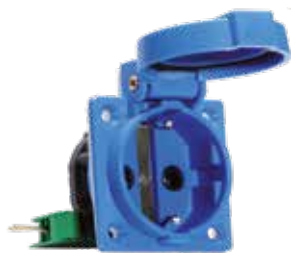

7168

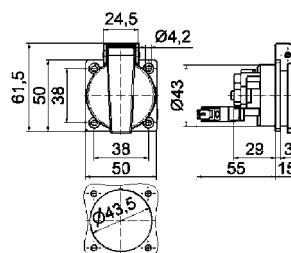

18 MB 36

Version	Colour	Order no.	Qty
NO contact	blue	7154	20
NC contact	blue	7168	20

Technical Information

- 16A / 250V~
- VDE 0620 / NBN C 61-112-1

Domestic Panel Mounting Socket Outlet

- Flange 50 x 50 mm
- Mounting dimension 38 x 38 mm
- Connection terminal in accordance with BGV A2
- Nickel plated contacts
- Protection degree IP54

Type E - Belgian/ French standard

QUICK CONNECT



7111809

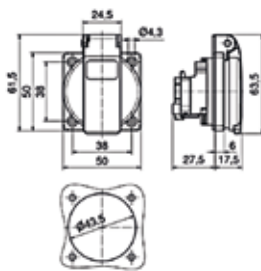

18 MB 103

Version	Colour	Order no.	Qty
QUICK CONNECT	blue	71118	20
QUICK CONNECT	grey	71119	20
QUICK CONNECT	black	71120	20
QUICK CONNECT child-proof cover	blue	7111809	20
QUICK CONNECT child-proof cover	grey	7111909	20
QUICK CONNECT child-proof cover	black	7112009	20

Domestic Panel Mounting Socket Outlet

- Screwless terminals
- Flange 75 x 75 mm
- Mounting dimension 60 x 60 mm
- Connection terminal in accordance with BGV A2
- Nickel plated contacts
- Protection degree IP54

Type E - Belgian/ French standard

QUICK CONNECT



7112109

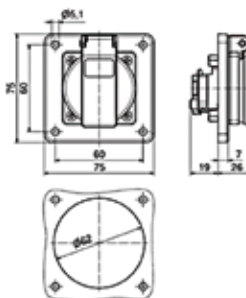

18 MB 105

Version	Colour	Order no.	Qty
QUICK CONNECT	blue	71121	20
QUICK CONNECT	grey	71122	20
QUICK CONNECT	black	71123	20
QUICK CONNECT child-proof cover	blue	7112109	20
QUICK CONNECT child-proof cover	grey	7112209	20
QUICK CONNECT child-proof cover	black	7112309	20

Domestic Panel Mounting Socket Outlet

- Screw terminals
- Flange 75 x 75 mm
- Mounting dimension 60 x 60 mm
- Nickel plated contacts
- Protection degree IP68

Type E - Belgian/ French standard

7153

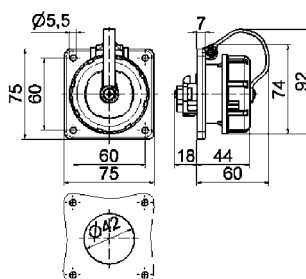

18 MB 19

Colour	Order no.	Qty
blue	7153	10
grey	71028	10

Domestic Panel Mounting Socket Outlet with Auxiliary Contact

- Screw terminals
- Flange 50 x 50 mm
- Mounting dimension 38 x 38 mm
- For measuring, regulating, controlling, acknowledging
- With hinged lid
- Nickel plated contacts
- Protection degree IP54

Type E - Belgian/ French standard

7168

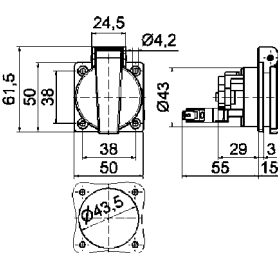

18 MB 36

Version	Colour	Order no.	Qty
NO contact	blue	71001	20
NC contact	blue	7163	20

Domestic Panel Mounting Socket Outlet

- Screw terminal
- Flange 50 x 50 mm
- Mounting dimension 38 x 38 mm
- Nickel plated contacts
- Protection degree IP44

Type G - British standard

18 MB 102

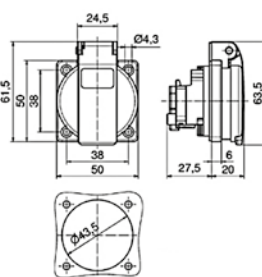

18 MB 102

Colour	Order no.	Qty
blue	71142	10

Domestic Plugs and Sockets

Danish earthing system type K and Swiss earthing system type J

Technical Information

- 16A / 250V~
- VDE 0620 / NBN C 61-112-1

Domestic Panel Mounting Socket Outlet

- Screw terminal
- Flange 50 x 50 mm
- Mounting dimension 38 x 38 mm
- Nickel plated contacts
- Protection degree IP54

Type K - Danish standard

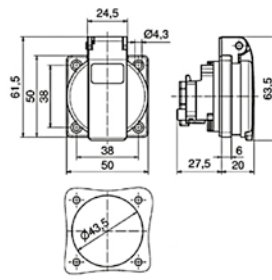

18 MB 102

Colour	Order no.	Qty
blue	71071	10

Domestic Panel Mounting Socket Outlet Typ 13

- 10A, 230V, 3p
- Screw terminal
- Flange 50 x 50 mm
- Nickel plated contacts
- Protection degree IP54

Type J - Swiss standard

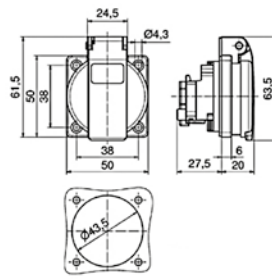

18 MB 102

Colour	Order no.	Qty
blue	770	10

Domestic Panel Mounting Socket Outlet Typ 23 with Swiss System J

- 10A, 230V, 3p
- Screw terminal
- Flange 50 x 50 mm
- Nickel plated contacts
- Protection degree IP54

Type J - Swiss standard

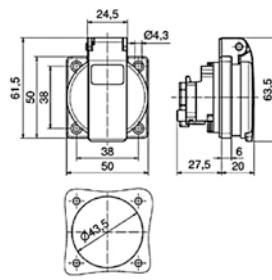

18 MB 102

Colour	Order no.	Qty
blue	776	10

Domestic Panel Mounting Socket Outlet Typ 13 with Swiss System J

- 10A, 230V, 3p
- Screw terminal
- Flange 75 x 75 mm
- Nickel plated contacts
- Protection degree IP54

Type J - Swiss standard

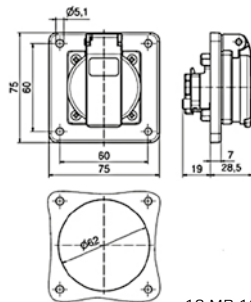

18 MB 107

Colour	Order no.	Qty
blue	772	10

Domestic Panel Mounting Socket Outlet Typ 23 with Swiss System J

- 10A, 230V, 3p
- Screw terminal
- Flange 75 x 75 mm
- Nickel plated contacts
- Protection degree IP54

Type J - Swiss standard

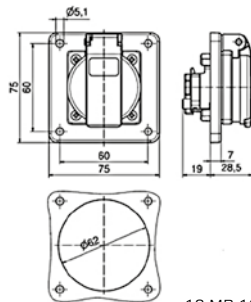

18 MB 107

Colour	Order no.	Qty
blue	779	10

Technical Information

- 16A / 250V~
- VDE 0620 / NBN C 61-112-1

Domestic Surface Mounting Socket Outlet

- Dimension of enclosure 66 x 54 mm
- Protection degree IP44



724

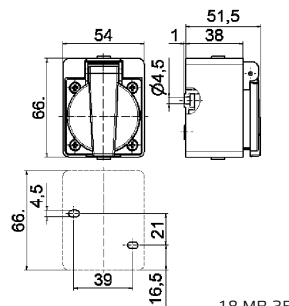

Type	Colour	Order no.	Qty
German / F	blue	724	20
German / F	black	726	20

Domestic Surface Mounting Socket Outlet

- Dimension of enclosure 102 x 102 mm
- Protection degree IP67



7245

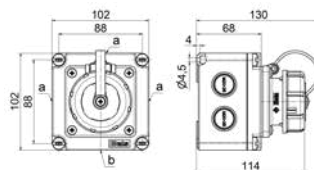

a 2xM20/M25
b 1xM20/M25
18 MB 114

Type	Colour	Order no.	Qty
German / F	blue	7245	10
Belg./French/E	blue	7246	10

Domestic Surface Mounting Socket Outlet

- Switched and electrically interlocked
- Protection degree IP67

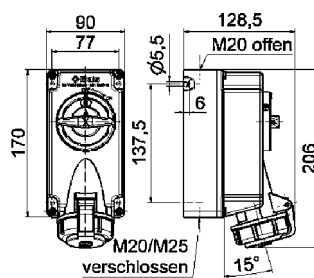

18 MB 61

Type	Colour	Order no.	Qty
German / F	blue	76100	1

Domestic Plug

- With Multi-Grip cable gland
- Spacious connection area
- Also suitable for Belgian/French system
- Protection degree IP44



7370

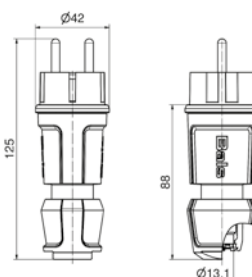

18 MB 119

Type	Colour	Order no.	Qty
German/F	blue	7370	10
Belg./French/E	blue	7370	10
German/F	grey	7371	10
Belg./French/E	grey	7371	10
German/F	black	7372	10
Belg./French/E	black	7372	10

Domestic Plug

- With cable gland
- Nickel plated contacts
- Also suitable for Belgian/French system
- With closure cap
- Protection degree IP67



736

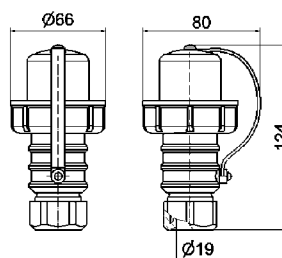

18 MB 18

Type	Colour	Order no.	Qty
German/F	blue	736	10
Belg./French/E	blue	736	10
German/F	grey	737	10
Belg./French/E	grey	737	10

Domestic Plugs and Sockets

Appliance Inlets with Flange and Connectors

Technical Information

- 16A / 250V~
- VDE 0620 / NBN C 61-112-1

Domestic Appliance Inlet with Flange

- With closure cap
- Nickel plated contacts
- Also suitable for Belgian/French system
- Protection degree IP67



754

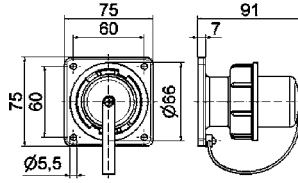

18 MB 16

Colour	Order no.	Qty
blue	754	10
grey	755	10

Domestic Connector

- Screw terminal
- With MULTI-GRIP cable gland
- Spacious connection area
- Protection degree IP54

Type F - German standard



MULTI-GRIP

7486

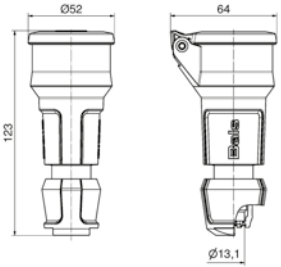

18 MB 120

Colour	Order no.	Qty
blue	7486	20
grey	7487	20
black	7488	20
red	7489	20

Domestic Connector with shutter

- Screw terminal
- With MULTI-GRIP cable gland
- Spacious connection area
- Protection degree IP54

Type F - German standard



MULTI-GRIP

748609

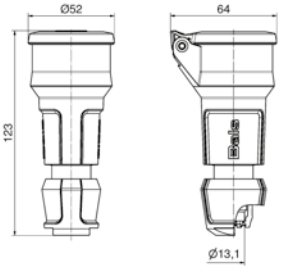

18 MB 120

Colour	Order no.	Qty
blue	748609	20
grey	748709	20
black	748809	20
red	748909	20

Domestic Connector with bleg. / france earthing system

- Screw terminal
- With MULTI-GRIP cable gland
- Spacious connection area
- Protection degree IP54

Type E - Belgian/ French standard



MULTI-GRIP

7490

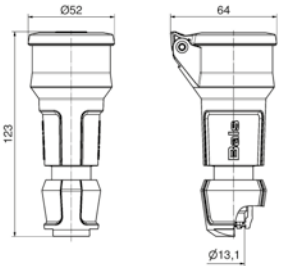

18 MB 120

Colour	Order no.	Qty
blue	7490	20
grey	7491	20
black	7492	20
red	7493	20

Domestic Connector with bleg. / france earthing system and shutter

- Screw terminal
- With MULTI-GRIP cable gland
- Spacious connection area
- Protection degree IP54

Type E - Belgian/ French standard



MULTI-GRIP

749009

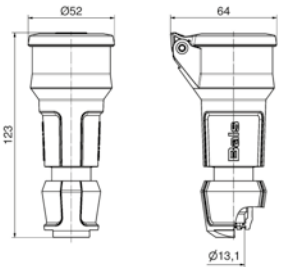

18 MB 120

Colour	Order no.	Qty
blue	749009	20
grey	749109	20
black	749209	20
red	749309	20

Technical Information

- 16A / 250V~
- VDE 0620 / NBN C 61-112-1

Domestic Connector

- With cable gland
- Nickel plated contacts
- Protection degree IP67



746

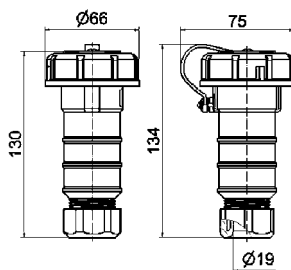

18 MB 26

Type	Colour	Order no.	Qty
German/F	blue	746	10
German/F	grey	747	10
Belg./French/E	blue	7416	10
Belg./French/E	grey	7455	10

Domestic Three-Way Connector

- With cable gland
- Nickel plated contacts
- With cover and hanging bracket
- Protection degree IP67



749

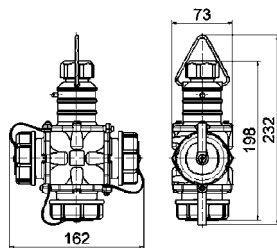

18 MB 27

Type	Colour	Order no.	Qty
German/F	blue	749	1
Belg./French/E	blue	7432	1

Extension Lead

- With domestic plug and connector
- Protection degree IP44



8156

Version	Length	Order no.	Qty
H07RN-F3G1,5	10m	8189	1
H07RN-F3G2,5	10m	8156	1
H07RN-F3G1,5	15m	8190	1
H07RN-F3G2,5	15m	8158	1
H07RN-F3G1,5	20m	8191	1
H07RN-F3G2,5	20m	8192	1

Extension Lead

- With watertight domestic plug and connector
- Protection degree IP67



8199









Version	Length	Order no.	Qty
H07RN-F3G1,5	10m	8198	1
H07RN-F3G2,5	10m	8199	1
H07RN-F3G1,5	15m	81000	1
H07RN-F3G2,5	15m	81001	1
H07RN-F3G1,5	20m	81002	1
H07RN-F3G2,5	20m	81003	1







- 1
- 2
- 3
- 4
- 5
- 6
- 7
- 8

Surface mounting distributors

 <p>VARIABOX Technical properties</p>  <p>Pages 127 - 129</p>	 <p>Plastic</p> <p>Pages 130 - 143</p>	 <p>Network sockets</p> <p>Pages 140 - 141</p>	 <p>Switched / interlocked</p> <p>Pages 142</p>	 <p>MODBOX Technical properties</p>  <p>Pages 144 - 145</p>
 <p>Solid-Rubber</p> <p>Pages 146 - 150</p>	 <p>Stainless-Steel</p> <p>Pages 151 - 154</p>			



Mobile distributors

 <p>Plastic</p> <p>Pages 156 - 157</p>	 <p>EVOBOX</p> <p>Pages 158 - 161</p>	 <p>Solid-Rubber</p> <p>Pages 162 - 170</p>
--	--	---

Hanging distributors

 <p>Plastic</p> <p>Pages 171 - 173</p>	 <p>Solid-Rubber</p> <p>Pages 174 - 176</p>
---	--

Bollards

 <p>Distribution Bollards</p> <p>Pages 177 - 179</p>	 <p>Power-Ports</p> <p>Pages 179</p>
---	---

Accessories

 <p>Accessories</p> <p>Pages 180 - 183</p>

VARIABOX

The Bals VARIABOX distributor system is even more versatile and flexible. As an adaptive further development, the new network data sockets as well as the switched interlocked CEE sockets are now available. Thus, the distributors can now be equipped with RJ45, HDMI or USB connections if necessary.

The coded flange plate with separate switch accommodates the mechanically interlocked panel mounting socket from 16A 3-pole to 32A 5-pole in IP44 or IP67 and can be perfectly integrated optically in the overall system.

Thus, the VARIABOX once again lives up to its reputation as a true all-rounder among the distributor systems. With the S, M, L, XL and XXL versions as wall-mounted or mobile combination, you will always find the right distributor for your needs – flexibly and individually configurable. A decisive advantage of the distributor is its freedom from maintenance: all panel mounting sockets are equipped with the touch-safe QUICK-CONNECT connection technology. Also unique is the operating window with OTC mechanism (one touch close).

Variabox extension – switching bar:

- Perfect optical integration in the existing system
- User-friendly arrangement in the case of multiple units
- Mechanical double-interlocking
- Can be locked in the 0-position
- Nickel plated contacts
- High-temperature-resistant contact carriers
- Greater flexibility in the Variabox system landscape
- Suitable for harsh environmental conditions
- Versions in all voltages and frequencies from 16A 3-pole to 32A 5-pole
- Protection degrees IP44, IP54 and IP67

Variabox extension – network socket:

- Perfect optical integration in the existing system
- Optionally equipped with RJ45, HDMI or USB
- Various data technology inserts available
- With protection against contact
- Protection degree IP54
- Greater flexibility in the Variabox system landscape
- Can be closed with the plugs plugged in, optionally lockable
- With labelling fields



Detailed view of switched interlocked flange plate.



The network socket with various data inserts.

Technical Data

Sizes

Version	Dimensions (H x W x D)
VARIABOX-S	130 x 230 x 145 mm
VARIABOX-M	260 x 230 x 145 mm
VARIABOX-L	390 x 230 x 145 mm
VARIABOX-XL	520 x 230 x 145 mm
VARIABOX-XXL	650 x 230 x 145 mm
VARIABOX-L DUO	390 x 460 x 145 mm
VARIABOX-XL DUO	520 x 460 x 145 mm

further modular extension possible

Colours

Top grey (standard) RAL 7035
 Top yellow, available as of 5 units
 Top blue, available as of 5 units
 Top red, available as of 5 units
 Top silver, available as of 5 units
 Bottom black RAL 9005

Shape

Cover straight,
 CEE socket angled

Material

PBT polyester

Material properties

Self-extinguishing, heat-resistant, extremely cold-resistant, resistant to ageing, saltwater-resistant, good electric insulation properties, fracture-proof, wear-resistant, abrasion-resistant, dimensionally stable

Durable

High chemical resistance, UV-stabilised, suitable for use in hostile environments

Impact resistance

IK09

Thermal resistance

DIN EN 61439 / VDE 0660-600

Ageing resistance

Long-term testing at +80 degrees

Glow wire test

In accordance with
 DIN EN60695

Protection

Top can be lead-sealed to bottom,
 OTC window can be lead-sealed

Wall mounting

Either internal or external fastening

Cover attachment

Hinged on right, can be hinged on left on request

Cover screws

Captive, with internal and external hexagon, including slot, torque 2 Nm

Cable entry

Face plates pre-punched at top and bottom
 each with M12, M20, M25/M32/M40

Attachments

User-friendly OTC mechanism (One Touch Close), CEE sockets 16A to 63A with maintenance-free QUICK-CONNECT technology, data sockets, intercompatibility of mounted sockets, optionally available with handle

Protection class

IP44, IP54, IP67

Environment

PVC-free, cadmium-free, halogen-free and silicone-free



Proper and clearly arranged wiring and an automated safety



All mounted sockets with maintenance-free QUICK-CONNECT-technology



Operating window with the unique OTC mechanism



The metric cable entries at the top and bottom

1

2

3

4

5

6

7

8

VARIABOX-S

30MB208

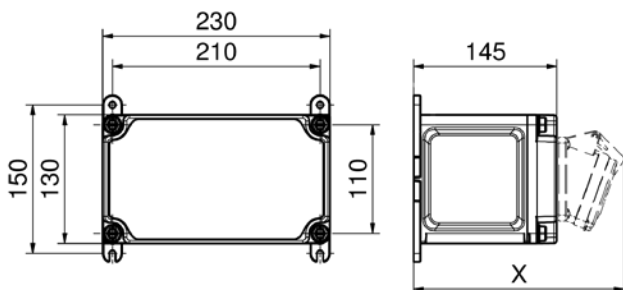

Standard cable entries pre-punched
Top: 1xM12, 1xM20, 2xM25 oder 2xM32
Bottom: 1xM12, 1xM20, 2xM25 oder 2xM32

VARIABOX-M

30MB207

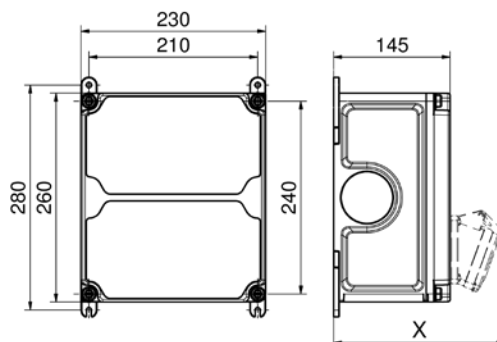

Standard cable entries pre-punched
Top: 1xM12, 1xM20, 2xM32 oder 2xM40
Bottom: 1xM12, 1xM20, 2xM32 oder 2xM40

VARIABOX-L

30MB206

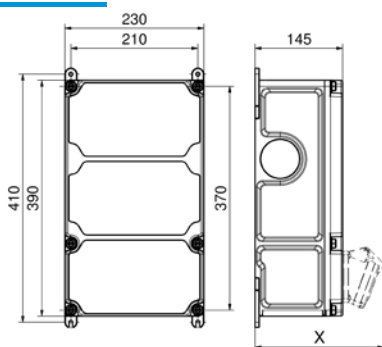

Standard cable entries pre-punched
Top: 1xM12, 1xM20, 2xM40
Bottom: 1xM12, 1xM20, 2xM40

VARIABOX-XL

30MB205

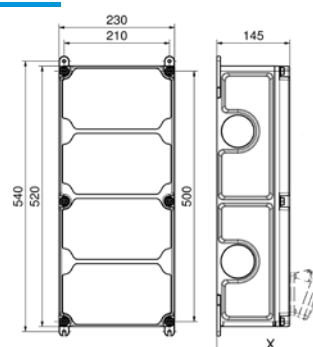

Standard cable entries pre-punched
Top: 1xM12, 1xM20, 2xM40
Bottom: 1xM12, 1xM20, 2xM40

VARIABOX-XXL

30MB204

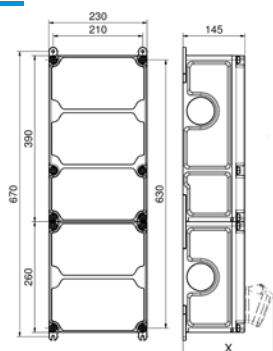

Standard cable entries pre-punched
Top: 1xM12, 1xM20, 2xM40
Bottom: 1xM12, 1xM20, 2xM40

VARIABOX-L DUO

30MB214

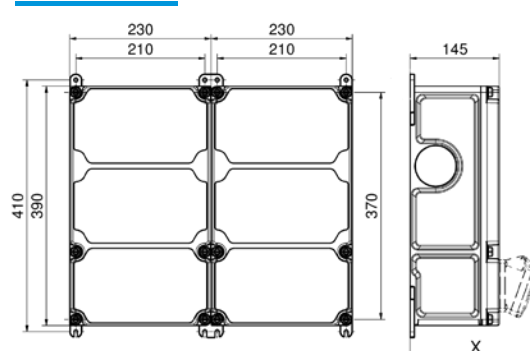

Standard cable entries pre-punched
Top: 1xM12, 1xM20, 2xM40
Bottom: 1xM12, 1xM20, 2xM40

Table X-dimension

Components	Operation window	Domestic socket		CEE 16A 3pole		CEE 16A 4pole		CEE 16A 5pole		CEE 32A 3/4pole		CEE 32A 5pole		CEE 63A	
Protection class		IP44	IP67	IP44	IP67	IP44	IP67	IP44	IP67	IP44	IP67	IP44	IP67	IP44	IP67
Depth X	180	162	205	200	200	204	202	207	205	211	213	213	214	229	231

Technical information

- Wired ready for connection
- Protection degree IP44
- All distributors comply with the DIN EN 61439 / IEC 61439

- Housing made of high-grade, impact-resistant plastic
- Top and bottom can be sealed together
- With external and internal fastening
- Permanently attached cover screws
- Top section straight, CEE sockets angled
- All CEE sockets with screwless, maintenance-free QUICK-CONNECT technology
- Colours: bottom - black, top - electro-grey (housing top optionally available in the colours yellow, red or blue)

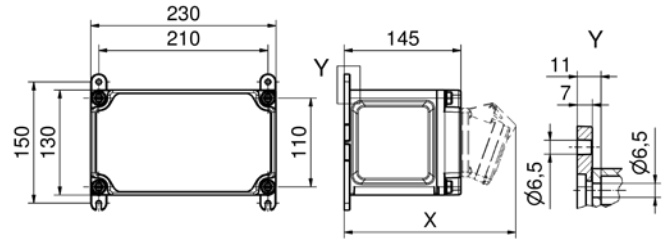

30 MB 208

Depth X (in mm)

Component	IP44	IP67	Component	IP44	IP67
OTC-window	180	180	CEE 16A 5p	207	205
Domestic socket	162	205	CEE 32A 3p / 4p	211	213
CEE 16A 3p	200	200	CEE 32A 5p	213	214
CEE 16A 4p	204	202	CEE 63A 3p / 4p / 5p	229	231

Ref. no. **89003**



Components:
3 domestic sockets 16A, 230V
(type F - German standard)

Cable entry at top and bottom:
each with 1x M12, 1x M20, 2x M25

Connection option:
for 1 cable up to 5 x 6 mm²



Ref. no. **89006**

Components:
4 domestic sockets 16A, 230V
(type F - German standard)

Cable entry at top and bottom:
each with 1x M12, 1x M20, 2x M25

Connection option:
for 1 cable up to 5 x 6 mm²



Ref. no. **89002**

Components:
1 domestic socket 16A, 230V
(type F - German standard)
1 CEE socket 16A, 400V, 5p

Cable entry at top and bottom:
each with 1x M12, 1x M20, 2x M25

Connection option:
for 1 cable up to 5 x 6 mm²



Ref. no. **89004**

Components:
2 domestic sockets 16A, 230V
(type F - German standard)
1 CEE socket 16A, 400V, 5p

Cable entry at top and bottom:
each with 1x M12, 1x M20, 2x M25

Connection option:
for 1 cable up to 5 x 6 mm²



Ref. no. **89000**

Components:
2 CEE sockets 16A, 400V, 5p

Cable entry at top and bottom:
each with 1x M12, 1x M20, 2x M25

Connection option:
for 1 cable up to 5 x 6 mm²



Ref. no. **895347**

Components:
2 domestic sockets 16A, 230V
(type F - German standard)
2 RJ45 CAT6a below operating window,
can be closed with the plugs plugged in

Cable entry at top and bottom:
1 cable gland M20 top
1 cable gland M25 with multiple sealing
insert 2 x 8 mm top
1 x M20, 1 x M25 bottom

Connection option:
for 1 cable up to 3 x 6 mm²



Technical information

- Wired ready for connection
- Protection degree IP44
- All distributors comply with the DIN EN 61439 / IEC 61439

- Housing made of high-grade, impact-resistant plastic
- Hinged lid
- Top and bottom can be sealed together
- With external and internal fastening
- User-friendly OTC operating window
- Permanently attached cover screws
- Coded flange plate system for maximum safety during initial installation and maintenance
- Top section straight, CEE sockets angled
- All CEE sockets with screwless, maintenance-free QUICK-CONNECT technology
- Colours: bottom - black, top - electro-grey (housing top optionally available in the colours yellow, red or blue)

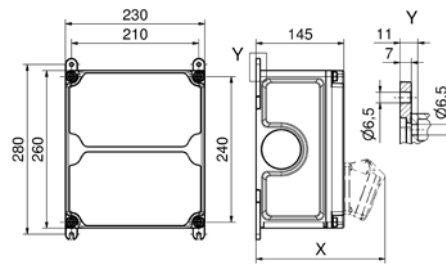

30 MB 207

Depth X (in mm)

Component	IP44	IP67	Component	IP44	IP67
OTC-window	180	180	CEE 16A 5p	207	205
Domestic socket	162	205	CEE 32A 3p / 4p	211	213
CEE 16A 3p	200	200	CEE 32A 5p	213	214
CEE 16A 4p	204	202	CEE 63A 3p / 4p / 5p	229	231

Ref. no. **89016**



Components:

3 domestic sockets 16A, 230V
(type F - German standard)

Fuse:

3 C-type MCBs 16A, 1p
1 RCCB 40/0.03A, 4p

Cable entry at top and bottom:

each with 1x M12, 1x M20, 2x M32

Connection option:

for 2 cables up to 5 x 25 mm²



Ref. no. **890400**

Components:

3 domestic sockets 16A, 230V
(type F - German standard)
1 double data socket RJ45 CAT6a IP55

Fuse:

3 C-type MCBs 16A, 1p
1 RCCB 40/0.03A, 4p

Cable entry at top and bottom:

each with 2x M20, 2x M32

Connection option:

for 2 cables up to 5 x 25 mm²



Ref. no. **89040**

Components:

4 domestic sockets 16A, 230V
(type F - German standard)

Fuse:

4 C-type MCBs 16A, 1p
1 RCCB 40/0.03A, 4p

Cable entry at top and bottom:

each with 1x M12, 1x M20, 2x M32

Connection option:

for 2 cables up to 5 x 25 mm²



Ref. no. **89037**

Components:

8 domestic sockets 16A, 230V
(type F - German standard)

Cable entry at top and bottom:

each with 1x M12, 1x M20, 2x M25

Connection option:

for 1 cable 5 x 6 mm²



Ref. no. **89044**



Components:

2 domestic sockets 16A, 230V
(type F - German standard)
1 CEE socket 16A, 400V, 5p

Fuse:

2 Neozed D01, 1p
1 Neozed D01, 3p

Cable entry at top and bottom:

each with 1x M12, 1x M20, 2x M40

Connection option:

for 2 cables up to 5 x 25 mm²



Ref. no. **89010**



Components:

2 domestic sockets 16A, 230V
(type F - German standard)
1 CEE socket 16A, 400V, 5p

Fuse:

2 C-type MCBs 16A, 1p
1 C-type MCB 16A, 3p
1 RCCB 40/0.03A, 4p

Cable entry at top and bottom:

each with 1x M12, 1x M20, 2x M40

Connection option:

for 2 cables up to 5 x 25 mm²



Technical information

- Wired ready for connection
- Protection degree IP44
- All distributors comply with the DIN EN 61439 / IEC 61439

Ref. no. **89015**

Components:

2 domestic sockets 16A, 230V
(type F - German standard)
1 CEE socket 32A, 400V, 5p

Fuse:

2 Neozed D01, 1p
1 Neozed D02, 3p

Cable entry at top and bottom:

each with 1x M12, 1x M20, 2x M40

Connection option:

for 2 cables up to 5 x 25 mm²



Ref. no. **89013**

Components:

2 domestic sockets 16A, 230V
(type F - German standard)
1 CEE socket 32A, 400V, 5p

Fuse:

2 C-type MCBs 16A, 1p
1 C-type MCB 32A, 3p
1 RCCB 40/0.03A, 4p

Cable entry at top and bottom:

each with 1x M12, 1x M20, 2x M40

Connection option:

for 2 cables up to 5 x 25 mm²



Ref. no. **89017**

Components:

2 CEE sockets 16A, 400V, 5p

Fuse:

2 C-type MCBs 16A, 3p
1 RCCB 40/0.03A, 4p

Cable entry at top and bottom:

each with 1x M12, 1x M20, 2x M40

Connection option:

for 2 cables up to 5 x 25 mm²



Ref. no. **89028**

Components:

2 domestic sockets 16A, 230V
(type F - German standard)
2 CEE sockets 16A, 400V, 5p

Cable entry at top and bottom:

each with 1x M12, 1x M20, 2x M25

Connection option:

for 1 cable 3 x 4 mm² and
1 cable 5 x 4 mm²



Ref. no. **89038**

Components:

5 domestic sockets 16A, 230V
(type F - German standard)
1 CEE socket 16A, 400V, 5p

Cable entry at top and bottom:

each with 1x M12, 1x M20, 2x M25

Connection option:

for 1 cable up to 5 x 6 mm²



Ref. no. **89022**

Components:

1 CEE socket 16A, 400V, 5p
1 CEE socket 32A, 400V, 5p

Fuse:

1 Neozed D01, 3p
1 Neozed D02, 3p

Cable entry at top and bottom:

each with 1x M12, 1x M20, 2x M40

Connection option:

for 2 cables up to 5 x 25 mm²



Ref. no. **89048**

Components:

1 CEE socket 16A, 400V, 5p
1 CEE socket 32A, 400V, 5p

Fuse:

1 C-type MCB 16A, 3p
1 C-type MCB 32A, 3p
1 RCCB 40/0.03A, 4p

Cable entry at top and bottom:

each with 1x M12, 1x M20, 2x M40

Connection option:

for 2 cables up to 5 x 25 mm²



Ref. no. **890011**

Components:

2 CEE sockets 32A, 400V, 5p

Fuse:

2 C-type MCBs 32A, 3p
1 RCCB 63/0.03A, 4p

Cable entry at top and bottom:

each with 1x M12, 1x M20, 2x M40

Connection option:

for 2 cables up to 5 x 25 mm²



Technical information

- Wired ready for connection
- Protection degree IP44
- All distributors comply with the DIN EN 61439 / IEC 61439

- Housing made of high-grade, impact-resistant plastic
- Hinged lid
- Top and bottom can be sealed together
- With external and internal fastening
- User-friendly OTC operating window
- Permanently attached cover screws
- Coded flange plate system for maximum safety during initial installation and maintenance
- Top section straight, CEE sockets angled
- All CEE sockets with screwless, maintenance-free QUICK-CONNECT technology
- Colours: bottom - black, top - electro-grey (housing top optionally available in the colours yellow, red or blue)

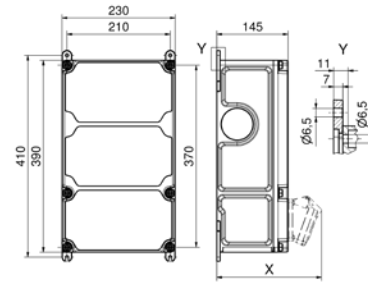

30 MB 206

Depth X (in mm)

Component	IP44	IP67	Component	IP44	IP67
OTC-window	180	180	CEE 16A 5p	207	205
Domestic socket	162	205	CEE 32A 3p / 4p	211	213
CEE 16A 3p	200	200	CEE 32A 5p	213	214
CEE 16A 4p	204	202	CEE 63A 3p / 4p / 5p	229	231

Ref. no. **89084**

Components:

6 domestic sockets 16A, 230V
(system F - German earthing system)(type F - German standard)

Fuse:

6 C-type MCBs 16A, 1p
1 RCCB 40/0.03A, 4p

Cable entry at top and bottom:

each with 1x M12, 1x M20, 2x M40

Connection option:

for 2 cables up to 5 x 25 mm²



Ref. no. **89085**

Components:

2 domestic sockets 16A, 230V
(type F - German standard)
2 CEE sockets 16A, 400V, 5p

Fuse:

2 Neozed D01, 1p
2 Neozed D01, 3p

Cable entry at top and bottom:

each with 1x M12, 1x M20, 2x M40

Connection option:

for 2 cables up to 5 x 25 mm²



ex stock

Ref. no. **89075**

Components:

2 domestic sockets 16A, 230V
(type F - German standard)
2 CEE sockets 16A, 400V, 5p

Fuse:

2 C-type MCBs 16A, 1p
2 C-type MCBs 16A, 3p
1 RCCB 40/0.03A, 4p

Cable entry at top and bottom:

each with 1x M12, 1x M20, 2x M40

Connection option:

for 2 cables up to 5 x 25 mm²



ex stock

Ref. no. **89086**

Components:

2 domestic sockets 16A, 230V
(type F - German standard)
1 CEE socket 16A, 400V, 5p
1 CEE socket 32A, 400V, 5p

Fuse:

2 Neozed D01, 1p
1 Neozed D01, 3p
1 Neozed D02, 3p

Cable entry at top and bottom:

each with 1x M12, 1x M20, 2x M40

Connection option:

for 2 cables up to 5 x 25 mm²



ex stock

Ref. no. **89076**

Components:

2 domestic sockets 16A, 230V
(type F - German standard)
1 CEE socket 16A, 400V, 5p
1 CEE socket 32A, 400V, 5p

Fuse:

2 C-type MCBs 16A, 1p
1 C-type MCB 16A, 3p
1 C-type MCB 32A, 3p
1 RCCB 40/0.03A, 4p

Cable entry at top and bottom:

each with 1x M12, 1x M20, 2x M40

Connection option:

for 2 cables up to 5 x 25 mm²



ex stock

Ref. no. **89070**

Components:

3 domestic sockets 16A, 230V
(type F - German standard)
1 CEE socket 16A, 400V, 5p
1 CEE socket 32A, 400V, 5p

Fuse:

3 C-type MCBs 16A, 1p
1 C-type MCB 16A, 3p
1 C-type MCB 32A, 3p

Cable entry at top and bottom:

each with 1x M12, 1x M20, 2x M40

Connection option:

for 2 cables up to 5 x 25 mm²



ex stock

Technical information

- Wired ready for connection
- Protection degree IP44
- All distributors comply with the DIN EN 61439 / IEC 61439

- Housing made of high-grade, impact-resistant plastic
- Hinged lid
- Top and bottom can be sealed together
- With external and internal fastening
- User-friendly OTC operating window
- Permanently attached cover screws
- Coded flange plate system for maximum safety during initial installation and maintenance
- Top section straight, CEE sockets angled
- All CEE sockets with screwless, maintenance-free QUICK-CONNECT technology
- Colours: bottom - black, top - electro-grey (housing top optionally available in the colours yellow, red or blue)

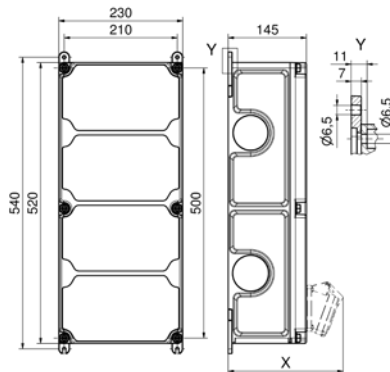

Depth X (in mm)

Component	IP44	IP67
OTC-window	180	180
Domestic socket	162	205
CEE 16A 3p	200	200
CEE 16A 4p	204	202
CEE 16A 5p	207	205
CEE 32A 3p / 4p	211	213
CEE 32A 5p	213	214
CEE 63A 3p / 4p / 5p	229	231

30 MB 205

Ref. no. **89146**



Components:

2 domestic sockets 16A, 230V (type F - German standard)
2 CEE sockets 32A, 400V, 5p

Fuse:

2 Neozed D01, 1p
2 Neozed D02, 3p

Cable entry at top and bottom:

each with 1x M12, 1x M20, 2x M40

Connection option:

for 2 cables up to 5 x 25 mm²



Ref. no. **89107**



Components:

3 domestic sockets 16A, 230V (type F - German standard)
2 CEE sockets 32A, 400V, 5p

Fuse:

3 C-type MCBs 16A, 1p
2 C-type MCBs 32A, 3p
1 RCCB 63/0.03A, 4p

Cable entry at top and bottom:

each with 1x M12, 1x M20, 2x M40

Connection option:

for 2 cables up to 5 x 25 mm²



Ref. no. **89094**



Components:

2 domestic sockets 16A, 230V (type F - German standard)
1 CEE socket 16A, 400V, 5p
1 CEE socket 32A, 400V, 5p

Fuse:

2 Neozed D01, 1p
1 Neozed D01, 3p
1 Neozed D02, 3p
1 RCCB 63/0.03A, 4p

Cable entry at top and bottom:

each with 1x M12, 1x M20, 2x M40

Connection option:

for 2 cables up to 5 x 25 mm²



Ref. no. **89099**



Components:

3 domestic sockets 16A, 230V (type F - German standard)
1 CEE socket 16A, 400V, 5p
1 CEE socket 32A, 400V, 5p

Fuse:

3 C-type MCBs 16A, 1p
1 C-type MCB 16A, 3p
1 C-type MCB 32A, 3p
1 RCCB 63/0.03A, 4p

Cable entry at top and bottom:

each with 1x M12, 1x M20, 2x M40

Connection option:

for 2 cables up to 5 x 25 mm²



Ref. no. **89101**



Components:

4 domestic sockets 16A, 230V (type F - German standard)
1 CEE socket 16A, 400V, 5p
1 CEE socket 32A, 400V, 5p

Fuse:

4 C-type MCBs 16A, 1p
1 C-type MCB 16A, 3p
1 C-type MCB 32A, 3p
1 RCCB 40/0.03A, 4p

Cable entry at top and bottom:

each with 1x M12, 1x M20, 2x M40

Connection option:

for 2 cables up to 5 x 25 mm²



Ref. no. **89095**



Components:

2 domestic sockets 16A, 230V (type F - German standard)
1 CEE socket 16A, 400V, 5p
1 CEE socket 32A, 400V, 5p
1 CEE socket 63A, 400V, 5p

Fuse:

2 C-type MCBs 16A, 1p
1 C-type MCB 16A, 3p
1 C-type MCB 32A, 3p
1 RCCB 63/0.03A, 4p

Cable entry at top and bottom:

each with 1x M12, 1x M20, 2x M40

Connection option:

for 2 cables up to 5 x 25 mm²



Technical information

- Wired ready for connection
- Protection degree IP44
- All distributors comply with the DIN EN 61439 / IEC 61439

- Housing made of high-grade, impact-resistant plastic
- Hinged lid
- Top and bottom can be sealed together
- With external and internal fastening
- User-friendly OTC operating window
- Permanently attached cover screws
- Coded flange plate system for maximum safety during initial installation and maintenance
- Top section straight, CEE sockets angled
- All CEE sockets with screwless, maintenance-free QUICK-CONNECT technology
- Colours: bottom - black, top - electro-grey (housing top optionally available in the colours yellow, red or blue)

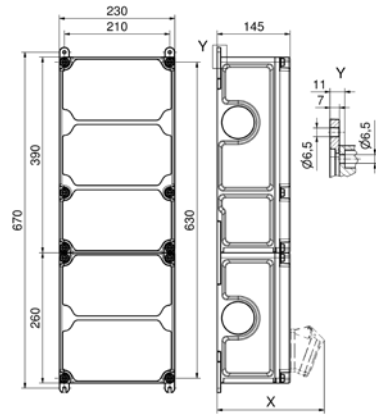

Depth X (in mm)

Component	IP44	IP67
OTC-window	180	180
Domestic socket	162	205
CEE 16A 3p	200	200
CEE 16A 4p	204	202
CEE 16A 5p	207	205
CEE 32A 3p / 4p	211	213
CEE 32A 5p	213	214
CEE 63A 3p / 4p / 5p	229	231

30 MB 204

Ref. no. **89127**



Components:

4 domestic sockets 16A, 230V
(type F - German standard)
3 CEE sockets 16A, 400V, 5p

Fuse:

4 C-type MCBs 16A, 1p
3 C-type MCBs 16A, 3p
1 RCCB 63/0.03A, 4p

Cable entry at top and bottom:

each with 1x M12, 1x M20, 2x M40

Connection option:

for 2 cables up to 5 x 25 mm²



Ref. no. **89122**

Components:

6 CEE sockets 16A, 230V, 3p

Fuse:

6 C-type MCBs 16A, 1p
6 RCCB 25/0.03A, 2p

Cable entry at top and bottom:

each with 1x M12, 1x M20, 2x M40

Connection option:

for 2 cables up to 5 x 25 mm²



Ref. no. **89120**

Components:

6 domestic sockets 16A, 230V
(type F - German standard)
1 CEE socket 16A, 400V, 5p
1 CEE socket 32A, 400V, 5p

Fuse:

6 C-type MCBs 16A, 1p
1 C-type MCB 16A, 3p
1 C-type MCB 32A, 3p
1 RCCB 63/0.03A, 4p

Cable entry at top and bottom:

each with 1x M12, 1x M20, 2x M40

Connection option:

for 2 cables up to 5 x 25 mm²



Ref. no. **89119**



Components:

4 domestic sockets 16A, 230V
(type F - German standard)
2 CEE sockets 16A, 400V, 5p
1 CEE socket 32A, 400V, 5p

Fuse:

4 C-type MCBs 16A, 1p
2 C-type MCBs 16A, 3p
1 C-type MCB 32A, 3p
1 RCCB 63/0.03A, 4p

Cable entry at top and bottom:

each with 1x M12, 1x M20, 2x M40

Connection option:

for 2 cables up to 5 x 25 mm²



Ref. no. **89142**

Components:

3 domestic sockets 16A, 230V
(type F - German standard)
2 CEE sockets 16A, 400V, 5p
2 CEE sockets 32A, 400V, 5p

Fuse:

3 C-type MCBs 16A, 1p
2 C-type MCBs 16A, 3p
2 C-type MCBs 32A, 3p
1 RCCB 63/0.03A, 4p

Cable entry at top and bottom:

each with 1x M12, 1x M20, 2x M40

Connection option:

for 2 cables up to 5 x 25 mm²



Ref. no. **89123**

Components:

2 domestic sockets 16A, 230V
(type F - German standard)
1 CEE socket 16A, 400V, 5p
1 CEE socket 32A, 400V, 5p
1 CEE socket 63A, 400V, 5p

Fuse:

2 C-type MCBs 16A, 1p
1 C-type MCB 16A, 3p
1 C-type MCB 32A, 3p
1 Neozed D02, 3p
1 RCCB 63/0.03A, 4p

Cable entry at top and bottom:

each with 1x M12, 1x M20, 2x M40

Connection option:

for 2 cables up to 5 x 25 mm²



Technical information

- Wired ready for connection
- Protection degree IP44
- All distributors comply with the DIN EN 61439 / IEC 61439

- Housing made of high-grade, impact-resistant plastic
- Hinged lid
- Top and bottom can be sealed together
- With external and internal fastening
- User-friendly OTC operating window
- Permanently attached cover screws
- Coded flange plate system for maximum safety during initial installation and maintenance
- Top section straight, CEE sockets angled
- All CEE sockets with screwless, maintenance-free QUICK-CONNECT technology
- Colours: bottom - black, top - electro-grey (housing top optionally available in the colours yellow, red or blue)

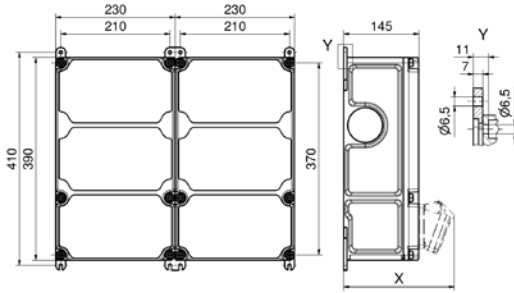

30 MB 214

Depth X (in mm)

Component	IP44	IP67	Component	IP44	IP67
OTC-window	180	180	CEE 16A 5p	207	205
Domestic socket	162	205	CEE 32A 3p / 4p	211	213
CEE 16A 3p	200	200	CEE 32A 5p	213	214
CEE 16A 4p	204	202	CEE 63A 3p / 4p / 5p	229	231

Ref. no. **89128**

Components:

- 4 domestic sockets 16A, 230V (type F - German standard)
- 3 CEE sockets 16A, 400V, 5p

Fuse:

- 4 Neozed D01, 1p
- 3 Neozed D01, 3p

Cable entry at top and bottom:

each with 1x M12, 1x M20, 2x M40

Connection option:

for 2 cables up to 5 x 25 mm²



Ref. no. **89129**

Components:

- 4 domestic sockets 16A, 230V (type F - German standard)
- 1 CEE socket 16A, 230V, 3p
- 1 CEE socket 16A, 400V, 5p
- 1 CEE socket 32A, 400V, 5p

Fuse:

- 5 Neozed D01, 1p
- 1 Neozed D01, 3p
- 1 Neozed D02, 3p
- 1 RCCB 63/0.03A, 4p

Cable entry at top and bottom:

each with 1x M12, 1x M20, 2x M40

Connection option:

for 2 cables up to 5 x 25 mm²



Ref. no. **89134**

Components:

- 4 domestic sockets 16A, 230V (type F - German standard)
- 2 CEE sockets 16A, 400V, 5p
- 1 CEE socket 32A, 400V, 5p

Fuse:

- 4 Neozed D01, 1p
- 2 Neozed D01, 3p
- 1 Neozed D02, 3p
- 1 RCCB 63/0.03A, 4p

Cable entry at top and bottom:

each with 1x M12, 1x M20, 2x M40

Connection option:

for 2 cables up to 5 x 25 mm²



Ref. no. **890083**

Components:

- 4 domestic sockets 16A, 230V (type F - German standard)
- 1 CEE socket 16A, 400V, 5p
- 1 CEE socket 32A, 400V, 5p
- 1 CEE socket 63A, 400V, 5p
- 1 double data socket RJ45 CAT6a IP55

Fuse:

- 4 C-type MCBs 16A, 1p
- 1 C-type MCB 16A, 3p
- 1 C-type MCB 32A, 3p
- 1 C-type MCB 63A, 3p
- 1 RCCB 63/0.03A, 4p

Cable entry at top and bottom:

each with 2x M20, 2x M40

Connection option:

for 2 cables up to 5 x 25 mm²



Ref. no. **89148**

Components:

- 6 domestic sockets 16A, 230V (type F - German standard)
- 1 CEE socket 16A, 400V, 5p
- 1 CEE socket 32A, 400V, 5p
- 1 CEE socket 63A, 400V, 5p

Fuse:

- 3 Neozed D01, 1p
- 1 Neozed D01, 3p
- 1 Neozed D02, 3p
- 1 RCCB 63/0.03A, 4p

Cable entry at top and bottom:

each with 1x M12, 1x M20, 2x M40

Connection option:

for 2 cables up to 5 x 25 mm²



Ref. no. **89987**

Components:

- 10 domestic sockets 16A, 230V (type F - German standard)
- 1 CEE socket 16A, 400V, 5p
- 1 CEE socket 32A, 400V, 5p

Fuse:

- 10 C-type MCBs 16A, 1p
- 1 C-type MCB 16A, 3p
- 1 C-type MCB 32A, 3p
- 1 RCCB 63/0.03A, 4p

Cable entry at top and bottom:

each with 1x M12, 1x M20, 2x M40

Connection option:

for 2 cables up to 5 x 25 mm²



Technical information

- Wired ready for connection
- Protection degree IP67
- All distributors comply with the DIN EN 61439 / IEC 61439

- Housing made of high-grade, impact-resistant plastic
- Top and bottom can be sealed together
- With external and internal fastening
- Permanently attached cover screws
- Top section straight, CEE sockets angled
- All CEE sockets with screwless, maintenance-free QUICK-CONNECT technology
- Colours: bottom - black, top - electro-grey (housing top optionally available in the colours yellow, red or blue)

Ref. no. **890919**

Components:

2 domestic sockets 16A, 230V
(type F - German standard)

Cable entry at top and bottom:

each with 1x M12, 1x M20, 2x M25

Connection option:

for 1 cable up to 3 x 4 mm²



Ref. no. **890920**

Components:

1 domestic socket 16A, 230V
(type F - German standard)
1 CEE socket 16A, 400V, 5p

Cable entry at top and bottom:

each with 1x M12, 1x M20, 2x M25

Connection option:

for 1 cable up to 5 x 4 mm²



Ref. no. **890921**

Components:

1 domestic socket 16A, 230V
(type F - German standard)
1 CEE socket 16A, 400V, 5p

Fuse:

1 C-type MCB 16A, 1p
1 C-type MCB 16A, 3p
1 RCCB 40/0.03A, 4p

Cable entry at top and bottom:

each with 1x M12, 1x M20, 2x M40

Connection option:

for 2 cables up to 5 x 25 mm²



Ref. no. **890922**

Components:

1 domestic socket 16A, 230V
(type F - German standard)
1 CEE socket 32A, 400V, 5p

Fuse:

1 C-type MCB 16A, 1p
1 C-type MCB 32A, 3p
1 RCCB 40/0.03A, 4p

Cable entry at top and bottom:

each with 1x M12, 1x M20, 2x M40

Connection option:

for 2 cables up to 5 x 25 mm²



Ref. no. **890923**

Components:

2 domestic sockets 16A, 230V
(type F - German standard)
1 CEE socket 16A, 400V, 5p
1 CEE socket 32A, 400V, 5p

Fuse:

2 C-type MCBs 16A, 1p
1 C-type MCB 16A, 3p
1 RCCB 40/0.03A, 4p

Cable entry at top and bottom:

each with 1x M12, 1x M20, 2x M40

Connection option:

for 2 cables up to 5 x 25 mm²



Ref. no. **890924**

Components:

2 domestic sockets 16A, 230V
(type F - German standard)
1 CEE socket 16A, 400V, 5p
1 CEE socket 32A, 400V, 5p

Fuse:

2 C-type MCBs 16A, 1p
1 C-type MCB 16A, 3p
1 C-type MCB 32A, 3p

Cable entry at top and bottom:

each with 1x M12, 1x M20, 2x M40

Connection option:

for 2 cables up to 5 x 25 mm²



Technical information

- Wired ready for connection
- Protection degree IP67
- All distributors comply with the DIN EN 61439 / IEC 61439

Ref. no. **890925**

Components:

3 domestic sockets 16A, 230V
(type F - German standard)
1 CEE socket 16A, 400V, 5p

Fuse:

3 C-type MCBs 16A, 1p
1 C-type MCB 16A, 3p
1 RCCB 40/0.03A, 4p

Cable entry at top and bottom:

each with 1x M12, 1x M20, 2x M40

Connection option:

for 2 cables up to 5 x 25 mm²



Ref. no. **890926**

Components:

3 domestic sockets 16A, 230V
(type F - German standard)
1 CEE socket 32A, 400V, 5p

Fuse:

3 C-type MCBs 16A, 1p
1 C-type MCB 32A, 3p
1 RCCB 40/0.03A, 4p

Cable entry at top and bottom:

each with 1x M12, 1x M20, 2x M40

Connection option:

for 2 cables up to 5 x 25 mm²



Ref. no. **890927**

Components:

2 domestic sockets 16A, 230V
(type F - German standard)
2 CEE sockets 16A, 400V, 5p

Fuse:

2 C-type MCBs 16A, 1p
2 C-type MCBs 16A, 3p

Cable entry at top and bottom:

each with 1x M12, 1x M20, 2x M40

Connection option:

for 2 cables up to 5 x 25 mm²



Ref. no. **890928**

Components:

2 domestic sockets 16A, 230V
(type F - German standard)
2 CEE sockets 32A, 400V, 5p

Fuse:

2 C-type MCBs 16A, 1p
2 C-type MCBs 32A, 3p

Cable entry at top and bottom:

each with 1x M12, 1x M20, 2x M40

Connection option:

for 2 cables up to 5 x 25 mm²



Ref. no. **890929**

Components:

2 domestic sockets 16A, 230V
(type F - German standard)
1 CEE socket 16A, 400V, 5p
1 CEE socket 32A, 400V, 5p

Fuse:

2 C-type MCBs 16A, 1p
1 C-type MCB 16A, 3p
1 C-type MCB 32A, 3p
1 RCCB 40/0.03A, 4p

Cable entry at top and bottom:

each with 1x M12, 1x M20, 2x M40

Connection option:

for 2 cables up to 5 x 25 mm²



Ref. no. **890930**

Components:

2 domestic sockets 16A, 230V
(type F - German standard)
1 CEE socket 16A, 400V, 5p
1 CEE socket 32A, 400V, 5p

Fuse:

2 C-type MCBs 16A, 1p
1 C-type MCB 16A, 3p
1 C-type MCB 32A, 3p
1 RCCB 63/0.03A, 4p

Cable entry at top and bottom:

each with 1x M12, 1x M20, 2x M40

Connection option:

for 2 cables up to 5 x 25 mm²



Ref. no. **890931**

Components:

3 domestic sockets 16A, 230V
(type F - German standard)
1 CEE socket 16A, 400V, 5p
1 CEE socket 32A, 400V, 5p

Fuse:

3 C-type MCBs 16A, 1p
1 C-type MCB 16A, 3p
1 C-type MCB 32A, 3p
1 RCCB 63/0.03A, 4p

Cable entry at top and bottom:

each with 1x M12, 1x M20, 2x M40

Connection option:

for 2 cables up to 5 x 25 mm²



Ref. no. **890932**

Components:

2 domestic sockets 16A, 230V
(type F - German standard)
2 CEE sockets 16A, 400V, 5p

Fuse:

2 C-type MCBs 16A, 1p
2 C-type MCBs 16A, 3p
1 RCCB 40/0.03A, 4p

Cable entry at top and bottom:

each with 1x M12, 1x M20, 2x M40

Connection option:

for 2 cables up to 5 x 25 mm²



Technical information

- Wired ready for connection
- Protection degree IP67
- All distributors comply with the DIN EN 61439 / IEC 61439

Ref. no. **890933**

Components:

2 domestic sockets 16A, 230V
(type F - German standard)
2 CEE sockets 32A, 400V, 5p

Fuse:

2 C-type MCBs 16A, 1p
2 C-type MCBs 32A, 3p
1 RCCB 63/0.03A, 4p

Cable entry at top and bottom:

each with 1x M12, 1x M20, 2x M40

Connection option:

for 2 cables up to 5 x 25 mm²



Ref. no. **890934**

Components:

3 domestic sockets 16A, 230V
(type F - German standard)
2 CEE sockets 16A, 400V, 5p

Fuse:

3 C-type MCBs 16A, 1p
2 C-type MCBs 16A, 3p
1 RCCB 40/0.03A, 4p

Cable entry at top and bottom:

each with 1x M12, 1x M20, 2x M40

Connection option:

for 2 cables up to 5 x 25 mm²



Ref. no. **890935**

Components:

2 domestic sockets 16A, 230V
(type F - German standard)
1 CEE socket 16A, 400V, 5p
1 CEE socket 32A, 400V, 5p
1 CEE socket 63A, 400V, 5p

Fuse:

2 C-type MCBs 16A, 1p
1 C-type MCB 16A, 3p
1 C-type MCB 32A, 3p
1 RCCB 63/0.03A, 4p

Cable entry at top and bottom:

each with 1x M12, 1x M20, 2x M40

Connection option:

for 2 cables up to 5 x 25 mm²



Ref. no. **890936**

Components:

3 domestic sockets 16A, 230V
(type F - German standard)
2 CEE sockets 16A, 400V, 5p
1 CEE socket 32A, 400V, 5p

Fuse:

3 C-type MCBs 16A, 1p
2 C-type MCBs 16A, 3p
1 C-type MCB 32A, 3p
1 RCCB 63/0.03A, 4p

Cable entry at top and bottom:

each with 1x M12, 1x M20, 2x M40

Connection option:

for 2 cables up to 5 x 25 mm²



Ref. no. **890937**

Components:

3 domestic sockets 16A, 230V
(type F - German standard)
1 CEE socket 16A, 400V, 5p
1 CEE socket 32A, 400V, 5p
1 CEE socket 63A, 400V, 5p

Fuse:

3 C-type MCBs 16A, 1p
1 C-type MCB 16A, 3p
1 C-type MCB 32A, 3p
1 RCCB 63/0.03A, 4p

Cable entry at top and bottom:

each with 1x M12, 1x M20, 2x M40

Connection option:

for 2 cables up to 5 x 25 mm²



Ref. no. **890938**

Components:

3 domestic sockets 16A, 230V
(type F - German standard)
1 CEE socket 16A, 400V, 5p
2 CEE sockets 32A, 400V, 5p

Fuse:

3 C-type MCBs 16A, 1p
1 C-type MCB 16A, 3p
2 C-type MCBs 32A, 3p
1 RCCB 63/0.03A, 4p

Cable entry at top and bottom:

each with 1x M12, 1x M20, 2x M40

Connection option:

for 2 cables up to 5 x 25 mm²



Ref. no. **890939**

Components:

2 domestic sockets 16A, 230V
(type F - German standard)
2 CEE sockets 16A, 400V, 5p
1 CEE socket 32A, 400V, 5p
1 CEE socket 63A, 400V, 5p

Fuse:

1 C-type MCB 16A, 1p
2 C-type MCBs 16A, 3p
1 C-type MCB 32A, 3p
1 RCCB 63/0.03A, 4p

Cable entry at top and bottom:

each with 1x M12, 1x M20, 2x M40

Connection option:

for 2 cables up to 5 x 25 mm²



Ref. no. **890940**

Components:

2 domestic sockets 16A, 230V
(type F - German standard)
1 CEE socket 16A, 400V, 5p
1 CEE socket 32A, 400V, 5p
1 CEE socket 63A, 400V, 5p

Fuse:

2 C-type MCBs 16A, 1p
1 C-type MCB 16A, 3p
1 C-type MCB 32A, 3p
1 C-type MCB 63A, 3p
1 RCCB 63/0.03A, 4p

Cable entry at top and bottom:

each with 1x M12, 1x M20, 2x M40

Connection option:

for 2 cables up to 5 x 25 mm²



Technical information

- Wired ready for connection
- Protection degree IP54
- All distributors comply with the DIN EN 61439 / IEC 61439

VARIABOX extension – network socket:

- Perfect optical integration in the existing system
- Optionally equipped with RJ45, HDMI or USB
- Various data technology inserts available
- With protection against contact
- Protection degree IP54
- Greater flexibility in the Variabox system landscape
- Can be closed with the plugs plugged in, optionally lockable
- With labelling fields



Detailed view of the network socket.

Ref. no. **893419**

Components:

2 RJ45 CAT6a below operating window, can be closed with the plugs plugged in

Cable entry:

2 x M25 top closed
1 x M25 bottom
1 x cable gland M25 with multiple sealing insert 2 x 8 mm bottom



Ref. no. **896346**

Components:

2 RJ45 CAT6a below operating window, can be closed with the plugs plugged in

Cable entry:

1 x M12, 1 x M20, 2 x M25 top
1 x M12, 1 x M20 bottom
2 x cable gland M25 with multiple sealing insert 2 x 8 mm bottom



Ref. no. **895347**

Components:

2 domestic sockets 16A, 230V (type F - German standard)
2 RJ45 CAT6a below operating window, can be closed with the plugs plugged in

Cable entry:

1 x cable gland M20 top
1 x cable gland M25 with multiple sealing insert 2 x 8 mm top
1 x M20, 1 x M25 bottom



Ref. no. **896347**

Components:

2 domestic sockets 16A, 230V (type F - German standard)
4 RJ45 CAT6a below operating window, can be closed with the plugs plugged in

Cable entry:

1 x cable gland M20 top
1 x cable gland M32 with multiple sealing insert 4 x 8 mm top
1 x M20, 1 x M32 bottom



Connection option:

for 1 cable up to 3 x 6 mm²

Connection option:

for 1 cable up to 3 x 6 mm²

Ref. no. **896329**

Components:

2 domestic sockets 16A, 230V (type F - German standard)
2 RJ45 CAT6a below operating window, can be closed with the plugs plugged in

Cable entry:

1 x M12, 1 x M20 top
1 x cable gland M25
1 x cable gland M25 with multiple sealing insert 2 x 8 mm bottom
1 x M12, 1 x M20, 2 x M25 unten



Ref. no. **896400**

Components:

2 domestic sockets 16A, 230V (type F - German standard)
2 RJ45 CAT6a below operating window, can be closed with the plugs plugged in

Fuse:

2 C-type MCBs 16A, 1p
1 RCCB 40/0.03A, 4p

Cable entry:

1 x M20, 1 x M25 top closed
1 x cable gland M20 bottom
1 x cable gland M25 with multiple sealing insert 2 x 8 mm bottom



Connection option:

for 1 cable up to 3 x 6 mm²

Network socket

- For max. 4 data modules
- With 4 blank cover
- With protection cover plate
- Can be closed with the plugs plugged in, optionally lockable

Ref. no. **581276**



Data module RJ45 CAT 6a

- KeyStone module
- 10 Gigabit-Ethernet
- Insulation displacement contact

Manufacturer	Ref. no.
BTR	50003186
R&M	50002819
AMP	50003206
Dätwyler	50003208
Corning	50003209
3M	50003210
Telegärtner	50003211



Data module USB 2.0 A/A

- KeyStone module
- Colour: black

Ref. no. **50003218**



Data module USB 2.0 A/B

- KeyStone module
- Colour: white

Ref. no. **50003205**



Data module HDMI

- HDMI double socket
- KeyStone module
- Gold plated contacts
- Colour: white

Ref. no. **50003203**



KeyStone Blank Cover

- Colour: white

Ref. no. **20001402**



1

2

3

4

5

6

7

8

Variabox extension – switching bar:

- Perfect optical integration in the existing system
- User-friendly arrangement in the case of multiple units
- Mechanical double-interlocking
- Can be locked in the 0-position
- Nickel plated contacts
- High-temperature-resistant contact carriers
- Greater flexibility in the Variabox system landscape
- Suitable for harsh environmental conditions
- Versions in all voltages and frequencies from 16A 3-pole to 32A 5-pole
- Protection degrees IP44, IP54 and IP67



Detailed view of switched interlocked flange plate.

Ref. no. **896373**

Components:

1 CEE socket 16A, 400V, 5p, IP44
 nickel plated contacts, with mechanical interlocking, lockable in 0-position

Fuse:

1 C-type MCB 16A, 3p
 1 RCCB 40/0.03A, 4p

Cable entry at top and bottom:

each with 1x M12, 1x M20, 2x M40

Connection option:

for 2 cables up to 5 x 25 mm²



Ref. no. **896285**

Components:

1 CEE socket 16A, 400V, 5p, IP67
 nickel plated contacts, with mechanical interlocking, lockable in 0-position

Fuse:

1 C-type MCB 16A, 3p
 1 RCCB 40/0.03A, 4p

Cable entry at top and bottom:

each with 1x M12, 1x M20, 2x M40

Connection option:

for 2 cables up to 5 x 25 mm²



Ref. no. **896374**

Components:

1 CEE socket 32A, 400V, 5p, IP44
 nickel plated contacts, with mechanical interlocking, lockable in 0-position

Fuse:

1 C-type MCB 32A, 3p
 1 RCCB 40/0.03A, 4p

Cable entry at top and bottom:

each with 1x M12, 1x M20, 2x M40

Connection option:

for 2 cables up to 5 x 25 mm²



Ref. no. **896368**

Components:

1 CEE socket 32A, 400V, 5p, IP67
 nickel plated contacts, with mechanical interlocking, lockable in 0-position

Fuse:

1 C-type MCB 32A, 3p
 1 RCCB 40/0.03A, 4p

Cable entry at top and bottom:

each with 1x M12, 1x M20, 2x M40

Connection option:

for 2 cables up to 5 x 25 mm²



Ref. no. **896376**

Components:

2 CEE sockets 16A, 400V, 5p, IP44
 nickel plated contacts, with mechanical interlocking, lockable in 0-position

Fuse:

2 C-type MCBs 16A, 3p
 1 RCCB 40/0.03A, 4p

Cable entry at top and bottom:

each with 1x M12, 1x M20, 2x M40

Connection option:

for 2 cables up to 5 x 25 mm²



Ref. no. **896377**

Components:

2 CEE sockets 16A, 400V, 5p, IP67
 nickel plated contacts, with mechanical interlocking, lockable in 0-position

Fuse:

2 C-type MCBs 16A, 3p
 1 RCCB 40/0.03A, 4p

Cable entry at top and bottom:

each with 1x M12, 1x M20, 2x M40

Connection option:

for 2 cables up to 5 x 25 mm²



Technical information

- Ready wired for installation

- Dimension of enclosure: 211 x 116 mm
- Ready wired for installation
- Enclosure made of high-grade, impact-resistant plastic
- Small, compact design
- Variable configuration

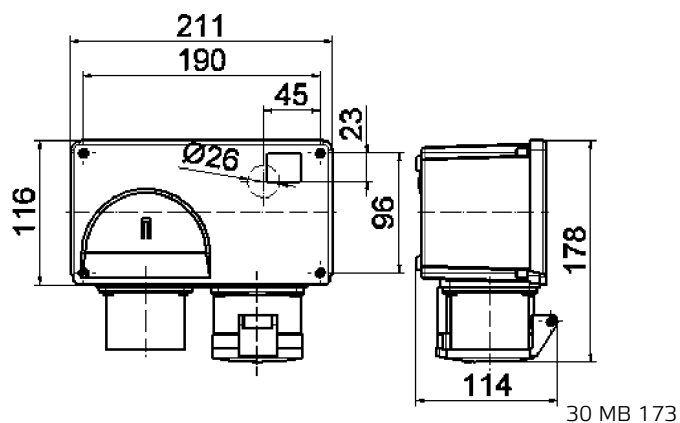

Ref. no. **591**

Components:

1 CEE socket 16A, 400V, 5p

Cable entry:

1 CEE inlet 16A, 400V, 5p



Ref. no. **592**

Components:

1 CEE socket 32A, 400V, 5p

Cable entry:

1 CEE inlet 32A, 400V, 5p



1

2

3

4

5

6

7

8





We live in a fast-moving time. It is also frequently necessary to make modifications to power distribution systems. Power distributors used in industrial buildings, production facilities, laboratories, harbour docks, markets, tunnel, road construction sites and many other locations therefore frequently need to be adapted to their external conditions. In extreme applications, these distribution systems are often exposed to very harsh environmental conditions. That's where the MODBOX® is the ideal solution. The patented MODBOX® Rubber Distributor Series combines all the demands placed on power distributors up to a maximum degree of protection of IP67.

When it comes to toughness, the MODBOX® leaves no wish unfulfilled. The material properties of the MODBOX® are unique: its robustness and resistance to ageing, temperature, oil and acid are unbeatable characteristics that can not be achieved by other

distributor housings. The MODBOX® is, of course, also fully insulated, UV-resistant and halogen-free as well as flame-resistant and self-extinguishing.

The truly innovative enclosure design allows existing installations to be adapted quickly. Order separation attachments are provided in the enclosure. This makes it easier to install strong-current and weak-current systems.

An outstanding feature is that MODBOX® units can be easily connected next to each as modules without any modifications needing to be made to the basic installation.

The MODBOX® is freely configurable. Four openings in the side of the MODBOX® allow modules to be added in any direction. Another feature are the yellow connecting and end corners. To further improve safety, the luminous end corners (luminescence time up to 7 hours) are recommended.

Technical Data

- Maximum Protection degree IP67
- MODBOX MIDI with user-friendly OTC operating window
- Modular expansion on all 4 sides possible
- Yellow end corners for increased safety
- Cover available on request with or without rain roof
- Hard Rubber mixture with hardness grade of 99 shore
- Corners and stability framework are made of cured glass-fibre-reinforced Polyamide
- Outer corners luminous on request
- Fully insulated

Material properties

- Impact-resistant
- UV-resistant
- Halogen-free
- Resistant to ageing, temperature, oil and acid
- Excellent resistance to chemicals
- Flame-resistant, self-extinguishing



Technical information

- Wired ready for connection
- Protection degree IP44
- All distributors comply with the DIN EN 61439 / IEC 61439

- Enclosure made of high-quality, impact-resistant solid rubber
- User-friendly OTC operating window
- Modular extension
- Hardness grade of 99 shore
- Resistant to ageing, temperature, oil and acid
- Excellent resistance to chemicals
- Flame-resistant, self-extinguishing
- Top section straight, CEE sockets angled
- All CEE sockets with screwless, maintenance-free QUICK-CONNECT technology
- Black top and bottom section with yellow end corners

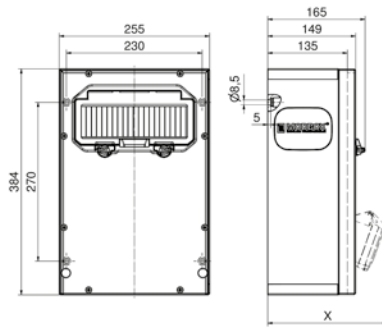

Depth X (mm)

Component	IP44	IP67
OTC operating window	165	165
Domestic socket	152	195
CEE 16A 3p	190	190
CEE 16A 4p	194	192
CEE 16A 5p	197	195
CEE 32A 3p / 4p	201	203
CEE 32A 5p	203	204
CEE 63A 3p / 4p / 5p	219	221

30 MB 218

Ref. no. **5401882**

Components:

3 Domestic sockets 16A, 230V ~
(type F - German standard)

Fuse:

3 C-type MCBs 16A, 1p
1 RCCB 40/0.03A, 4p

Cable entry at top and bottom:

each with 2x M40

Connection option:

for 2 cables up to 5 x 25 mm²

with RCCB B type: 5402775



Ref. no. **5401884**

Components:

6 Domestic sockets 16A, 230V ~
(type F - German standard)

Fuse:

6 C-type MCBs 16A, 1p
1 RCCB 40/0.03A, 4p

Cable entry at top and bottom:

each with 2x M40

Connection option:

for 2 cables up to 5 x 25 mm²

with RCCB B type: 5402776



Ref. no. **5401886**

Components:

2 Domestic sockets 16A, 230V ~
(type F - German standard)
1 CEE socket 16A, 400V, 5p

Fuse:

2 C-type MCBs 16A, 1p
1 C-type MCB 16A, 3p
1 RCCB 40/0.03A, 4p

Cable entry at top and bottom:

each with 2x M40

Connection option:

for 2 cables up to 5 x 25 mm²

with RCCB B type: 5402510



Ref. no. **5401892**

Components:

2 Domestic sockets 16A, 230V ~
(type F - German standard)
1 CEE socket 16A, 400V, 5p
1 CEE socket 32A, 400V, 5p

Fuse:

2 C-type MCBs 16A, 1p
1 C-type MCB 16A, 3p
1 RCCB 40/0.03A, 4p

Cable entry at top and bottom:

each with 2x M40

Connection option:

for 2 cables up to 5 x 25 mm²

with RCCB B type: 5402777



Ref. no. **5401894**

Components:

3 Domestic sockets 16A, 230V ~
(type F - German standard)
2 CEE sockets 16A, 400V, 5p

Fuse:

3 C-type MCBs 16A, 1p
2 C-type MCBs 16A, 3p

Cable entry at top and bottom:

each with 2x M40

Connection option:

for 2 cables up to 5 x 25 mm²



Ref. no. **5402794**

Components:

2 Domestic sockets 16A, 230V ~
(type F - German standard)
1 CEE socket 16A, 400V, 5p
1 CEE socket 32A, 400V, 5p
1 double data socket RJ45 CAT6a IP55

Fuse:

2 C-type MCBs 16A, 1p
1 C-type MCB 16A, 3p
1 RCCB 40/0.03A, 4p

Cable entry at top and bottom:

each with 2 x M20 and 2x M32

Connection option:

for 2 cables up to 5 x 25 mm²

with RCCB B type: 5402797



Technical information

- Wired ready for connection
- Protection degree IP44
- All distributors comply with the DIN EN 61439 / IEC 61439

- Enclosure made of high-quality, impact-resistant solid rubber
- Modular extension
- Hardness grade of 99 shore
- Resistant to ageing, temperature, oil and acid
- Excellent resistance to chemicals
- Flame-resistant, self-extinguishing
- Top section straight, CEE sockets angled
- All CEE sockets with screwless, maintenance-free QUICK-CONNECT technology
- Black top and bottom section with yellow end corners

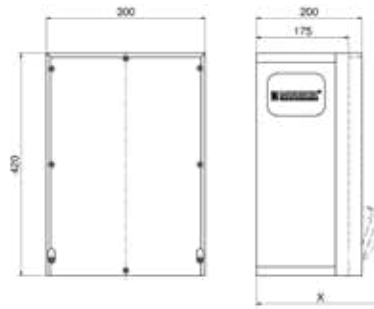

Depth X (mm)

Component	IP44	IP67
Domestic socket	192	235
CEE 16A 3p	230	230
CEE 16A 4p	234	232
CEE 16A 5p	237	235
CEE 32A 3p / 4p	241	243
CEE 32A 5p	243	244
CEE 63A 3p / 4p / 5p	259	261

13 MB 109

Ref. no. **5401455**

Components:

3 Domestic sockets 16A, 230V ~
(type F - German standard)
2 CEE sockets 16A, 400V, 5p

Fuse:

3 C-type MCBs 16A, 1p
2 C-type MCBs 16A, 3p
1 RCCB 40/0.03A, 4p

Cable entry at top and bottom:
each with 2x M40

Connection option:

for 2 cables up to 5 x 25 mm²

with RCCB B type: 5402778



Ref. no. **5401567**

Components:

3 Domestic sockets 16A, 230V ~
(type F - German standard)
2 CEE sockets 32A, 400V, 5p

Fuse:

3 C-type MCBs 16A, 1p
2 C-type MCBs 32A, 3p
1 RCCB 63/0.03A, 4p

Cable entry at top and bottom:
each with 2x M40

Connection option:

for 2 cables up to 5 x 25 mm²

with RCCB B type: 5402779



Ref. no. **5401343**

Components:

3 Domestic sockets 16A, 230V ~
(type F - German standard)
1 CEE socket 16A, 400V, 5p
1 CEE socket 32A, 400V, 5p

Fuse:

3 C-type MCBs 16A, 1p
1 C-type MCB 16A, 3p
1 C-type MCB 32A, 3p
1 RCCB 40/0.03A, 4p

Cable entry at top and bottom:
each with 2x M40

Connection option:

for 2 cables up to 5 x 16 mm²

with RCCB B type: 5402438



Ref. no. **5401668**

Components:

3 Domestic sockets 16A, 230V ~
(type F - German standard)
1 CEE socket 16A, 400V, 5p
1 CEE socket 32A, 400V, 5p

Fuse:

3 Neozed D01, 1p
1 Neozed D01, 3p
1 RCCB 40/0.03A, 4p

Cable entry at top and bottom:
each with 2x M40

Connection option:

for 2 cables up to 5 x 25 mm²

with RCCB B type: 5402780



Ref. no. **5401662**

Components:

3 Domestic sockets 16A, 230V ~
(type F - German standard)
1 CEE socket 16A, 400V, 5p
1 CEE socket 32A, 400V, 5p

Fuse:

3 Neozed D01, 1p
1 Neozed D01, 3p
1 Neozed D02, 3p

Cable entry at top and bottom:
each with 2x M40

Connection option:

for 2 cables up to 5 x 25 mm²



Ref. no. **5402044**

Components:

2 Domestic sockets 16A, 230V ~
(type F - German standard)
2 CEE sockets 32A, 400V, 5p

Fuse:

2 C-type MCBs 16A, 1p
2 C-type MCBs 32A, 3p
1 RCCB 63/0.03A, 4p

Cable entry at top and bottom:
each with 2x M40

Connection option:

for 2 cables up to 5 x 25 mm²

with RCCB B type: 5402781



Technical information

- Wired ready for connection
- Protection degree IP44
- All distributors comply with the DIN EN 61439 / IEC 61439

Ref. no. **5401302**

Components:

- 2 Domestic sockets 16A, 230V ~ (type F - German standard)
- 1 CEE socket 16A, 400V, 5p
- 1 CEE socket 32A, 400V, 5p

Fuse:

- 2 C-type MCBs 16A, 1p
- 1 C-type MCB 16A, 3p
- 1 C-type MCB 32A, 3p
- 1 RCCB 40/0.03A, 4p

Cable entry at top and bottom:

each with 2x M40

Connection option:

for 2 cables up to 5 x 25 mm²

with RCCB B type: 5402511



Ref. no. **5402046**

Components:

- 3 Domestic sockets 16A, 230V ~ (type F - German standard)
- 1 CEE socket 16A, 230V, 3p
- 1 CEE socket 16A, 400V, 5p

Fuse:

- 3 C-type MCBs 16A, 1p
- 1 C-type MCB 16A, 1p
- 1 C-type MCB 16A, 3p
- 1 RCCB 40/0.03A, 4p

Cable entry at top and bottom:

each with 2x M40

Connection option:

for 2 cables up to 5 x 25 mm²

with RCCB B type: 5402782



Ref. no. **5401453**

Components:

- 4 Domestic sockets 16A, 230V ~ (type F - German standard)
- 1 CEE socket 16A, 400V, 5p
- 1 CEE socket 32A, 400V, 5p

Fuse:

- 2 C-type MCBs 16A, 1p
- 1 C-type MCB 16A, 3p
- 1 C-type MCB 32A, 3p
- 1 RCCB 63/0.03A, 4p

Cable entry at top and bottom:

each with 2x M40

Connection option:

for 2 cables up to 5 x 25 mm²

with RCCB B type: 5402783



Ref. no. **5402795**

Components:

- 2 Domestic sockets 16A, 230V ~ (type F - German standard)
- 1 CEE socket 16A, 400V, 5p
- 1 CEE socket 32A, 400V, 5p
- 2 RJ45 CAT6a below operating window

Fuse:

- 2 C-type MCBs 16A, 1p
- 1 C-type MCB 16A, 3p
- 1 C-type MCB 32A, 3p
- 1 RCCB 40/0.03A, 4p

Cable entry at top and bottom:

each with 2x M20 and 2x M40

Connection option:

for 2 cables up to 5 x 25 mm²

with RCCB B type: 5402796



Ref. no. **5402047**

Components:

- 4 Domestic sockets 16A, 230V ~ (type F - German standard)
- 1 CEE socket 16A, 400V, 5p
- 1 CEE socket 32A, 400V, 5p

Fuse:

- 4 C-type MCBs 16A, 1p
- 1 C-type MCB 16A, 3p
- 1 C-type MCB 32A, 3p

Cable entry at top and bottom:

each with 2x M40

Connection option:

for 2 cables up to 5 x 25 mm²



Ref. no. **5401274**

Components:

- 2 Domestic sockets 16A, 230V ~ (type F - German standard)
- 1 CEE socket 16A, 400V, 5p
- 1 CEE socket 32A, 400V, 5p

Fuse:

- 2 C-type MCBs 16A, 1p
- 1 C-type MCB 16A, 3p
- 1 C-type MCB 32A, 3p
- 1 RCCB 63/0.03A, 4p

Cable entry at top and bottom:

each with 2x M40

Connection option:

for 2 cables up to 5 x 25 mm²

with RCCB B type: 5402784



Ref. no. **5402059**

Components:

- 2 Domestic sockets 16A, 230V ~ (type F - German standard)
- 1 CEE socket 16A, 400V, 5p
- 1 CEE socket 32A, 400V, 5p
- 1 double data socket RJ45 CAT6a IP55

Fuse:

- 2 C-type MCBs 16A, 1p
- 1 C-type MCB 16A, 3p
- 1 C-type MCB 32A, 3p
- 1 RCCB 40/0.03A, 4p

Cable entry at top and bottom:

each with 2x M20, 2x M40

Connection option:

for 2 cables up to 5 x 25 mm²

with RCCB B type: 5402785



Ref. no. **5402060**

Components:

- 3 Domestic sockets 16A, 230V ~ (type F - German standard)
- 1 CEE socket 16A, 400V, 5p
- 1 CEE socket 32A, 400V, 5p
- 1 double data socket RJ45 CAT6a IP55

Fuse:

- 3 C-type MCBs 16A, 1p
- 1 C-type MCB 16A, 3p
- 1 C-type MCB 32A, 3p
- 1 RCCB 63/0.03A, 4p

Cable entry at top and bottom:

each with 2x M20, 2x M40

Connection option:

for 2 cables up to 5 x 16 mm²

with RCCB B type: 5402786



Technical information

- Wired ready for connection
- Protection degree IP67
- All distributors comply with the DIN EN 61439 / IEC 61439

Ref. no. **5402159**

Components:

4 Domestic sockets 16A, 230V ~
(type F - German standard)

Fuse:

4 C-type MCBs 16A, 1p
1 RCCB 40/0.03A, 4p

Cable entry at bottom:

1x M12, 2x M40

Connection option:

for 2 cables up to 5 x 25 mm²

with RCCB B type: 5402787



Ref. no. **5402160**

Components:

3 Domestic sockets 16A, 230V ~
(type F - German standard)
1 CEE socket 16A, 400V, 5p

Fuse:

3 C-type MCBs 16A, 1p
1 C-type MCB 16A, 3p
1 RCCB 40/0.03A, 4p

Cable entry at bottom:

1x M12, 2x M40

Connection option:

for 2 cables up to 5 x 25 mm²

with RCCB B type: 5402788



Ref. no. **5402161**

Components:

2 Domestic sockets 16A, 230V ~
(type F - German standard)
2 CEE sockets 16A, 400V, 5p

Fuse:

2 C-type MCBs 16A, 1p
2 C-type MCBs 16A, 3p
1 RCCB 40/0.03A, 4p

Cable entry at bottom:

1x M12, 2x M40

Connection option:

for 2 cables up to 5 x 25 mm²

with RCCB B type: 5402789



Ref. no. **5402162**

Components:

2 Domestic sockets 16A, 230V ~
(type F - German standard)
1 CEE socket 16A, 400V, 5p
1 CEE socket 32A, 400V, 5p

Fuse:

2 C-type MCBs 16A, 1p
1 C-type MCB 16A, 3p
1 C-type MCB 32A, 3p
1 RCCB 40/0.03A, 4p

Cable entry at bottom:

1x M12, 2x M40

Connection option:

for 2 cables up to 5 x 25 mm²

with RCCB B type: 5402618



Ref. no. **5402163**

Components:

2 Domestic sockets 16A, 230V ~
(type F - German standard)
1 CEE socket 16A, 400V, 5p
1 CEE socket 32A, 400V, 5p

Fuse:

2 C-type MCBs 16A, 1p
1 C-type MCB 16A, 3p
1 C-type MCB 32A, 3p
1 RCCB 63/0.03A, 4p

Cable entry at bottom:

1x M12, 2x M40

Connection option:

for 2 cables up to 5 x 25 mm²

with RCCB B type: 5402790



Ref. no. **5402164**

Components:

2 Domestic sockets 16A, 230V ~
(type F - German standard)
2 CEE sockets 32A, 400V, 5p

Fuse:

2 C-type MCBs 16A, 1p
2 C-type MCBs 32A, 3p
1 RCCB 63/0.03A, 4p

Cable entry at bottom:

1x M12, 2x M40

Connection option:

for 2 cables up to 5 x 25 mm²

with RCCB B type: 5402791



Ref. no. **5402165**

Components:

3 Domestic sockets 16A, 230V ~
(type F - German standard)
1 CEE socket 16A, 400V, 5p
1 CEE socket 32A, 400V, 5p

Fuse:

3 C-type MCBs 16A, 1p
1 C-type MCB 16A, 3p
1 C-type MCB 32A, 3p
1 RCCB 63/0.03A, 4p

Cable entry at bottom:

1x M12, 2x M40

Connection option:

for 2 cables up to 5 x 25 mm²

with RCCB B type: 5402565



Ref. no. **5402166**

Components:

3 Domestic sockets 16A, 230V ~
(type F - German standard)
2 CEE sockets 16A, 400V, 5p

Fuse:

3 C-type MCBs 16A, 1p
2 C-type MCBs 16A, 3p
1 RCCB 40/0.03A, 4p

Cable entry at bottom:

1x M12, 2x M40

Connection option:

for 2 cables up to 5 x 25 mm²

with RCCB B type: 5402792



1
2
3
4
5
6
7
8

Combinations

Solid-Rubber distributor, surface mounting

Technical information

- Wired ready for connection
- Protection degree IP44
- All distributors comply with the DIN EN 61439 / IEC 61439

- Enclosure made of high-quality, impact-resistant solid rubber
- Space for up to 18 modules under operating window
- Hardness grade of 97 shore
- Hinged lid
- Resistant to ageing, temperature, oil and acid
- Flame-resistant, self-extinguishing
- All CEE sockets with screwless, maintenance-free QUICK-CONNECT technology

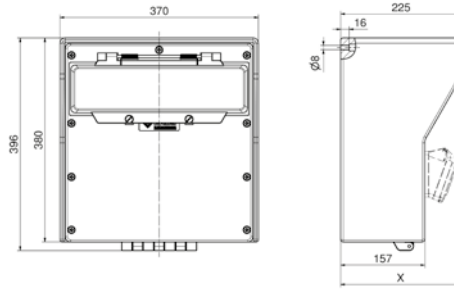

13 MB 117

Depth X (mm)

Component	IP44	IP67	Component	IP44	IP67
Domestic socket	172	215	CEE 32A 3p / 4p	221	223
CEE 16A 3p	210	210	CEE 32A 5p	223	224
CEE 16A 4p	214	212	CEE 63A 3p / 4p / 5p	239	241
CEE 16A 5p	217	215			

Ref. no. **5402049**

Components:

- 4 Domestic sockets 16A, 230V ~ (type F - German standard)
- 2 CEE sockets 16A, 400V, 5p
- 1 CEE socket 32A, 400V, 5p

Fuse:

- 4 C-type MCBs 16A, 1p
- 2 C-type MCBs 16A, 3p
- 1 C-type MCB 32A, 3p
- 1 RCCB 63/0.03A, 4p

Cable entry at top and bottom:
each with 2x M40

Connection option:
for 2 cables up to 5 x 25 mm²

with RCCB B type: 5402633



Ref. no. **5402050**

Components:

- 4 Domestic sockets 16A, 230V ~ (type F - German standard)
- 2 CEE sockets 16A, 400V, 5p
- 1 CEE socket 32A, 400V, 5p

Fuse:

- 4 C-type MCBs 16A, 1p
- 2 C-type MCBs 16A, 3p
- 1 C-type MCB 32A, 3p

Cable entry at top and bottom:
each with 2x M40

Connection option:
for 2 cables up to 5 x 25 mm²



Ref. no. **5402051**

Components:

- 2 Domestic sockets 16A, 230V ~ (type F - German standard)
- 1 CEE socket 16A, 400V, 5p
- 1 CEE socket 32A, 400V, 5p
- 1 CEE socket 63A, 400V, 5p

Fuse:

- 2 C-type MCBs 16A, 1p
- 1 C-type MCB 16A, 3p
- 1 C-type MCB 32A, 3p
- 1 Neozed D02, 3p
- 1 RCCB 63/0.03A, 4p

Cable entry at top and bottom:
each with 2x M40

Connection option:
for 2 cables up to 5 x 25 mm²



Ref. no. **5402052**

Components:

- 4 Domestic sockets 16A, 230V ~ (type F - German standard)
- 1 CEE socket 16A, 400V, 5p
- 1 CEE socket 32A, 400V, 5p
- 1 CEE socket 63A, 400V, 5p

Fuse:

- 4 C-type MCBs 16A, 1p
- 1 C-type MCB 16A, 3p
- 1 C-type MCB 32A, 3p
- 1 RCCB 63/0.03A, 4p

Cable entry at top and bottom:
each with 2x M40

Connection option:
for 2 cables up to 5 x 25 mm²

with RCCB B type: 5402634



Ref. no. **5402053**

Components:

- 4 Domestic sockets 16A, 230V ~ (type F - German standard)
- 1 CEE socket 16A, 400V, 5p
- 1 CEE socket 32A, 400V, 5p
- 1 CEE socket 63A, 400V, 5p

Fuse:

- 4 C-type MCBs 16A, 1p
- 1 C-type MCB 16A, 3p
- 1 C-type MCB 32A, 3p

Cable entry at top and bottom:
each with 2x M40

Connection option:
for 2 cables up to 5 x 25 mm²



Ref. no. **5402054**

Components:

- 2 Domestic sockets 16A, 230V ~ (type F - German standard)
- 1 CEE socket 16A, 400V, 5p
- 1 CEE socket 32A, 400V, 5p
- 1 CEE socket 63A, 400V, 5p

Fuse:

- 2 Neozed D01, 1p
- 1 Neozed D01, 3p
- 2 Neozed D02, 3p

Cable entry at top and bottom:
each with 2x M50

Connection option:
for 2 cables up to 5 x 25 mm²



Technical information

- Ready wired for installation

- Dimension of enclosure: 300 x 300 mm
- Enclosure made of high-quality V2A stainless steel
- Brushed surface
- Door with box lock and single profile cylinder
- Wall mounting brackets, supplied loose
- Brush seal prevents dirt and dust from entering when door is closed
- Lockable in connected state
- Outgoing cables can be guided out through brush-sealed opening on front side
- Easy access to operating elements

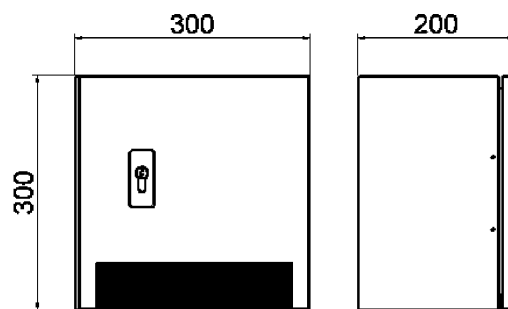

45 MB 50

Ref. no. **560967**

Components:

2 Domestic sockets 16A, 230V ~
(Type F - German standard)
1 CEE socket 16A, 400V, 5p

Cable entry at bottom:

1x M20, 1x M25, 1x M32

Connection option:

for 1 cable 3 x 4 mm² and
1 cable 5 x 4 mm²



Ref. no. **560508**

Components:

1 Domestic socket 16A, 230V ~
(Type F - German standard)
1 CEE socket 16A, 400V, 5p
1 CEE socket 32A, 400V, 5p

Cable entry at bottom:

1x M20, 1x M25, 1x M32

Connection option:

for 1 cable 3 x 4 mm²,
1 cable 5 x 4 mm² and
1 cable 5 x 6 mm²



- Dimension of enclosure: 500 x 420 mm
- Enclosure made of high-quality V2A stainless steel
- Brushed surface
- Door with box lock and single profile cylinder
- Wall mounting brackets, supplied loose
- Brush seal prevents dirt and dust from entering when door is closed
- Lockable in connected state
- Outgoing cables can be guided out through brush-sealed opening on front side
- Easy access to operating elements

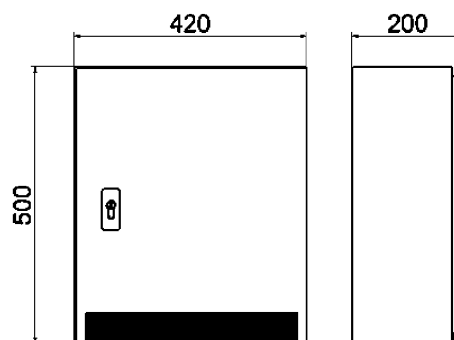

45 MB 17

Ref. no. **560384**

Components:

2 Domestic sockets 16A, 230V ~
(Type F - German standard)
1 CEE socket 16A, 400V, 5p
1 CEE socket 32A, 400V, 5p

Protection:

2 C-type MCBs 16A, 1p
1 C-type MCB 16A, 3p
1 C-type MCB 32A, 3p
1 RCCB 63/0.03A, 4p

Cable entry at bottom:

1x M25, 1x M32, 1x M40

Connection option:

for 2 cables up to 5 x 25 mm²



Ref. no. **562373**

Components:

2 Domestic sockets 16A, 230V ~
(Type F - German standard)
2 CEE sockets 16A, 400V, 5p

Protection:

2 C-type MCBs 16A, 1p
2 C-type MCBs 16A, 3p
1 RCCB 40/0.03A, 4p

Cable entry at bottom:

1x M25, 1x M32, 1x M40

Connection option:

for 2 cables up to 5 x 25 mm²



Combinations

Surface mounting cabinets

Technical information

- Ready wired for installation

- Dimension of enclosure: 700 x 500 mm
- Enclosure made of high-quality V2A stainless steel
- Brushed surface
- Door with box lock and single profile cylinder
- Wall mounting brackets, supplied loose
- Brush seal prevents dirt and dust from entering when door is closed
- Lockable in connected state
- Outgoing cables can be guided out through brush-sealed opening on front side
- Easy access to operating elements

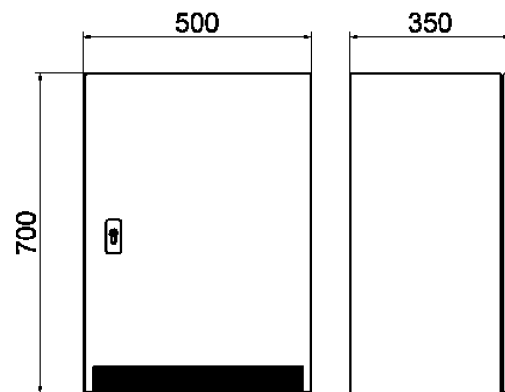

45 MB 45

Ref. no. **562374**

Components:

- 4 Domestic sockets 16A, 230V ~ (Type F - German standard)
- 1 CEE socket 16A, 400V, 5p
- 1 CEE socket 32A, 400V, 5p
- 1 CEE socket 63A, 400V, 5p

Protection:

- 4 C-type MCBs 16A, 1p
- 1 C-type MCB 16A, 3p
- 1 C-type MCB 32A, 3p
- 1 C-type MCB 63A, 3p
- 2 RCCB 63/0.03A, 4p
- 2 fuse bases D02, 3p

Cable entry at bottom:

- 2x M63

Connection option:

- for 2 cables up to 5 x 50 mm²



Ref. no. **562377**

Components:

- 4 Domestic sockets 16A, 230V ~ (Type F - German standard)
- 2 CEE sockets 16A, 400V, 5p
- 2 CEE sockets 32A, 400V, 5p

Protection:

- 4 C-type MCBs 16A, 1p
- 2 C-type MCBs 16A, 3p
- 2 C-type MCBs 32A, 3p
- 1 RCCB 63/0.03A, 4p

Cable entry at bottom:

- 1x M40, 1x M50, 1x M63

Connection option:

- for 2 cables up to 5 x 25 mm²



- Dimension of enclosure: 700 x 530 mm
- Enclosure made of high-quality V2A stainless steel
- Brushed surface
- Door with box lock and single profile cylinder
- Wall mounting brackets, supplied loose
- Brush seal prevents dirt and dust from entering when door is closed
- Lockable in connected state
- Outgoing cables can be guided out through brush-sealed opening on front side
- Easy access to operating elements

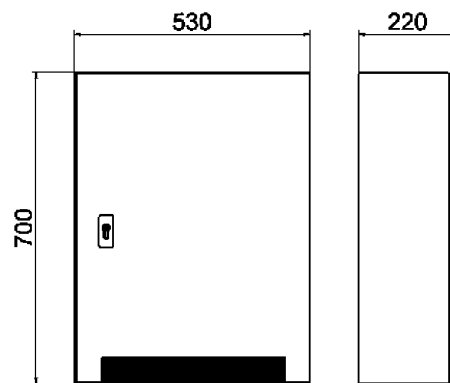

45 MB 29

Ref. no. **561449**

Components:

- 2 Domestic sockets 16A, 230V ~ (Type F - German standard)
- 1 CEE socket 16A, 400V, 5p
- 1 CEE socket 32A, 400V, 5p
- 1 CEE socket 63A, 400V, 5p

Protection:

- 2 C-type MCBs 16A, 1p
- 1 C-type MCB 16A, 3p
- 1 C-type MCB 32A, 3p
- 1 RCCB 63/0.03A, 4p

Cable entry at bottom:

- 1x M32, 1x M40, 1x M50

Connection option:

- for 2 cables up to 5 x 25 mm²



Ref. no. **562306**

Components:

- 4 Domestic sockets 16A, 230V ~ (Type F - German standard)
- 1 CEE socket 16A, 400V, 5p
- 1 CEE socket 32A, 400V, 5p
- 1 CEE socket 63A, 400V, 5p

Protection:

- 4 C-type MCBs 16A, 1p
- 1 C-type MCB 16A, 3p
- 1 C-type MCB 32A, 3p
- 1 RCCB 63/0.03A, 4p

Cable entry at bottom:

- 1x M32, 1x M40, 1x M50

Connection option:

- for 2 cables up to 5 x 25 mm²



- Dimension of enclosure: 300 x 300 mm
- Enclosure made of high-quality V2A stainless steel
- Brushed surface
- Door with box lock and single profile cylinder
- Flush-mount adapter frame
- Brush seal prevents dirt and dust from entering when door is closed
- Outgoing cables can be guided out through brush-sealed opening on front side
- Door lockable in connected state
- Easy access to operating elements

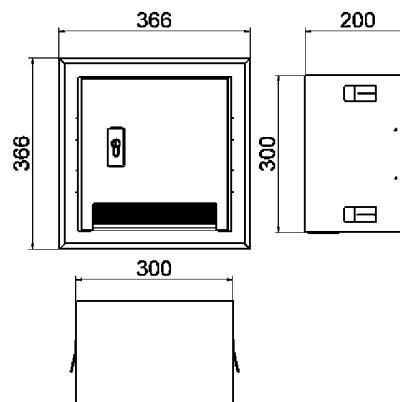

45 MB 51

Ref. no. **560509**

Components:

- 1 Domestic socket 16A, 230V ~ (Type F - German standard)
- 1 CEE socket 16A, 400V, 5p
- 1 CEE socket 32A, 400V, 5p

Cable entry at bottom:

- 1x M20, 1x M25, 1x M32

Connection option:

- for 1 cable up to 3 x 4 mm²,
- 1 cable up to 5 x 4 mm²
- and 1 cable up to 5 x 6 mm²



Ref. no. **560965**

Components:

- 2 Domestic sockets 16A, 230V ~ (Type F - German standard)
- 1 CEE socket 16A, 400V, 5p

Cable entry at bottom:

- 1x M20, 1x M25, 1x M32

Connection option:

- for 1 cable up to 5 x 6 mm²



- Dimension of enclosure: 500 x 420 mm
- Enclosure made of high-quality V2A stainless steel
- Brushed surface
- Door with box lock and single profile cylinder
- Flush-mount adapter frame
- Brush seal prevents dirt and dust from entering when door is closed
- Outgoing cables can be guided out through brush-sealed opening on front side
- Door lockable in connected state
- Easy access to operating elements

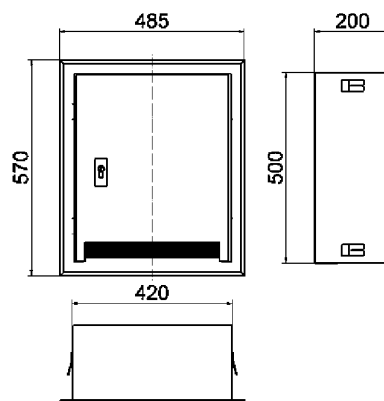

45 MB 21

Ref. no. **561844**

Components:

- 2 Domestic sockets 16A, 230V ~ (Type F - German standard)
- 1 CEE socket 16A, 400V, 5p
- 1 CEE socket 32A, 400V, 5p

Protection:

- 2 C-type MCBs 16A, 1p
- 1 C-type MCB 16A, 3p
- 1 C-type MCB 32A, 3p
- 1 RCCB 63/0.03A, 4p

Cable entry at bottom:

- 1x M25, 1x M32, 1x M40

Connection option:

- for 2 cables up to 5 x 25 mm²



Ref. no. **562379**

Components:

- 2 Domestic sockets 16A, 230V ~ (Type F - German standard)
- 2 CEE sockets 16A, 400V, 5p

Protection:

- 2 C-type MCBs 16A, 1p
- 2 C-type MCBs 16A, 3p
- 1 RCCB 40/0.03A, 4p

Cable entry at bottom:

- 1x M25, 1x M32, 1x M40

Connection option:

- for 2 cables up to 5 x 25 mm²



- Dimension of enclosure: 500 x 220 mm
- Enclosure made of high-quality V2A stainless steel
- Brushed surface
- Door with box lock and single profile cylinder
- Flush-mount adapter frame
- Brush seal prevents dirt and dust from entering when door is closed
- Outgoing cables can be guided out through brush-sealed opening on front side
- Door lockable in connected state
- Easy access to operating elements

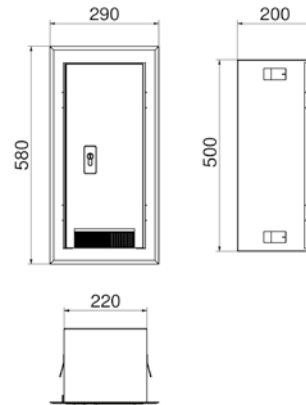

45 MB 68

Ref. no. **561872**

Components:

- 1 Domestic socket 16A, 230V ~ (Type F - German standard)
- 1 CEE socket 16A, 400V, 5p

Protection:

- 1 C-type MCB 16A, 1p
- 1 C-type MCB 16A, 3p
- 1 RCCB 40/0.03A, 4p

Cable entry at bottom:

- 1x M32, 1x M40

Connection option:

- for 2 cables up to 5 x 25 mm²



Ref. no. **562378**

Components:

- 1 Domestic socket 16A, 230V ~ (Type F - German standard)
- 1 CEE socket 32A, 400V, 5p

Protection:

- 1 C-type MCB 16A, 1p
- 1 C-type MCB 32A, 3p
- 1 RCCB 40/0.03A, 4p

Cable entry at bottom:

- 1x M32, 1x M40

Connection option:

- for 2 cables up to 5 x 25 mm²



- Dimension of enclosure: 700 x 500 mm
- Enclosure made of high-quality V2A stainless steel
- Brushed surface
- Door with box lock and single profile cylinder
- Flush-mount adapter frame
- Brush seal prevents dirt and dust from entering when door is closed
- Outgoing cables can be guided out through brush-sealed opening on front side
- Door lockable in connected state
- Easy access to operating elements

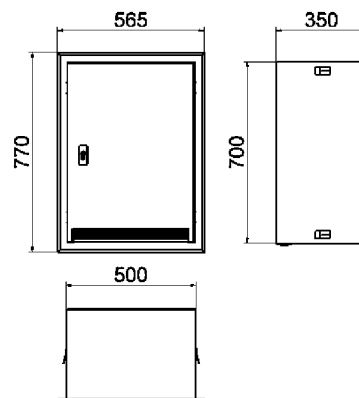

45 MB 46

Ref. no. **562380**

Components:

- 2 Domestic sockets 16A, 230V ~ (Type F - German standard)
- 2 CEE sockets 16A, 400V, 5p
- 1 CEE socket 32A, 400V, 5p
- 1 CEE socket 63A, 400V, 5p

Protection:

- 2 C-type MCBs 16A, 1p
- 2 C-type MCBs 16A, 3p
- 1 C-type MCB 32A, 3p
- 1 RCCB 63/0.03A, 4p

Cable entry at bottom:

- 1x M40, 1x M50, 1x M63

Connection option:

- for 2 cables up to 5 x 25 mm²



Ref. no. **562376**

Components:

- 4 Domestic sockets 16A, 230V ~ (Type F - German standard)
- 2 CEE sockets 16A, 400V, 5p
- 2 CEE sockets 32A, 400V, 5p

Protection:

- 4 C-type MCBs 16A, 1p
- 2 C-type MCBs 16A, 3p
- 2 C-type MCBs 32A, 3p
- 1 RCCB 63/0.03A, 4p

Cable entry at bottom:

- 1x M40, 1x M50, 1x M63

Connection option:

- for 2 cables up to 5 x 25 mm²



1

2

3

4

5

6

7

8

Technical information

- Wired ready for connection
- Protection degree IP44
- All distributors comply with the DIN EN 61439 / IEC 61439

- With high quality handle
- Housing made of high-grade, impact-resistant plastic
- Top and bottom can be sealed together
- Permanently attached cover screws
- Top section straight, CEE sockets angled
- All CEE sockets with screwless, maintenance-free QUICK-CONNECT technology
- Colours: bottom - black, top - electro-grey (housing top optionally available in the colours yellow, red or blue)

Ref. no. **85000**

Components:

3 domestic sockets 16A, 230V (type F - German standard)

Cable entry:

Domestic plug 16A, 230V with 2 m lead H07RN-F3G2,5



Ref. no. **85006**

Components:

2 domestic sockets 16A, 230V (type F - German standard)
1 CEE socket 16A, 400V, 5p

Cable entry:

CEE plug 16A, 400V, 5p with 2 m cable H07RN-F5G2,5



Ref. no. **85007**

Components:

2 domestic sockets 16A, 230V (type F - German standard)
1 CEE socket 16A, 400V, 5p

Fuse:

2 C-type MCBs 16A, 1p
1 C-type MCB 16A, 3p
1 RCCB 40/0.03A, 4p

Cable entry:

CEE plug 32A, 400V, 5p with 2 m cable H07RN-F5G4



Ref. no. **85002**

Components:

3 domestic sockets 16A, 230V (type F - German standard)
2 CEE sockets 16A, 400V, 5p

Cable entry:

CEE plug 16A, 400V, 5p with 2 m cable H07RN-F5G2,5



Ref. no. **85008**

Components:

2 domestic sockets 16A, 230V (type F - German standard)
1 CEE socket 16A, 400V, 5p
1 CEE socket 32A, 400V, 5p

Fuse:

2 C-type MCBs 16A, 1p
1 C-type MCB 16A, 3p
1 RCCB 40/0.03A, 4p

Cable entry:

CEE plug 32A, 400V, 5p with 2 m cable H07RN-F5G6



Ref. no. **85036**

Components:

6 domestic sockets 16A, 230V (type F - German standard)

Fuse:

6 C-type MCBs 16A, 1p
1 RCCB 40/0.03A, 4p

Cable entry:

CEE plug 32A, 400V, 5p with 2 m cable H07RN-F5G4



Technical information

- Wired ready for connection
- Protection degree IP44
- All distributors comply with the DIN EN 61439 / IEC 61439

Ref. no. **85009**

Components:

3 domestic sockets 16A, 230V
(type F - German standard)
1 CEE socket 16A, 400V, 5p
1 CEE socket 32A, 400V, 5p

Fuse:

3 C-type MCBs 16A, 1p
1 C-type MCB 16A, 3p
1 RCCB 40/0.03A, 4p

Cable entry:

CEE plug 32A, 400V, 5p with
2 m cable H07RN-F5G6



Ref. no. **85016**

Components:

3 domestic sockets 16A, 230V
(type F - German standard)
1 CEE socket 16A, 400V, 5p

Fuse:

3 C-type MCBs 16A, 1p
1 C-type MCB 16A, 3p
1 RCCB 40/0.03A, 4p

Cable entry:

CEE plug 32A, 400V, 5p with
2 m cable H07RN-F5G4



Ref. no. **85034**

Components:

4 domestic sockets 16A, 230V
(type F - German standard)
1 CEE socket 16A, 400V, 5p
1 CEE socket 32A, 400V, 5p

Fuse:

4 C-type MCBs 16A, 1p
1 C-type MCB 16A, 3p
1 RCCB 40/0.03A, 4p

Cable entry:

CEE plug 32A, 400V, 5p with
2 m cable H07RN-F5G6



Ref. no. **85005**

Components:

6 domestic sockets 16A, 230V
(type F - German standard)

Fuse:

1 RCCB 40/0.03A, 4p

Cable entry:

CEE plug 16A, 400V, 5p with
2 m cable H07RN-F5G2,5



1

2

3

4

5

6

7

8

The mobile distributor generation

The new EVOBOX series is the ideal solution for mobile power supply in industry, on construction sites or in event technology.

The portable distributor series is available in 4 coordinated housing sizes and impresses with its high mechanical and thermal capacity.

Product information

- Available in 4 coordinated housing sizes
- Perfectly stackable
- Easy-to-handle, using integrated carrying grips
- No protruding components
- fuse elements under transparent operating windows
- Distributor outlets and fuse elements each separately on one side
- Ready wired for installation
- The internal wiring is designed for the highest possible safety via the specification standard
- Resistant to ageing and weather
- Lightweight and impact resistant through the use of hard-polyethylene

Product details

- Impact strength IK10, up to 20J impact energy
- Self-extinguishing and UV-stabilized
- Highly resistant thermally and mechanically
- Maintenance-free QUICK-CONNECT-technology for CEE up to 63A and domestic sockets
- Overall protection degree of the distributor is IP54
- Flexible fitting options up to 125A

Optional

- Adapted arrangement of panel mounting sockets for plugs with protection degree IP67
- Phase control lights are easily visible under operating windows
- External earthing screw outside the housing
- Installation of overvoltage protection
- The housing can be blue, red and orange (minimum order quantity)
- all panel mounting socket outlets are available in black

Power supply

- Cable entry with CEE plug up to max. 125A
- CEE inlet up to max. 125A

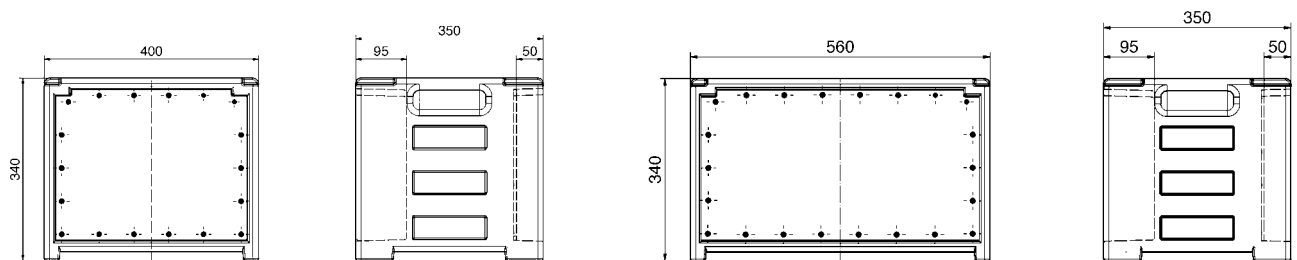

 **EVOBOX-S**

 **EVOBOX-M**



The 4 coordinated housing sizes

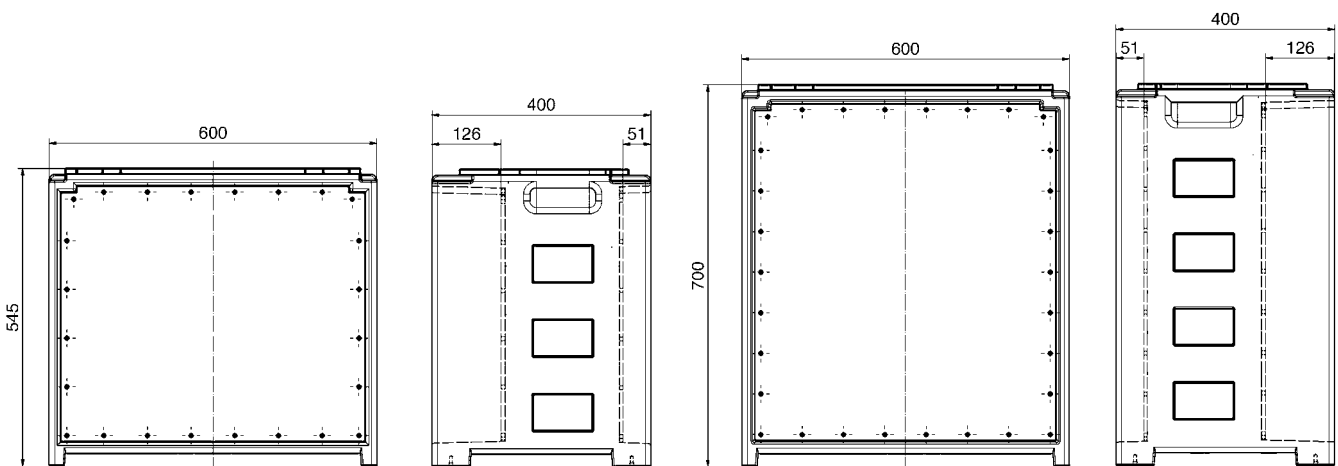

 **EVOBOX-L**

 **EVOBOX-XL**

One distributor - many areas of application

The mobile distributor generation **EVOBOX**, customized, depending on the area of application.

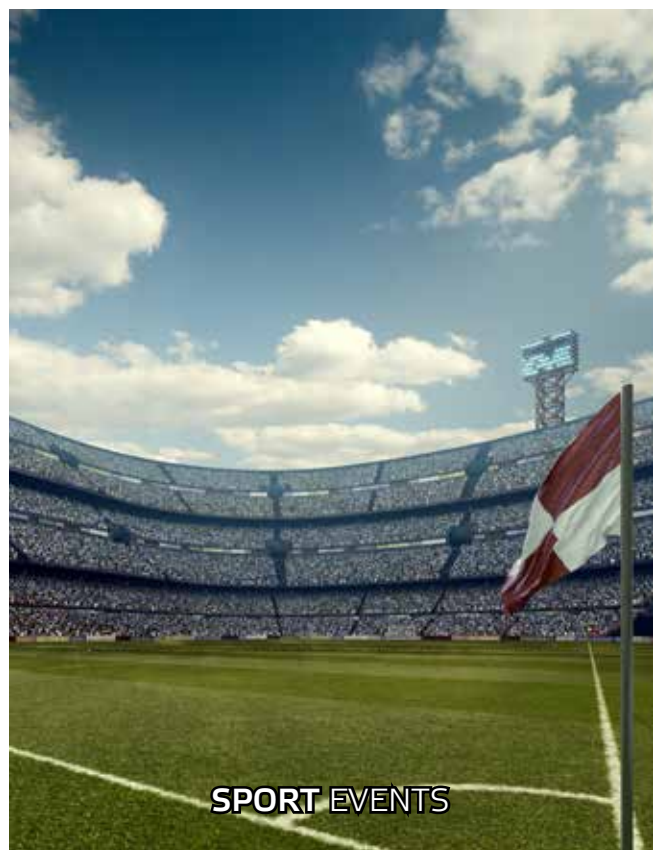

Components:

6 domestic sockets 16A, 230V, IP54
(Type F - German standard)
2 CEE sockets 16A, 400V, 5p, 6h, IP54

Fuse:

6 C-type MCBs 16A, 1p
1 C-type MCB 16A, 3p
1 RCCB 40/0,03A, 4p

Additional equipment:

1 phase control light, LED green
1 external earthing screw

Input:

1 CEE inlet 16A, 400V, 5p, 6h, IP67

Ref. no. **5202999**

 **EVOBOX-S**



1

2

Components:

9 domestic sockets 16A, 230V, IP54
(Type F - German standard)
3 CEE sockets 16A, 400V, 5p, 6h, IP54
1 CEE socket 32A, 400V, 5p, 6h, IP54

Fuse:

9 C-type MCBs 16A, 1p
3 C-type MCBs 16A, 3p
1 RCCB 40/0,03A, 4p

Additional equipment:

1 phase control light, LED green
1 external earthing screw

Input:

1 CEE inlet 32A, 400V, 5p, 6h, IP67

Ref. no. **5203000**

 **EVOBOX-M**



3

4

Components:

9 domestic sockets 16A, 230V, IP54
(Type F - German standard)
4 CEE sockets 16A, 400V, 5p, 6h, IP54
2 CEE sockets 32A, 400V, 5p, 6h, IP54
1 CEE socket 63A, 400V, 5p, 6h, IP67

Fuse:

9 C-type MCBs 16A, 1p
4 C-type MCBs 16A, 3p
2 C-type MCBs 32A, 3p
3 RCCBs 63/0,03A, 4p

Additional equipment:

1 phase control light, LED green
1 external earthing screw

Input:

1 CEE inlet 63A, 400V, 5p, 6h, IP67

Ref. no. **5203001**

 **EVOBOX-L**



5

6

Components:

9 domestic sockets 16A, 230V, IP54
(Type F - German standard)
4 CEE sockets 16A, 400V, 5p, 6h, IP54
4 CEE sockets 32A, 400V, 5p, 6h, IP54
2 CEE sockets 63A, 400V, 5p, 6h, IP67
1 CEE socket 125A, 400V, 5p, 6h, IP67

Fuse:

9 C-type MCBs 16A, 1p
4 C-type MCBs 16A, 3p
4 C-type MCBs 32A, 3p
4 RCCBs 63/0,03A, 4p

4 C-type MCBs 16A, 3p
2 C-type MCBs 63A, 3p
2 RCCBs 63/0,5A, 4p

Additional equipment:

1 phase control light, LED green
1 external earthing screw

Input:

1 CEE inlet 125A, 400V, 5p, 6h, IP67

Ref. no. **5203002**

 **EVOBOX-XL**



7

8

Combinations

Solid-Rubber distributor, portable

Technical information

- Wired ready for connection
- Protection degree IP44
- All distributors comply with the DIN EN 61439 / IEC 61439

- Enclosure made of high-quality, impact-resistant solid rubber
- Small, compact design
- Top and bottom in signal yellow
- Handle made of stainless steel

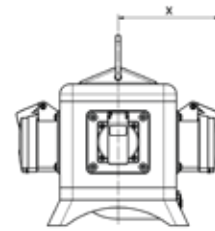
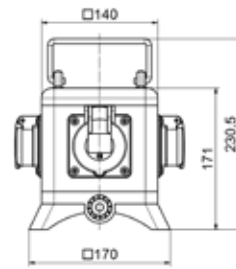

13 MB 123

Depth X (in mm)

Component	IP44	IP67
Operating window	90	
Domestic socket	98,5	114
CEE 16A 3p	121	127
CEE 16A 4p	123	128

Component	IP44	IP67
CEE 16A 5p	127	130
CEE 32A 3p / 4p	130	135
CEE 32A 5p	139	139

Ref. no. **576086**

Components:

- 1 CEE socket 16A, 400V, 5p
- 1 electricity meter 10/65A

Cable entry/inlet:

- CEE plug 16A, 400V, 5p with lead 2 m H07RN-F5G1,5



Ref. no. **57148**

Components:

- 2 Domestic sockets 16A, 230V ~ (type F - German standard)
- 2 CEE sockets 16A, 400V, 5p

Cable entry/inlet:

- CEE plug 16A, 400V, 5p with lead 2 m H07RN-F5G2,5



Ref. no. **57623**

Components:

- 4 Domestic sockets 16A, 230V ~ (type F - German standard)

Cable entry/inlet:

- Domestic plug 16A, 230V, 3p
- 4 m cable H07RN-F3G2,5



Ref. no. **57996**

Components:

- 2 Domestic sockets 16A, 230V ~ (type F - German standard)
- 1 CEE socket 16A, 400V, 5p
- 1 rotary field measuring device

Fuse:

- 1 RCCB 40/0.03A, 4p

Cable entry/inlet:

- CEE phase inverter 16A, 400V, 5p with lead 2 m H07RN-F5G2,5

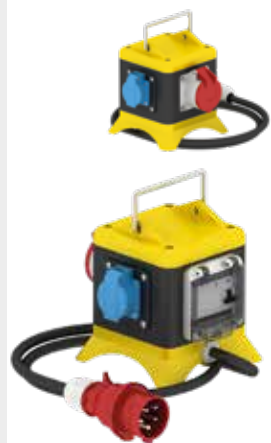

Ref. no. **57255**

Components:

- 2 Domestic sockets 16A, 230V ~ (type F - German standard)
- 1 CEE socket 16A, 400V, 5p

Fuse:

- 1 RCCB 40/0.03A, 4p

Cable entry/inlet:

- CEE plug 16A, 400V, 5p with lead 2 m H07RN-F5G2,5



Ref. no. **57143**

Components:

- 3 Domestic sockets 16A, 230V ~ (type F - German standard)
- 1 CEE socket 16A, 400V, 5p

Cable entry/inlet:

- CEE plug 16A, 400V, 5p with lead 2 m H07RN-F5G2,5



Technical information

- Wired ready for connection
- Protection degree IP44
- All distributors comply with the DIN EN 61439 / IEC 61439

- Enclosure made of high-quality, impact-resistant solid rubber
- Ideally suited to tough, harsh and difficult conditions
- Convenient and compact design
- With moulded carrying handle

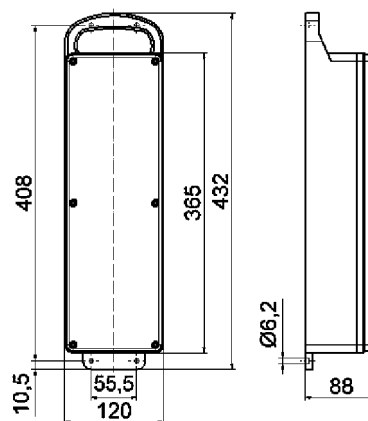

13 MB 7

Ref. no. **530179**

Components:

- 1 Domestic socket 16A, 230V ~ (type F - German standard)
- 1 CEE socket 16A, 400V, 5p
- 1 CEE socket 32A, 400V, 5p

Fuse:

- 1 C-type MCB 16A, 1p
- 1 C-type MCB 16A, 3p

Cable entry/inlet:

CEE plug 32A, 400V, 5p with lead 1.8 m H07RN-F5G4



Ref. no. **5310**

Components:

- 3 CEE sockets 16A, 400V, 5p

Cable entry/inlet:

CEE plug 16A, 400V, 5p with lead 1.8 m H07RN-F5G2,5



Ref. no. **53141**

Components:

- 4 Domestic sockets 16A, 230V ~ (type F - German standard)

Fuse:

- 1 RCCB 25/0.03A, 2p

Cable entry/inlet:

Domestic plug 16A, 230V, 3p with 2 m lead H07RN-F3G2,5



Ref. no. **53525**

Components:

- 3 CEE sockets 32A, 400V, 5p

Cable entry/inlet:

CEE plug 32A, 400V, 5p with lead 2 m H07RN-F5G4



Ref. no. **53420**

Components:

- 2 CEE sockets 16A, 400V, 5p

Fuse:

- 2 C-type MCBs 16A, 3p

Cable entry/inlet:

CEE plug 32A, 400V, 5p with lead 2 m H07RN-F5G6



Ref. no. **53290**

Components:

- 4 Domestic sockets 16A, 230V ~ (type F - German standard)
- 1 CEE socket 16A, 400V, 5p

Cable entry/inlet:

CEE plug 16A, 400V, 5p with lead 2 m H07RN-F5G2,5



1

2

3

4

5

6

7

8

Combinations

Solid-Rubber distributor, portable

Technical information

- Wired ready for connection
- Protection degree IP44
- All distributors comply with the DIN EN 61439 / IEC 61439

Ref. no. **530003**

Components:

2 Domestic sockets 16A, 230V ~
(type F - German standard)
1 CEE socket 16A, 400V, 5p

Fuse:

2 C-type MCBs 16A, 1p
1 RCCB 40/0.03A, 4p

Cable entry/inlet:

CEE plug 16A, 400V, 5p with
lead 2 m H07RN-F5G2,5



Ref. no. **530**

Components:

2 Domestic sockets 16A, 230V ~
(type F - German standard)
1 CEE socket 16A, 400V, 5p

Fuse:

1 RCCB 40/0.03A, 4p

Cable entry/inlet:

CEE plug 16A, 400V, 5p with
lead 1.8 m H07RN-F5G2,5



Ref. no. **5311**

Components:

2 Domestic sockets 16A, 230V ~
(type F - German standard)
1 CEE socket 16A, 400V, 5p

Cable entry/inlet:

CEE plug 16A, 400V, 5p with
lead 1.8 m H07RN-F5G2,5



Ref. no. **5350**

Components:

3 Domestic sockets 16A, 230V ~
(type F - German standard)

Cable entry/inlet:

Domestic plug 16A, 230V, 3p
with 2 m cable H07RN-F3G2,5



Ref. no. **53247**

Components:

6 Domestic sockets 16A, 230V ~
(type F - German standard)

Cable entry/inlet:

CEE plug 16A, 400V, 5p with
lead 2 m H07RN-F5G2,5



Ref. no. **53213**

Components:

4 Domestic sockets 16A, 230V ~
(type F - German standard)

Fuse:

1 RCCB 40/0.03A, 4p

Cable entry/inlet:

CEE plug 16A, 400V, 5p with
lead 2 m H07RN-F5G2,5



Ref. no. **5321**

Components:

3 Domestic sockets 16A, 230V ~
(type F - German standard)

Fuse:

1 RCCB 40/0.03A, 4p

Cable entry/inlet:

CEE plug 16A, 400V, 5p with
lead 2 m H07RN-F5G2,5



Ref. no. **530321**

Components:

3 CEE sockets 16A, 400V, 5p

Fuse:

1 RCCB 40/0.03A, 4p

Cable entry/inlet:

CEE plug 16A, 400V, 5p with
lead 2 m H07RN-F5G2,5



Technical information

- Wired ready for connection
- Protection degree IP44
- All distributors comply with the DIN EN 61439 / IEC 61439

- Enclosure made of high-quality, impact-resistant solid rubber
- Ideally suited to tough, harsh and difficult conditions
- Convenient and compact design
- With moulded carrying handle

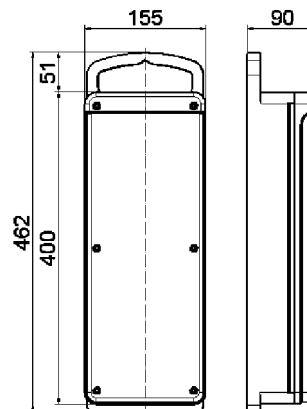

13 MB 54

Ref. no. **53909**

Components:

6 Domestic sockets 16A, 230V ~
(type F - German standard)

Fuse:

3 C-type MCBs 16A, 1p
1 RCCB 40/0.03A, 4p

Cable entry/inlet:

CEE plug 32A, 400V, 5p with
lead 2 m H07RN-F5G4



Ref. no. **53681**

Components:

6 Domestic sockets 16A, 230V ~
(type F - German standard)
1 CEE socket 16A, 400V, 5p

Fuse:

1 RCCB 40/0.03A, 4p

Cable entry/inlet:

CEE plug 16A, 400V, 5p with
lead 2 m H07RN-F5G2,5



Ref. no. **53679**

Components:

12 Domestic sockets 16A, 230V ~
(type F - German standard)

Cable entry/inlet:

CEE plug 16A, 400V, 5p with
lead 2 m H07RN-F5G2,5

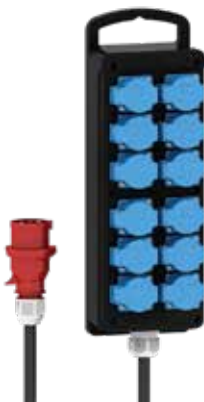

Ref. no. **530090**

Components:

6 Domestic sockets 16A, 230V ~
(type F - German standard)
1 CEE socket 32A, 400V, 5p

Fuse:

3 C-type MCBs 16A, 1p
1 RCCB 40/0.03A, 4p

Cable entry/inlet:

CEE plug 32A, 400V, 5p with
lead 2 m H07RN-F5G4



Ref. no. **530425**

Components:

6 Domestic sockets 16A, 230V ~
(type F - German standard)
1 CEE socket 16A, 400V, 5p

Fuse:

3 C-type MCBs 16A, 1p
1 RCCB 40/0.03A, 4p

Cable entry/inlet:

CEE plug 16A, 400V, 5p with
lead 2 m H07RN-F5G2,5



Ref. no. **530426**

Components:

2 Domestic sockets 16A, 230V ~
(type F - German standard)
1 CEE socket 16A, 400V, 5p
1 CEE socket 32A, 400V, 5p

Fuse:

2 C-type MCBs 16A, 1p
1 C-type MCB 16A, 3p

Cable entry/inlet:

CEE plug 32A, 400V, 5p with
lead 2 m H07RN-F5G4



Combinations

Solid-Rubber distributor, portable

Technical information

- Wired ready for connection
- Protection degree IP44
- All distributors comply with the DIN EN 61439 / IEC 61439

- Enclosure made of high-quality, impact-resistant solid rubber
- Ideally suited to tough, harsh and difficult conditions
- Robust solid-rubber handle with hook for cable
- Lockable stainless-steel quick-release fasteners
- Hinged lid, user-friendly access to protective equipment
- Stackable, foot attachment on enclosure cover
- High rubber feet to avoid dirt at floor level

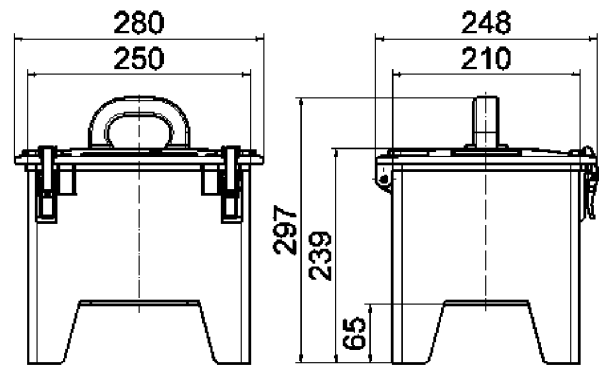

13 MB 43

Ref. no. **5226**

Components:

- 4 Domestic sockets 16A, 230V ~ (type F - German standard)
- 2 CEE sockets 16A, 400V, 5p
- 1 CEE socket 32A, 400V, 5p

Fuse:

- 2 Neozed D01, 1p
- 2 Neozed D01, 3p

Cable entry/inlet:

- CEE inlet 32A, 400V, 5p



Ref. no. **522590**

Components:

- 6 Domestic sockets 16A, 230V ~ (type F - German standard)
- 2 CEE sockets 16A, 400V, 5p
- 1 CEE socket 32A, 400V, 5p
- 1 rotary field measuring device

Fuse:

- 3 C-type MCBs 16A, 1p
- 1 C-type MCB 16A, 3p
- 1 RCCB 40/0.03A, 4p

Cable entry/inlet:

- CEE phase inverter 32A, 400V, 5p



Ref. no. **5201558**

Components:

- 3 Domestic sockets 16A, 230V ~ (type F - German standard)
- 2 CEE sockets 16A, 400V, 5p
- 1 CEE socket 32A, 400V, 5p

Fuse:

- 3 C-type MCBs 16A, 1p
- 1 C-type MCB 16A, 3p
- 1 RCCB 40/0.03A, 4p

Cable entry/inlet:

- CEE inlet 32A, 400V, 5p



Ref. no. **5201047**

Components:

- 4 Domestic sockets 16A, 230V ~ (type F - German standard)
- 2 CEE sockets 16A, 400V, 5p
- 1 CEE socket 32A, 400V, 5p

Fuse:

- 4 C-type MCBs 16A, 1p
- 2 C-type MCBs 16A, 3p
- 1 RCCB 40/0.03A, 4p

Cable entry/inlet:

- CEE inlet 32A, 400V, 5p



Ref. no. **522144**

Components:

- 2 Domestic sockets 16A, 230V ~ (type F - German standard)
- 2 CEE sockets 16A, 400V, 5p
- 2 CEE sockets 32A, 400V, 5p

Fuse:

- 1 Neozed D01, 1p
- 1 Neozed D01, 3p

Cable entry/inlet:

- CEE inlet 32A, 400V, 5p



Ref. no. **5201015**

Components:

- 4 Domestic sockets 16A, 230V ~ (type F - German standard)
- 1 CEE socket 16A, 400V, 5p
- 1 CEE socket 32A, 400V, 5p

Fuse:

- 2 C-type MCBs 16A, 1p
- 1 C-type MCB 16A, 3p
- 1 RCCB 40/0.03A, 4p

Cable entry/inlet:

- CEE plug 32A, 400V, 5p with lead 2 m H07RN-F5G4



Technical information

- Wired ready for connection
- Protection degree IP44
- All distributors comply with the DIN EN 61439 / IEC 61439

Ref. no. **5201926**

Components:

- 4 Domestic sockets 16A, 230V ~ (type F - German standard)
- 1 CEE socket 16A, 400V, 5p
- 2 CEE sockets 32A, 400V, 5p

Fuse:

- 2 C-type MCBs 16A, 1p
- 1 C-type MCB 16A, 3p
- 1 RCCB 40/0.03A, 4p

Cable entry/inlet:

- CEE plug 32A, 400V, 5p with 3 m cable H07RN-F5G6



Ref. no. **5202236**

Components:

- 3 Domestic sockets 16A, 230V ~ (type F - German standard)
- 2 CEE sockets 16A, 400V, 5p
- 2 CEE sockets 32A, 400V, 5p

Fuse:

- 3 C-type MCBs 16A, 1p
- 2 C-type MCBs 16A, 3p
- 1 RCCB 40/0.03A, 4p

Cable entry/inlet:

- CEE inlet 32A, 400V, 5p



Ref. no. **5200568**

Components:

- 3 Domestic sockets 16A, 230V ~ (type F - German standard)
- 3 CEE sockets 32A, 400V, 5p

Fuse:

- 3 C-type MCBs 16A, 1p
- 1 RCCB 40/0.03A, 4p

Cable entry/inlet:

- CEE inlet 32A, 400V, 5p



Ref. no. **524449**

Components:

- 4 Domestic sockets 16A, 230V ~ (type F - German standard)
- 2 CEE sockets 32A, 400V, 5p

Fuse:

- 4 C-type MCBs 16A, 1p

Cable entry/inlet:

- CEE inlet 32A, 400V, 5p



Ref. no. **5225**

Components:

- 4 Domestic sockets 16A, 230V ~ (type F - German standard)
- 2 CEE sockets 16A, 400V, 5p

Cable entry/inlet:

- CEE inlet 16A, 400V, 5p



Ref. no. **5201004**

Components:

- 3 Domestic sockets 16A, 230V ~ (type F - German standard)
- 1 CEE socket 16A, 400V, 5p
- 2 CEE sockets 32A, 400V, 5p

Fuse:

- 3 C-type MCBs 16A, 1p
- 1 C-type MCB 16A, 3p
- 1 RCCB 40/0.03A, 4p

Cable entry/inlet:

- CEE inlet 32A, 400V, 5p



Ref. no. **5200917**

Components:

- 4 Domestic sockets 16A, 230V ~ (type F - German standard)
- 1 CEE socket 16A, 400V, 5p
- 1 CEE socket 32A, 400V, 5p

Fuse:

- 2 C-type MCBs 16A, 1p
- 1 C-type MCB 16A, 3p
- 1 RCCB 40/0.03A, 4p

Cable entry/inlet:

- CEE inlet 32A, 400V, 5p



Ref. no. **5202237**

Components:

- 3 Domestic sockets 16A, 230V ~ (type F - German standard)
- 2 CEE sockets 16A, 400V, 5p
- 1 CEE socket 32A, 400V, 5p

Fuse:

- 3 C-type MCBs 16A, 1p
- 1 C-type MCB 16A, 3p
- 1 RCCB 40/0.03A, 4p

Cable entry/inlet:

- CEE plug 32A, 400V, 5p with lead 3 m H07RN-F5G4



Combinations

Solid-Rubber distributor, portable

Technical information

- Wired ready for connection
- Protection degree IP44
- All distributors comply with the DIN EN 61439 / IEC 61439

Ref. no. **526**

Components:

5 Domestic sockets 16A, 230V ~
(type F - German standard)
2 CEE sockets 16A, 400V, 5p

Cable entry/inlet:

CEE inlet 16A, 400V, 5p



Ref. no. **5202238**

Components:

4 Domestic sockets 16A, 230V ~
(type F - German standard)
1 CEE socket 16A, 400V, 5p
2 CEE sockets 32A, 400V, 5p

Fuse:

4 C-type MCBs 16A, 1p
1 C-type MCB 16A, 3p
1 RCCB 40/0.03A, 4p

Cable entry/inlet:

CEE inlet 32A, 400V, 5p



Ref. no. **522143**

Components:

3 Domestic sockets 16A, 230V ~
(type F - German standard)
2 CEE sockets 16A, 400V, 5p
1 CEE socket 32A, 400V, 5p

Fuse:

3 Neozed D01, 1p
1 Neozed D01, 3p
1 RCCB 40/0.03A, 4p

Cable entry/inlet:

CEE inlet 32A, 400V, 5p



Ref. no. **52638**

Components:

4 Domestic sockets 16A, 230V ~
(type F - German standard)
2 CEE sockets 16A, 400V, 5p

Fuse:

1 RCCB 40/0.03A, 4p

Cable entry/inlet:

CEE plug 16A, 400V, 5p with
lead 2 m H07RN-F5G2,5



Ref. no. **5201555**

Components:

3 Domestic sockets 16A, 230V ~
(type F - German standard)
1 CEE socket 16A, 400V, 5p
1 CEE socket 32A, 400V, 5p

Fuse:

3 C-type MCBs 16A, 1p
1 C-type MCB 16A, 3p
1 RCCB 40/0.03A, 4p

Cable entry/inlet:

CEE inlet 32A, 400V, 5p



Ref. no. **52480**

Components:

4 Domestic sockets 16A, 230V ~
(type F - German standard)
2 CEE sockets 16A, 400V, 5p

Fuse:

1 RCCB 40/0.03A, 4p

Cable entry/inlet:

CEE inlet 16A, 400V, 5p



Ref. no. **522589**

Components:

6 Domestic sockets 16A, 230V ~
(type F - German standard)
2 CEE sockets 16A, 400V, 5p
1 rotary field measuring device

Fuse:

3 C-type MCBs 16A, 1p
1 RCCB 40/0.03A, 4p

Cable entry/inlet:

CEE phase inverter 16A, 400V, 5p



Ref. no. **523291**

Components:

6 Domestic sockets 16A, 230V ~
(type F - German standard)

Fuse:

6 C-type MCBs 16A, 1p
1 RCCB 40/0.03A, 4p

Cable entry/inlet:

CEE plug 32A, 400V, 5p with
lead 3 m H07RN-F5G4



Technical information

- Wired ready for connection
- Protection degree IP44
- All distributors comply with the DIN EN 61439 / IEC 61439

- Enclosure made of high-quality, impact-resistant solid rubber
- Ideally suited to tough, harsh and difficult conditions
- Robust solid-rubber handle with hook for cable
- Lockable stainless-steel quick-release fasteners
- Hinged lid, user-friendly access to protective equipment
- Stackable, foot attachment on enclosure cover
- High rubber feet to avoid dirt at floor level

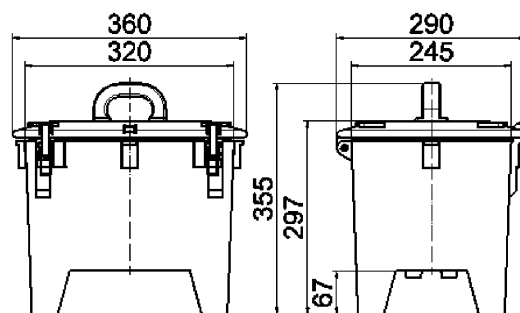

13 MB 36

Ref. no. **5202239**

Components:

- 4 Domestic sockets 16A, 230V ~ (type F - German standard)
- 2 CEE sockets 16A, 400V, 5p
- 2 CEE sockets 32A, 400V, 5p

Fuse:

- 4 C-type MCBs 16A, 1p
- 2 C-type MCBs 16A, 3p
- 2 C-type MCBs 32A, 3p
- 1 RCCB 63/0.03A, 4p

Cable entry/inlet:

- CEE plug 63A, 400V, 5p with lead 2 m H07RN-F5G10



Ref. no. **5202240**

Components:

- 4 Domestic sockets 16A, 230V ~ (type F - German standard)
- 1 CEE socket 16A, 400V, 5p
- 1 CEE socket 32A, 400V, 5p
- 1 CEE socket 63A, 400V, 5p

Fuse:

- 2 C-type MCBs 16A, 1p
- 1 C-type MCB 16A, 3p
- 1 C-type MCB 32A, 3p
- 1 RCCB 63/0.03A, 4p

Cable entry/inlet:

- CEE plug 63A, 400V, 5p with lead 3 m H07RN-F5G10



Ref. no. **524443**

Components:

- 4 Domestic sockets 16A, 230V ~ (type F - German standard)
- 3 CEE sockets 16A, 400V, 5p
- 1 CEE socket 32A, 400V, 5p

Fuse:

- 2 Neozed D01, 1p
- 3 Neozed D01, 3p

Cable entry/inlet:

- CEE plug 32A, 400V, 5p with lead 3 m H07RN-F5G4



Ref. no. **522167**

Components:

- 4 Domestic sockets 16A, 230V ~ (type F - German standard)
- 3 CEE sockets 16A, 400V, 5p
- 1 CEE socket 32A, 400V, 5p

Fuse:

- 2 Neozed D01, 1p
- 3 Neozed D01, 3p

Cable entry/inlet:

- CEE inlet 32A, 400V, 5p



Ref. no. **521828**

Components:

- 4 Domestic sockets 16A, 230V ~ (type F - German standard)
- 4 CEE sockets 32A, 400V, 5p

Fuse:

- 4 Neozed D01, 1p
- 1 RCCB 40/0.03A, 4p

Cable entry/inlet:

- CEE inlet 32A, 400V, 5p



Ref. no. **5202241**

Components:

- 4 Domestic sockets 16A, 230V ~ (type F - German standard)
- 1 CEE socket 16A, 400V, 5p
- 1 CEE socket 32A, 400V, 5p
- 1 CEE socket 63A, 400V, 5p

Fuse:

- 2 C-type MCBs 16A, 1p
- 1 C-type MCB 16A, 3p
- 1 C-type MCB 32A, 3p
- 1 RCCB 63/0.03A, 4p

Cable entry/inlet:

- CEE inlet 63A, 400V, 5p



Combinations

Solid-Rubber distributor, portable

Technical information

- Wired ready for connection
- Protection degree IP44
- All distributors comply with the DIN EN 61439 / IEC 61439

Ref. no. **524446**

Components:

- 4 Domestic sockets 16A, 230V ~ (type F - German standard)
- 1 CEE socket 16A, 400V, 5p
- 1 CEE socket 32A, 400V, 5p
- 1 CEE socket 63A, 400V, 5p

Fuse:

- 2 Neozed D01, 1p
- 1 Neozed D01, 3p
- 1 Neozed D02, 3p
- 1 RCCB 63/0.03A, 4p

Cable entry/inlet:

- CEE plug 63A, 400V, 5p with lead 3 m H07RN-F5G10



Ref. no. **5202242**

Components:

- 6 Domestic sockets 16A, 230V ~ (type F - German standard)
- 1 CEE socket 16A, 400V, 5p
- 1 CEE socket 32A, 400V, 5p
- 1 CEE socket 63A, 400V, 5p

Fuse:

- 6 C-type MCBs 16A, 1p
- 1 C-type MCB 16A, 3p
- 1 C-type MCB 32A, 3p
- 1 RCCB 63/0.03A, 4p

Cable entry/inlet:

- CEE plug 63A, 400V, 5p with lead 2 m H07RN-F5G16



Ref. no. **5202469**

Components:

- 6 Domestic sockets 16A, 230V ~ (type F - German standard)
- 1 CEE socket 16A, 400V, 5p
- 1 CEE socket 32A, 400V, 5p
- 1 CEE socket 63A, 400V, 5p

Fuse:

- 6 C-type MCBs 16A, 1p
- 1 C-type MCB 16A, 3p
- 1 C-type MCB 32A, 3p
- 1 RCCB 63/0.03A, 4p

Cable entry/inlet:

- CEE inlet 63A, 400V, 5p



Ref. no. **5202243**

Components:

- 8 Domestic sockets 16A, 230V ~ (type F - German standard)
- 1 CEE socket 16A, 400V, 5p
- 1 CEE socket 32A, 400V, 5p

Fuse:

- 4 C-type MCBs 16A, 1p
- 1 C-type MCB 16A, 3p
- 1 RCCB 40/0.03A, 4p

Cable entry/inlet:

- CEE plug 32A, 400V, 5p with lead 3 m H07RN-F5G4



Ref. no. **5202244**

Components:

- 8 Domestic sockets 16A, 230V ~ (type F - German standard)
- 1 CEE socket 16A, 400V, 5p
- 1 CEE socket 32A, 400V, 5p

Fuse:

- 4 C-type MCBs 16A, 1p
- 1 C-type MCB 16A, 3p
- 1 RCCB 40/0.03A, 4p

Cable entry/inlet:

- CEE inlet 32A, 400V, 5p



Ref. no. **5201003**

Components:

- 3 Domestic sockets 16A, 230V ~ (type F - German standard)
- 1 CEE socket 16A, 400V, 5p
- 2 CEE sockets 32A, 400V, 5p
- 1 CEE socket 63A, 400V, 5p

Fuse:

- 3 C-type MCBs 16A, 1p
- 1 C-type MCB 16A, 3p
- 2 C-type MCBs 32A, 3p
- 1 RCCB 63/0.03A, 4p

Cable entry/inlet:

- CEE inlet 63A, 400V, 5p



Ref. no. **5202245**

Components:

- 4 Domestic sockets 16A, 230V ~ (type F - German standard)
- 2 CEE sockets 16A, 400V, 5p
- 2 CEE sockets 32A, 400V, 5p

Fuse:

- 2 C-type MCBs 16A, 1p
- 2 C-type MCBs 16A, 3p
- 2 C-type MCBs 32A, 3p
- 1 RCCB 63/0.03A, 4p

Cable entry/inlet:

- CEE plug 63A, 400V, 5p with lead 3 m H07RN-F5G10



Ref. no. **5202470**

Components:

- 4 Domestic sockets 16A, 230V ~ (type F - German standard)
- 2 CEE sockets 16A, 400V, 5p
- 2 CEE sockets 32A, 400V, 5p

Fuse:

- 2 C-type MCBs 16A, 1p
- 2 C-type MCBs 16A, 3p
- 2 C-type MCBs 32A, 3p
- 1 RCCB 63/0.03A, 4p

Cable entry/inlet:

- CEE inlet 63A, 400V, 5p



Technical information

- Wired ready for connection
- Protection degree IP44
- All distributors comply with the DIN EN 61439 / IEC 61439

- Enclosure made of high-grade, impact-resistant plastic
- Hinged window can optional be locked and lead-sealed
- 9 modules can be installed on each enclosure side
- Hinged lid
- Handle bracket in signal yellow

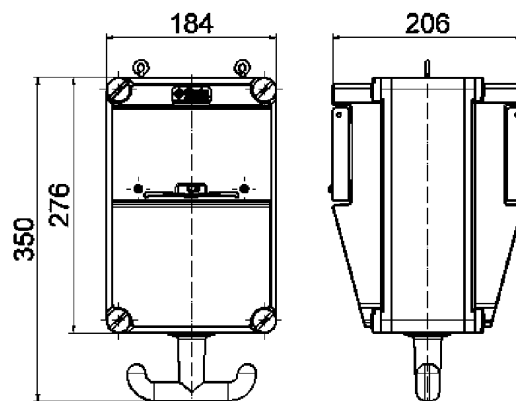

30 MB 186

Ref. no. **572567**

Components:

- 2 Domestic sockets 16A, 230V ~ (type F - German standard)
- 2 CEE sockets 16A, 400V, 5p

Protection:

- 2 C-type MCBs 16A, 1p
- 2 C-type MCBs 16A, 3p
- 1 RCCB 40/0.03A, 4p

Cable entry:

- 1x M40

Connection option:

- for 1 cable up to 5 x 10 mm²



Ref. no. **574339**

Components:

- 2 Domestic sockets 16A, 230V ~ (type F - German standard)
- 1 CEE socket 16A, 400V, 5p
- 1 CEE socket 32A, 400V, 5p

Protection:

- 2 C-type MCBs 16A, 1p
- 1 C-type MCB 16A, 3p
- 1 C-type MCB 32A, 3p
- 1 RCCB 40/0.03A, 4p

Cable entry:

- 1x M40

Connection option:

- for 1 cable up to 5 x 10 mm²

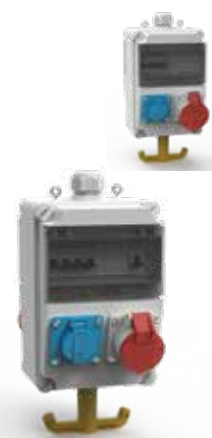

Ref. no. **573671**

Components:

- 6 Domestic sockets 16A, 230V ~ (type F - German standard)

Protection:

- 6 C-type MCBs 16A, 1p
- 1 RCCB 40/0.03A, 4p

Cable entry:

- 1 x M32

Connection option:

- for 1 cable up to 5 x 16 mm²



Ref. no. **572551**

Components:

- 4 Domestic sockets 16A, 230V ~ (type F - German standard)

Protection:

- 4 C-type MCBs 16A, 1p
- 1 RCCB 40/0.03A, 4p

Cable entry:

- 1x M32

Connection option:

- for 1 cable up to 5 x 25 mm²



Ref. no. **572185**

Components:

- 3 Domestic sockets 16A, 230V ~ (type F - German standard)
- 1 CEE socket 16A, 400V, 5p

Protection:

- 3 C-type MCBs 16A, 1p
- 1 C-type MCB 16A, 3p
- 1 RCCB 40/0.03A, 4p

Cable entry:

- 1x M32

Connection option:

- for 1 cable up to 5 x 10 mm²



Ref. no. **574420**

Components:

- 2 Domestic sockets 16A, 230V ~ (type F - German standard)
- 2 CEE sockets 16A, 400V, 5p
- 1 compressed air connection:
Input: 1/2" pipe with external thread
Output: 1/2" quick-release connector

Protection:

- 2 C-type MCBs 16A, 1p
- 2 C-type MCBs 16A, 3p

Cable entry:

- 1x M32

Connection option:

- for 1 cable up to 5 x 10 mm²



Combinations

Cross distributors

Technical information

- Wired ready for connection
- Protection degree IP44
- All distributors comply with the DIN EN 61439 / IEC 61439

- Enclosure made of high-grade, impact-resistant plastic
- Small, compact design
- Variable configuration
- Hanging bracket made of V2A stainless steel

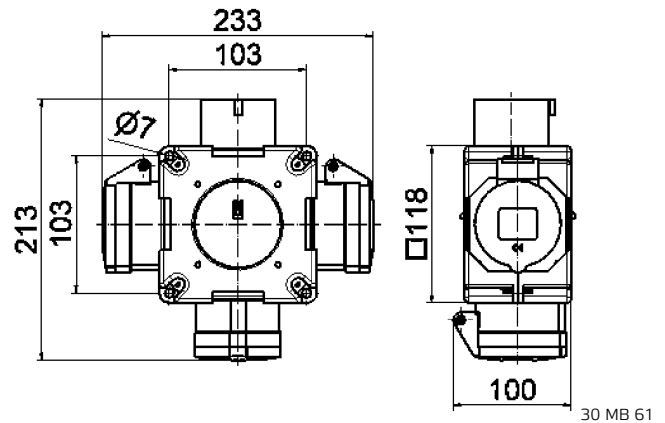

Ref. no. **54655**

Components:

- 2 Domestic sockets 16A, 230V ~ (type F - German standard)
- 1 CEE socket 16A, 230V, 3p

Cable entry/Input:

- 1 CEE inlet 16A, 230V, 3p



Ref. no. **54657**

Components:

- 2 Domestic sockets 16A, 230V ~ (type F - German standard)
- 1 CEE socket 16A, 400V, 5p

Cable entry/Input:

- 1 CEE plug 16A, 400V, 5p with 1.5 m cable H07RN-F5G2,5



Ref. no. **54880**

Components:

- 3 Domestic sockets 16A, 230V ~ (type F - German standard)
- 1 CEE socket 16A, 400V, 5p

Cable entry/Input:

- 1x M25

Connection option:

- for 1 cable up to 5x 2.5 mm²



Ref. no. **54568**

Components:

- 3 CEE sockets 16A, 230V, 3p

Cable entry/Input:

- 1 CEE plug 16A, 230V, 3p with 1.5 m cable H07RN-F3G2,5



Ref. no. **54566**

Components:

- 3 CEE sockets 16A, 230V, 3p

Cable entry/Input:

- 1 CEE inlet 16A, 230V, 3p



Ref. no. **54569**

Components:

- 3 CEE sockets 16A, 400V, 5p

Cable entry/Input:

- 1 CEE plug 16A, 400V, 5p with 1.5 m cable H07RN-F5G2,5



Technical information

- Wired ready for connection
- Protection degree IP44
- All distributors comply with the DIN EN 61439 / IEC 61439

Ref. no. **546**

Components:
3 CEE sockets 16A, 400V, 5p

Cable entry/Input:
1 CEE inlet 16A, 400V, 5p



Ref. no. **54567**

Components:
3 CEE sockets 32A, 400V, 5p

Cable entry/Input:
1 CEE inlet 32A, 400V, 5p



Ref. no. **54740**

Components:
2 Domestic sockets 16A, 230V ~
(type F - German standard)
1 CEE socket 16A, 400V, 5p

Cable entry/Input:
1x M25

Connection option:
for 1 cable up to 5x 2.5 mm²



Ref. no. **54929**

Components:
4 Domestic sockets 16A, 230V ~
(type F - German standard)

Cable entry/Input:
1x M25

Connection option:
for 1 cable up to 5x 2.5 mm²



Ref. no. **540055**

Components:
1 Domestic socket 16A, 230V ~
(type F - German standard)
2 CEE sockets 16A, 400V, 5p

Cable entry/Input:
1x M25

Connection option:
for 1 cable up to 5x 2.5 mm²



Ref. no. **54741**

Components:
3 Domestic sockets 16A, 230V, 3p

Cable entry/Input:
1x M25

Connection option:
for 1 cable up to 5x 2.5 mm²



Ref. no. **54580**

Components:
2 Domestic sockets 16A, 230V ~
(type F - German standard)
1 CEE socket 16A, 400V, 5p

Cable entry/Input:
1 CEE inlet 16A, 400V, 5p

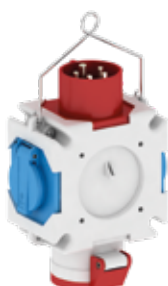

Ref. no. **54801**

Components:
3 Domestic sockets 16A, 230V ~
(type F - German standard)

Cable entry/Input:
1x M25

Connection option:
for 1 cable up to 5x 2.5 mm²



1

2

3

4

5

6

7

8

Combinations

Solid-Rubber distributor, hanging

Technical information

- Wired ready for connection
- Protection degree IP44
- All distributors comply with the DIN EN 61439 / IEC 61439

- Enclosure made of high-quality, impact-resistant solid rubber
- Small, compact design
- Variable configuration
- Fuse protection and data systems safely protected behind an operating window
- Top and bottom in signal yellow
- Hanging bracket made of V2A stainless steel
- Easy connection and disconnection of loads by means of knob or handle bracket
- Unproblematic connection of supply cable by means of specially developed clamping ring

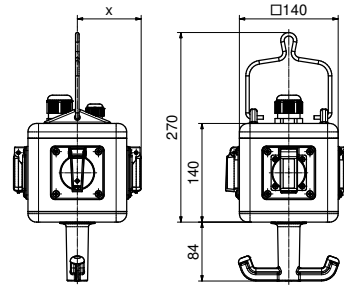

13 MB 124

Depth X (in mm)

Component	IP44	IP67	Component	IP44	IP67
Operating window	90		CEE 16A 5p	127	130
Domestic socket	98,5	114	CEE 32A 3p / 4p	130	135
CEE 16A 3p	121	127	CEE 32A 5p	139	139
CEE 16A 4p	123	128			

Ref. no. 57092

Components:

4 Domestic sockets 16A, 230V ~
(type F - German standard)

Cable entry:

1x M25

Connection option:

for 1 cable up to 5 x 10 mm²



Ref. no. 57076

Components:

3 Domestic sockets 16A, 230V ~
(type F - German standard)
1 CEE socket 16A, 400V, 5p

Cable entry:

1x M25

Connection option:

for 1 cable up to 5 x 10 mm²



Ref. no. 57078

Components:

2 Domestic sockets 16A, 230V ~
(type F - German standard)
2 CEE sockets 16A, 400V, 5p

Cable entry:

1x M25

Connection option:

for 1 cable up to 5 x 10 mm²



Ref. no. 57117

Components:

2 Domestic sockets 16A, 230V ~
(type F - German standard)
2 CEE sockets 16A, 400V, 5p
1 compressed air connection:
Input: 1/2" pipe with external thread
Output: 1/2" quick-release connector

Cable entry:

1x M25

Connection option:

for 1 cable up to 5 x 10 mm²



Ref. no. 57116

Components:

3 Domestic sockets 16A, 230V ~
(type F - German standard)
1 CEE socket 16A, 400V, 5p
1 compressed air connection:
Input: 1/2" pipe with external thread
Output: 1/2" quick-release connector

Cable entry:

1x M25

Connection option:

for 1 cable up to 5 x 10 mm²



Ref. no. 57119

Components:

4 Domestic sockets 16A, 230V ~
(type F - German standard)
1 compressed air connection:
Input: 1/2" pipe with external thread
Output: 1/2" quick-release connector

Cable entry:

1x M25

Connection option:

for 1 cable up to 5 x 10 mm²



Technical information

- Wired ready for connection
- Protection degree IP44
- All distributors comply with the DIN EN 61439 / IEC 61439

Ref. no. **571121**

Components:

- 3 Domestic sockets 16A, 230V ~ (type F - German standard)
- 1 CEE socket 16A, 400V, 5p
- 1 compressed air connection
- Input: 1/2" hose connector NW 13 mm
- Output: 1/2" two-way quick-release connector

Cable entry:

2x M25 (2 circuits)

Connection option:

for 2 cables up to 5 x 10 mm²



Ref. no. **573395**

Components:

- 3 Domestic sockets 16A, 230V ~ (type F - German standard)
- 4 data sockets RJ45/ Cat. 6

Cable entry:

1x M25, 1x M32

Connection option:

for 1 cable up to 5 x 10 mm²



Ref. no. **57829**

Components:

- 2 Domestic sockets 16A, 230V ~ (type F - German standard)
- 1 CEE socket 16A, 400V, 5p

Protection:

1 RCCB 40/0.03A, 4p

Cable entry:

1x M25

Connection option:

for 1 cable up to 5 x 10 mm²



Ref. no. **57250**

Components:

- 2 Domestic sockets 16A, 230V ~ (type F - German standard)
- 1 CEE socket 16A, 400V, 5p
- 1 CEE socket 32A, 400V, 5p

Cable entry:

1x M25, 1x M32

Connection option:

for 2 cables up to 5 x 10 mm²



Ref. no. **576277**

Components:

- 3 Domestic sockets 16A, 230V ~ (type F - German standard)
- 1 Overvoltage protection 230 LA

Cable entry:

1x M20

Connection option:

for 1 cable up to 5 x 10 mm²



Ref. no. **57074**

Components:

- 4 CEE sockets 16A, 400V, 5p

Cable entry:

1x M25

Connection option:

for 1 cable up to 5 x 10 mm²



Ref. no. **571276**

Components:

- 3 Domestic sockets 16A, 230V ~ (type F - German standard)

Protection:

1 RCCB 40/0.03A, 4p

Cable entry:

1x M25

Connection option:

for 1 cable up to 5 x 10 mm²



Ref. no. **570531**

Components:

- 2 Domestic sockets 16A, 230V ~ (type F - German standard)
- 1 CEE socket 16A, 400V, 5p
- 1 empty space for data sockets

Cable entry:

2x M25

Connection option:

for 1 cable up to 5 x 10 mm²



1

2

3

4

5

6

7

8

Combinations

Solid-Rubber distributor, hanging

Technical information

- Wired ready for connection
- Protection degree IP44
- All distributors comply with the DIN EN 61439 / IEC 61439

Ref. no. **573143**

Components:

3 Domestic sockets 16A, 230V ~
(type F - German standard)
2 RJ45 CAT6a below operating window,
can be closed with the plugs plugged in

Cable entry:

2x M25

Connection option:

for 1 cable up to 5 x 10 mm²



Ref. no. **572301**

Components:

3 Domestic sockets 16A, 230V ~
(type F - German standard)
2 Potential equalisation plug

Cable entry:

1 x M16, 1 x M25

Connection option:

for 1 cable up to 5 x 10 mm²



Ref. no. **572238**

Components:

3 Domestic sockets 16A, 230V ~
(type F - German standard)
1 Emergency off

Cable entry:

1 x M20, 1 x M25

Connection option:

for 1 cable up to 5 x 10 mm²



Ref. no. **570451**

Components:

4 Domestic sockets 16A, 230V ~
(type F - German standard)

Protection:

1 RCCB 40/0.03A, 4p

Cable entry:

1x M20

Connection option:

for 1 cable up to 5 x 10 mm²



Ref. no. **576282**

Components:

4 Domestic sockets 16A, 230V ~
(type F - German standard)
2 RJ45 CAT6a below operating window,
can be closed with the plugs plugged in

Cable entry:

2 x M20
1 x M25 with multiple sealing insert

Connection option:

for 1 cable up to 5 x 10 mm²



Ref. no. **573151**

Components:

6 Domestic sockets 16A, 230V ~
(type F - German standard)
2 RJ45 CAT6a below operating window,
can be closed with the plugs plugged in

Cable entry:

2x M25

Connection option:

for 1 cable up to 5 x 10 mm²



Ref. no. **57360**

Components:

3 Domestic sockets 16A, 230V ~
(type F - German standard)
1 empty space for data sockets

Cable entry:

2x M25

Connection option:

for 1 cable up to 5 x 10 mm²



Ref. no. **571370**

Components:

2 Domestic sockets 16A, 230V ~
(type F - German standard)
with child protection
2 Laboratory sockets yellow/green, earth
potential

2 Laboratory sockets 2x blue and 2x red
DC extra-low voltage

2 Laboratory sockets yellow, AC
extra-low voltage

Cable entry:

4x M20

Connection option:

for 1 cable up to 3 x 10 mm²



- Dimension of the bollard: 1355 x 250 mm
- Made of robust, hot-dip galvanised steel enclosure
- Ideal for safe energy distribution outdoors
- Vandal-proof owing to internally hinged door
- Lockable door with cylinder lock
- Cable outlet in door allows locking in connected state
- Safe protection of fuse elements behind operating window
- Suitable for base mounting
- RAL 7016; other colours possible on request
- Concrete base: see page 260

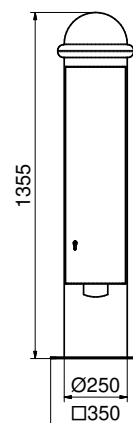

45 MB 19

Ref. no. **561090**

Components:

2 Domestic sockets 16A, 230V ~
(Type F - German standard)
1 CEE socket 16A, 400V, 5p
1 CEE socket 32A, 400V, 5p

Protection:

2 C-type MCBs 16A, 1p
1 C-type MCB 16A, 3p
1 C-type MCB 32A, 3p
1 RCCB 40/0.03A, 4p

Connection option:

for 2 cables up to 5 x 25 mm²



Ref. no. **562372**

Components:

2 Domestic sockets 16A, 230V ~
(Type F - German standard)
2 CEE sockets 16A, 400V, 5p

Protection:

2 C-type MCBs 16A, 1p
2 C-type MCBs 16A, 3p
1 RCCB 40/0.03A, 4p

Connection option:

for 2 cables up to 5 x 25 mm²



- Dimension of the bollard: 1120 x 273 mm
- Protection degree IP44
- Made of robust, hot-dip galvanised steel enclosure
- Ideal for safe energy distribution outdoors
- Vandal-proof owing to internally hinged door
- Lockable door with cylinder lock
- Cable outlet in door allows locking in connected state
- Suitable for base mounting
- RAL 7016; other colours possible on request
- Concrete base: see page 260

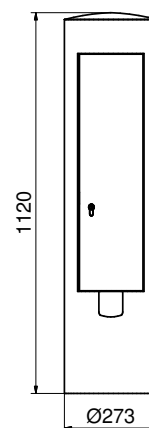

45 MB 74

Ref. no. **562389**

Components:

2 Domestic sockets 16A, 230V ~
(Type F - German standard)
1 CEE socket 16A, 400V, 5p

Protection:

2 C-type MCBs 16A, 1p
1 C-type MCB 16A, 3p
1 RCCB 40/0.03A, 4p

Cable entry:

2x M40

Connection option:

for 2 cables up to 5 x 25 mm²



Ref. no. **562390**

Components:

3 Domestic sockets 16A, 230V ~
(Type F - German standard)

Protection:

3 C-type MCBs 16A, 1p
1 RCCB 40/0.03A, 4p

Cable entry:

2x M40

Connection option:

for 1 cable up to 5 x 10 mm²



- Dimension of the bollard: 1120 x 324 mm
- Protection degree IP44
- Made of robust, hot-dip galvanised steel enclosure
- Ideal for safe energy distribution outdoors
- Vandal-proof owing to internally hinged door
- Lockable door with cylinder lock
- Cable outlet in door allows locking in connected state
- Suitable for base mounting
- RAL 7016; other colours possible on request
- Concrete base: see page 260

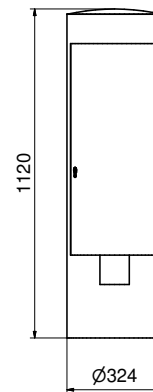

45 MB 73

Ref. no. **562391**

Components:

- 2 Domestic sockets 16A, 230V ~ (Type F - German standard)
- 1 CEE socket 16A, 400V, 5p
- 1 CEE socket 32A, 400V, 5p

Protection:

- 2 C-type MCBs 16A, 1p
- 1 C-type MCB 16A, 3p
- 1 C-type MCB 32A, 3p
- 1 RCCB 40/0.03A, 4p

Cable entry:

2x M40

Connection option:

for 2 cables up to 5 x 25 mm²



Ref. no. **562392**

Components:

- 2 Domestic sockets 16A, 230V ~ (Type F - German standard)
- 2 CEE sockets 16A, 400V, 5p

Protection:

- 2 C-type MCBs 16A, 1p
- 2 C-type MCBs 16A, 3p
- 1 RCCB 40/0.03A, 4p

Cable entry:

2x M40

Connection option:

for 2 cables up to 5 x 25 mm²



- Dimension of the bollard: 1420 x 420 mm
- Protection degree IP44
- Made of robust, hot-dip galvanised steel enclosure
- Ideal for safe energy distribution outdoors
- Vandal-proof owing to internally hinged door
- Lockable door with cylinder lock
- Cable outlet in door allows locking in connected state
- Suitable for base mounting
- RAL 7016; other colours possible on request
- Concrete base: see page 260

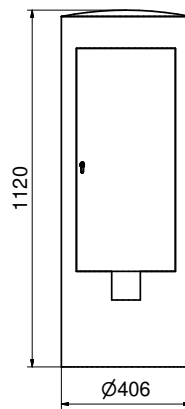

45 MB 75

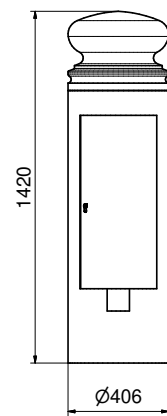

45 MB 39

Ref. no. **562366**

Components:

- 4 Domestic sockets 16A, 230V ~ (Type F - German standard)
- 1 CEE socket 16A, 400V, 5p
- 1 CEE socket 32A, 400V, 5p
- 1 CEE socket 63A, 400V, 5p

Protection:

- 4 C-type MCBs 16A, 1p
- 1 C-type MCB 16A, 3p
- 1 C-type MCB 32A, 3p
- 1 C-type MCB 63A, 3p
- 1 RCCB 63/0.03A, 4p

Cable entry:

2x M50

Connection option:

for 2 cables up to 5 x 25 mm²



Ref. no. **562393**

Components:

- 4 Domestic sockets 16A, 230V ~ (Type F - German standard)
- 2 CEE sockets 16A, 400V, 5p
- 1 CEE socket 32A, 400V, 5p

Protection:

- 4 C-type MCBs 16A, 1p
- 2 C-type MCBs 16A, 3p
- 1 C-type MCB 32A, 3p
- 1 RCCB 63/0.03A, 4p

Cable entry:

2x M40

Connection option:

for 2 cable up to 5 x 25 mm²



- Enclosure made of high-quality V2A stainless steel
- Brushed surface
- Door with box lock and single profile cylinder
- Wall mounting brackets, supplied loose
- Brush seal prevents dirt and dust from entering when door is closed
- Lockable in connected state
- Outgoing cables can be guided out through brush-sealed opening on front side
- Easy access to operating elements

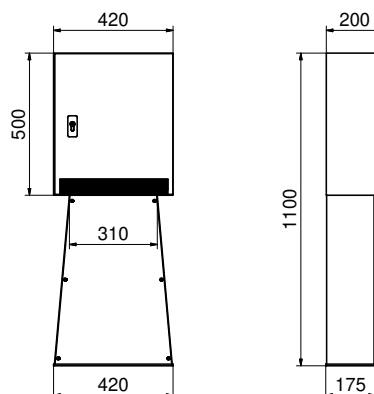

45 MB 18

Ref. no. **560030**

Components:

- 2 Domestic sockets 16A, 230V ~ (Type F - German standard)
- 1 CEE socket 16A, 400V, 5p
- 1 CEE socket 32A, 400V, 5p

Protection:

- 2 B-type MCBs 16A, 1p
- 1 C-type MCB 16A, 3p
- 1 C-type MCB 32A, 3p
- 1 RCCB 63/0,03A, 4p

Cable entry:

- 1 x M25, 1 x M32, 1 x M40

Connection option:

für 2 cables up to 5 x 25 mm²



Power-Port floor-standing distributor without door

- Housing made of high-quality V2A stainless steel
- Ground metal surface
- For VARIABOX and MODBOX-Midi
- Moveable panel for concealing cables
- Base plate suitable for pedestal mounting
- Available in different colours (optional)

Ref. no. **580589**

Mounting set for VARIABOX mounting
Order no. 581267

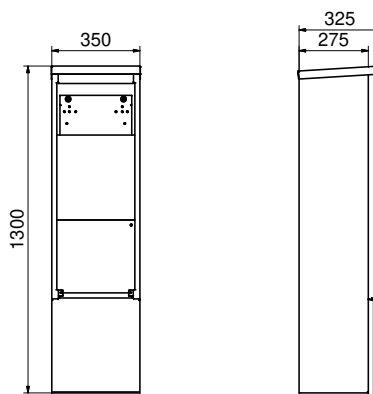

45 MB 59



Power-Port floor-standing distributor with door

- Housing made of high-quality V2A stainless steel
- Ground metal surface
- For VARIABOX and MODBOX-Midi
- Moveable panel for concealing cables
- Base plate suitable for pedestal mounting
- Door with box lock and single profile cylinder, internal hinges
- Brush seal prevents dirt and dust from entering when door is closed
- Outgoing cables can be guided out through brush-sealed opening on front side
- Available in different colours (optional)

Ref. no. **580508**

Mounting set for VARIABOX mounting
Order no. 581267

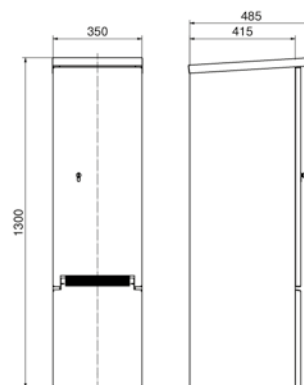

45 MB 55



Pillar with protective rain canopy

- Housing made of high-quality V2A stainless steel
- Ground metal surface
- For VARIABOX S, M und L
- Base plate suitable for pedestal mounting
- Available in different colours (optional)

Ref. no. **580860**

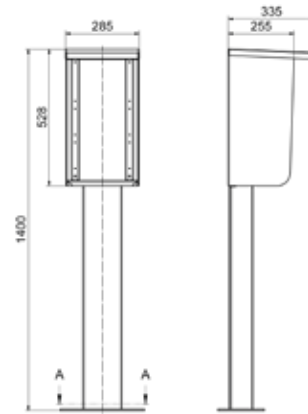

45 MB 64



Protective rain canopy

- Housing made of high-quality V2A stainless steel
- With side panels
- Ground metal surface
- Mounting plate for fitting VARIABOXES
- Available in RAL colours (optional)

Ref. no. **580511**

- for VARIABOX S,M,L
- Dimensions: 545 x 286 x 328 mm

Ref. no. **580529**

- for VARIABOX XL,XXL
- Dimensions: 792 x 286 x 328 mm

Ref. no. **580521**

- for VARIABOX L-DUO, XL-DUO
- Dimensions: 662 x 516 x 328 mm



Weather protection for EVOBOX distributor

- available for all EVOBOX sizes
- individually adapted to the distributor
- Black side walls, transparent front and back walls

On request



Concrete Base

- for ground/floor attachment for Power-Ports

Ref. no. **58370**



Ground Anchor

- for ground/floor attachment for Distribution bollards

Ref. no. **581323**

- for Distribution bollards $\varnothing 273\text{mm}$

Ref. no. **581324**

- for Distribution bollards $\varnothing 324\text{mm}$

Ref. no. **581325**

- for Distribution bollards $\varnothing 420\text{mm}$



Cable gland

- Black
- Protection degreee IP67



Thread	Sealing range	Ref. no.
M12	3-6 mm	580647
M20	8-13 mm	580648
M25	11-17 mm	580649
M32	15-21 mm	580650
M40	19-28 mm	580651
Multiple sealing insert	für M25	2x8 mm 580652
	für M32	4x8 mm 580653
Sealing plug for multiple sealing insert		581273
Packaging unit 100 pieces		

Cable gland with pressure equalisation

The use of pressure equalisation cable glands allows the internal pressure to adjust to the ambient pressure. The type-tested protection degree of the enclosure is fully retained. Temperature fluctuations, intense sunlight, or a sudden change in weather can cause condensation to form in combination enclosures. Basically, condensation can form in all sealed solid-rubber distributors. The higher the protection degree is, the more likely the formation of condensation will be.

We therefore recommend, especially in the case of distributors with protection degree IP67, the use of pressure equalisation cable glands.

- Minimised condensation formation and therefore reduction in downtimes and time-consuming and expensive repair work
- No expensive and high-maintenance ventilation technology required
- No drip holes which reduce the level of protection
- With air ducts for pressure equalisation
- Black
- Protection degree IP67



Thread	Sealing range	Ref. no.
M20	6-13 mm	580656
M25	9-17 mm	580657
M32	13-21 mm	580658
M40	16-28 mm	580659

Mounting set

- For VARIABOX S - XL, MODBOX and MODBOX-Midi
- Consisting of:
 - 4 screws 6 x 60 mm
 - 4 screw anchors 8 x 51 mm

Ref. no. **580640**



- For VARIABOX XXL
- Consisting of:
 - 6 screws 6 x 60 mm
 - 6 screw anchors 8 x 51 mm

Ref. no. **580727**

Lock set

- For OTC window
- With long shackle and 2 keys

Ref. no. **580642**



Closing cylinder

- For operation window
- With closing cylinder and 2 keys

Ref. no. **58037-BE**



Portable stand

- Hot-dip galvanised steel tubing
- Folding
- Weight 4 kg
- Dimensions: 350/570 x 780 x 540 mm (W x H x D)

Ref. no. **580643**
- For VARIABOX M, L, XL

Ref. no. **580721**
- For MODBOX and MODBOX-Midi



Hanging unit

- For VARIABOX M and L
- Colour yellow, RAL 1023

Ref. no. **580641**



Positioners

The positioner is an effective helper in the area of workplace ergonomics: it finally enables the simple, height-variable positioning of supply units. The smooth-running height adjustment facilitates an ergonomic provision of the power supply. The braking force can be simply adjusted using the adjustment screw located on the side. With this product, you can position the Bals power distributors even more easily and more flexibly in their application area. Simply lifting or pulling down is enough to individually adjust the height.

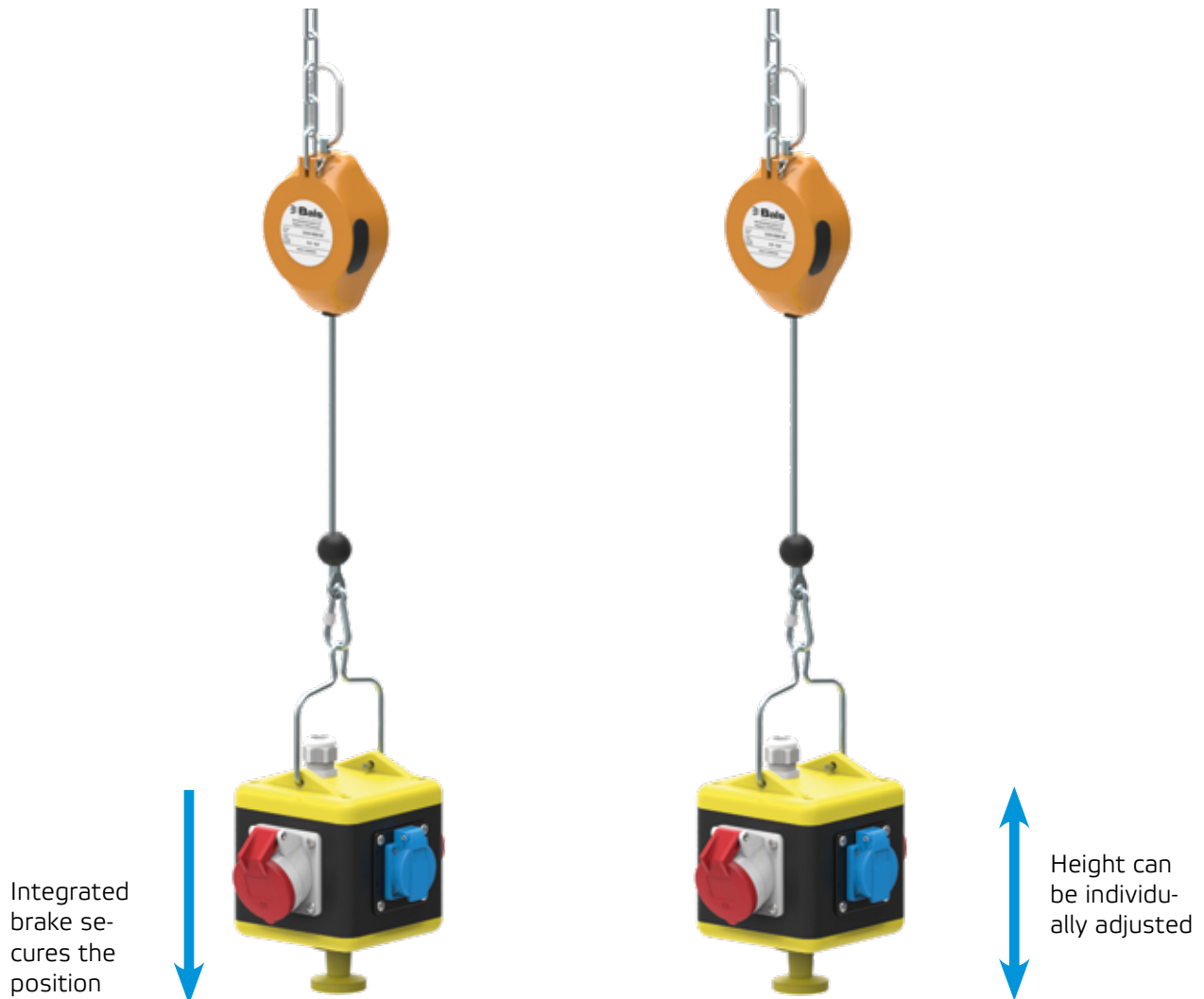

With the positioner, the risk of injury posed by hanging supply units is greatly minimised. Depending on the use, the height of the suspended unit can be conveniently varied. The integrated brake ensures that the position is securely held in place – even if the weight is changed, e.g., by plugging in or unplugging compressed air hoses. The housing, manufactured from a special plastic, is extremely impact resistant and is, thus, also suitable for use in very harsh production environments.



- 1 Safety suspension
- 2 Fall protection
- 3 Nameplate
- 4 Elastic cable stop buffer
- 5 Cover (adjustment screw for brake)
- 6 Load hook



Version:

Housing made of extremely impact-resistant special plastic Load attached via secure screw-type spring hook Braking force adjustable via adjustment screw located on the side

Safety device:

- Fall protection equipped as standard
- Riveted special spring for retracting the suspension rope
- Isolated suspension
- Very dimensionally stable construction

Technical parameters:

- Net weight: 0.8 kg
- Cable travel: 1.5 meters

Ref. No. **581219**

- Braking force: 0.5 - 6.0 kg

Ref. No. **581433**

- Braking force: 2.0 - 7.0 kg

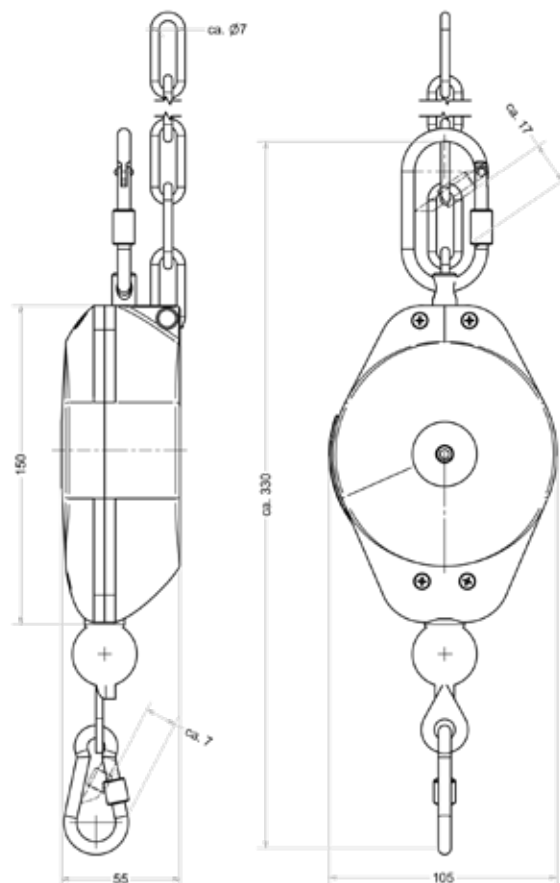





1

2

3

4

5

6

7

8

Plugs and Sockets 7-pole



Plugs and Sockets Special 1h Grounding Position

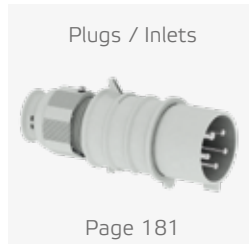

Plugs and Sockets Extra-Low Voltage



Plugs and Sockets DC



Plugs and Sockets 5h Grounding Position



High-Current Plugs and Sockets Above 125A

Surface Mounting Socket
Outlets



Page 191

Plugs / Inlets



Page 191

1

2

3

4

5

6

7

8

Special Plugs and Sockets

Plugs and sockets 7-pole

Technical information

- For plugs and sockets: polarity switchover circuits / star-delta circuit

Surface Mounting Socket Outlet TE

- Screw terminals
- High-temperature-resistant contact carrier
- Nickel plated contacts
- Cable entry 1x at top (open), 2x at bottom (closed)
- Base rotatable by 180°
- 4 mounting holes in enclosure base
- Protection degree IP44



11481

Ampere	6p+E Poles	230V 50-60 Hz	400V 50-60 Hz	Qty	g
		7pol 9h	7pol 6h		
16	7	11480	11481	10	375
32	7	11482	11483	10	455

Panel Mounting Socket Outlet TE

- Screw terminals
- High-temperature-resistant contact carrier
- Nickel plated contacts
- Flange 75 x 75 mm
- Protection degree IP44



13329

Ampere	6p+E Poles	230V 50-60 Hz	400V 50-60 Hz	Qty	g
		7pol 9h	7pol 6h		
16	7	13326	13327	10	195
32	7	13328	13329	10	270

Panel Mounting Socket Outlet TE

- Screw terminals
- 20° angled
- High-temperature-resistant contact carrier
- Nickel plated contacts
- Flange 100 x 92 mm
- Protection degree IP44



12393

Ampere	6p+E Poles	230V 50-60 Hz	400V 50-60 Hz	Qty	g
		7pol 9h	7pol 6h		
16	7	12390	12391	10	215
32	7	12392	12393	10	290

Plug TE with MULTI-GRIP

- Screw terminals
- High-temperature-resistant contact carrier
- Nickel plated contacts
- Special gland, simultaneous cable gland and seal
- Protection degree IP44



210067

Ampere	6p+E Poles	230V 50-60 Hz	400V 50-60 Hz	Qty	g
		7pol 9h	7pol 6h		
16	7	210550	21557	10	220
32	7	210636	210067	10	345

MULTI-GRIP

Surface Mounting Appliance Inlet TE

- Screw terminals
- High-temperature-resistant contact carrier
- Nickel plated contacts
- Protection degree IP44



24196

Ampere	6p+E Poles	230V 50-60 Hz	400V 50-60 Hz	Qty	g
		7pol 9h	7pol 6h		
16	7	24193	24194	10	340
32	7	24195	24196	10	420

Technical information

- For plugs and sockets: polarity switchover circuits / star-delta circuit

Connector TE with MULTI-GRIP

- Screw terminals
- High-temperature-resistant contact carrier
- Nickel plated contacts
- Special gland, simultaneous cable gland and seal
- Protection degree IP44



MULTI-GRIP

310123

Ampere	6p+E Poles	230V 50-60 Hz	400V 50-60 Hz	Qty	each
		7pol 9h	7pol 6h		
16	7	310311	31752	10	250
32	7	310381	310123	10	395

Surface Mounting Socket Outlet TE

- Screw terminals
- High-temperature-resistant contact carrier
- Nickel plated contacts
- Protection degree IP67



11542

Ampere	6p+E Poles	230V 50-60 Hz	400V 50-60 Hz	Qty	each
		7pol 9h	7pol 6h		
16	7	11634	11542	1	495

Surface Mounting Socket Outlet TE

- Screw terminals
- High-temperature-resistant contact carrier
- Nickel plated contacts
- Protection degree IP67



11714

Ampere	6p+E Poles	230V 50-60 Hz	400V 50-60 Hz	Qty	each
		7pol 9h	7pol 6h		
32	7	11635	11714	1	875

Panel Mounting Socket Outlet TE

- Screw terminals
- High-temperature-resistant contact carrier
- Nickel plated contacts
- Flange 75 x 75 mm
- Protection degree IP67



13333

Ampere	6p+E Poles	230V 50-60 Hz	400V 50-60 Hz	Qty	each
		7pol 9h	7pol 6h		
16	7	13330	13331	10	230
32	7	13332	13333	10	320

Panel Mounting Socket Outlet TE

- Screw terminals
- 20° angled
- High-temperature-resistant contact carrier
- Nickel plated contacts
- Flange 100 x 92 mm
- Protection degree IP67



12397

Ampere	6p+E Poles	230V 50-60 Hz	400V 50-60 Hz	Qty	each
		7pol 9h	7pol 6h		
16	7	12394	12395	10	245
32	7	12396	12397	10	335

1
2
3
4
5
6
7
8

Special Plugs and Sockets

Plugs and sockets 7-pole

Technical information

- For plugs and sockets: polarity switchover circuits / star-delta circuit

Plug TE with MULTI-GRIP

- Screw terminals
- High-temperature-resistant contact carrier
- Nickel plated contacts
- Special gland, simultaneous cable gland and seal
- Protection degree IP67



MULTI-GRIP

21669

Ampere	6p+E Poles	230V 50-60 Hz	400V 50-60 Hz	Qty	g
		7pol 9h	7pol 6h		
16	7	21711	21667	10	255
32	7	21712	21669	10	405

Connector TE with MULTI-GRIP

- Screw terminals
- High-temperature-resistant contact carrier
- Nickel plated contacts
- Special gland, simultaneous cable gland and seal
- Protection degree IP67



MULTI-GRIP

31515

Ampere	6p+E Poles	230V 50-60 Hz	400V 50-60 Hz	Qty	g
		7pol 9h	7pol 6h		
16	7	31512	31513	10	295
32	7	31514	31515	10	465

Surface Mounting Socket Outlet TE

- High-temperature-resistant contact carrier
- Nickel plated contacts
- Switched
- Lockable in 0-position
- Protection degree IP44



16374

Ampere	6p+E Poles	230V 50-60 Hz	400V 50-60 Hz	Qty	g
		7pol 9h	7pol 6h		
16	7	16441	16374	1	1105

Surface Mounting Socket Outlet TE

- High-temperature-resistant contact carrier
- Nickel plated contacts
- Switched
- With mechanical double interlocking
- Lockable in 0-position
- Protection degree IP44



16378

Ampere	6p+E Poles	230V 50-60 Hz	400V 50-60 Hz	Qty	g
		7pol 9h	7pol 6h		
16	7	16445	16378	1	220
32	7		160438	1	345

Surface Mounting Socket Outlet TE

- High-temperature-resistant contact carrier
- Nickel plated contacts
- Switched
- With mechanical double interlocking
- Lockable in 0-position
- Protection degree IP67



16380

Ampere	6p+E Poles	230V 50-60 Hz	400V 50-60 Hz	Qty	g
		7pol 9h	7pol 6h		
16	7	16447	16380	1	1120
32	7		160087	1	1975

Technical information

- For plugs and sockets: polarity switchover circuits / star-delta circuit

Panel Mounting Appliance Inlet TE

- Screw terminals
- High-temperature-resistant contact carrier
- Nickel plated contacts
- Protection degree IP44



26002

Ampere	6p+E Poles	230V	400V	Qty	each
		50-60 Hz	50-60 Hz		
16	7	26012	26013	10	200
32	7	26001	26002	10	300

Panel Mounting Appliance Inlet TE

- Screw terminals
- High-temperature-resistant contact carrier
- Nickel plated contacts
- Protection degree IP67



26006

Ampere	6p+E Poles	230V	400V	Qty	each
		50-60 Hz	50-60 Hz		
16	7	26003	26004	10	275
32	7	26005	26006	10	350

Panel Mounting Appliance Inlet TE

- Screw terminals
- High-temperature-resistant contact carrier
- Nickel plated contacts
- Protection degree IP67



27120

Ampere	6p+E Poles	230V	400V	Qty	each
		50-60 Hz	50-60 Hz		
16	7	27117	27118	10	240
32	7	27119	27120	10	410

Special Plugs and Sockets

Plugs and sockets 1h grounding position

Technical information

- IEC 60309, EN 60309, VDE 0623

Surface Mounting Socket Outlet QUICK-CONNECT TE

- Screwless terminals
- Kontex contact
- Nickel plated contacts
- Cable entry 1x at top (open) and 1x at bottom (closed) for 16A 3p
- Cable entry 1x at top (open), 2x at bottom (closed) for 16A 4p - 32A 5p
- Base rotatable by 180°
- Protection degree IP44



110579

QUICK-CONNECT

		>50 - 500V				
2P+E Ampere	3P+E Poles	3pol 1h	4pol 1h	5pol 1h	Qty	Each
16	3	110577	10	185		
16	4	110353	10	305		
16	5	110394	10	330		
32	4	110578	10	370		
32	5	110579	10	380		

Surface Mounting Socket Outlet TE

- Cable entry 1x at top (open), 2x at bottom (closed) for 63A
- Cable entry M50 from above for 125A
- Base rotatable by 180° for 63A
- High-temperature-resistant contact carrier
- Kontex contact
- Box terminals
- Nickel plated contacts
- Protection degree IP44 for 63A, IP67 for 125A



11889



110140

		>50 - 500V				
2P+E Ampere	3P+E Poles	3pol 1h	4pol 1h	5pol 1h	Qty	Each
63	5	11889	5	825		
125	5	110140	1	2085		

Panel Mounting Socket Outlet QUICK-CONNECT TE

- Screwless terminals
- High-temperature-resistant contact carrier
- Kontex contact
- Nickel plated contacts
- Flange 75 x 75 mm
- Protection degree IP44



130278

QUICK-CONNECT

		>50 - 500V				
2P+E Ampere	3P+E Poles	3pol 1h	4pol 1h	5pol 1h	Qty	Each
16	3	130277	10	110		
16	4	130077	10	130		
16	5	130278	10	170		
32	4	130040	10	205		
32	5	13822	10	225		

Panel Mounting Socket Outlet TE

- Screw terminals
- Flange 107 x 100 for 63A
- Flange 120 x 120 for 125A
- High-temperature-resistant contact carrier
- Kontex contact
- Box terminals
- Nickel plated contacts
- Protection degree IP44 for 63A, IP67 for 125A



130279



13613

		>50 - 500V				
2P+E Ampere	3P+E Poles	3pol 1h	4pol 1h	5pol 1h	Qty	Each
63	5	130279	5	530		
125	5	13613	5	1125		

Panel Mounting Socket Outlet QUICK-CONNECT TE

- Screwless terminals
- 20° angled
- High-temperature-resistant contact carrier
- Kontex contact
- Nickel plated contacts
- Flange 85 x 85 mm
- Protection degree IP44



120256

QUICK-CONNECT

		>50 - 500V				
2P+E Ampere	3P+E Poles	3pol 1h	4pol 1h	5pol 1h	Qty	Each
16	3	120442	10	125		
16	4	120150	10	145		
16	5	120282	10	175		
32	4	120157	10	235		
32	5	120256	10	265		

Technical information

- IEC 60309, EN 60309, VDE 0623

Panel Mounting Socket Outlet TE

- Screw terminals
- 15° angled
- Flange 114 x 114 mm
- High-temperature-resistant contact carrier
- Kontex contact
- Box terminals
- Nickel plated contacts
- Protection degree IP44 for 63A, IP67 for 125A



120280

12689

2P+E Ampere		3P+E Poles		>50 - 500V			Qty		g	
3pol	4pol	5pol	1h	1h	1h	Each	Each	Each	Each	
63	5	120280			5	665				
125	5	12689			5	980				

Plug TE-Plus with MULTI-GRIP

- Screwless terminals
- High-temperature-resistant contact carrier
- Nickel plated contacts
- Special gland, simultaneous cable gland and seal
- Protection degree IP44



21907

2P+E Ampere		3P+E Poles		>50 - 500V			Qty		g	
3pol	4pol	5pol	1h	1h	1h	Each	Each	Each	Each	
16	3	210402			10	125				
16	4	210668			10	145				
16	5	21907			10	180				
32	4	210358			10	260				
32	5	210238			10	295				

QUICK-CONNECT
MULTI-GRIP

Plug TE with MULTI-GRIP

- Screw terminal
- Box terminals
- High-temperature-resistant contact carrier
- Nickel plated contacts
- Special gland, simultaneous cable gland and seal
- Protection degree IP44 for 63A, IP67 for 125A



21785

21966

2P+E Ampere		3P+E Poles		>50 - 500V			Qty		g	
3pol	4pol	5pol	1h	1h	1h	Each	Each	Each	Each	
63	5	21785			5	655				
125	5	21966			5	1235				

MULTI-GRIP

Surface Mounting Appliance Inlet QUICK-CONNECT TE

- Screwless terminals
- High-temperature-resistant contact carrier
- Nickel plated contacts
- Cable entry 1x at top (open), 2x at bottom (closed)
- Base rotatable by 180°
- 4 mounting holes in enclosure base
- Suitable for through wiring
- Protection degree IP44



24625

2P+E Ampere		3P+E Poles		>50 - 500V			Qty		g	
3pol	4pol	5pol	1h	1h	1h	Each	Each	Each	Each	
16	5	24625			10	305				
32	4	24626			10	380				
32	5	24627			10	385				

QUICK-CONNECT

Surface Mounting Appliance Inlet TE

- Screw terminals
- Box terminals
- Cable entry 1x at top (open) and 2x at bottom (closed) for 63A
- Cable entry M50 from above for 125A
- Base rotatable by 180° for 63A
- High-temperature-resistant contact carrier
- Nickel plated contacts
- Protection degree IP44 for 63A, IP67 for 125A



24594

24241

2P+E Ampere		3P+E Poles		>50 - 500V			Qty		g	
3pol	4pol	5pol	1h	1h	1h	Each	Each	Each	Each	
63	5	24594			5	1020				
125	5	24241			1	1235				

1

2

3

4

5

6

7

8

Special Plugs and Sockets

Plugs and sockets 1h grounding position

Technical information

- IEC 60309, EN 60309, VDE 0623

Connector TE-Plus with MULTI-GRIP

- Screwless terminals
- High-temperature-resistant contact carrier
- Kontex contact
- Nickel plated contacts
- Special gland, simultaneous cable gland and seal
- Protection degree IP44



310044

QUICK CONNECT
MULTI-GRIP

2P+E Ampere		3P+E Poles		>50 - 500V			Qty	g
				3pol 1h	4pol 1h	5pol 1h	Each	
16	3			310564	10		145	
16	4			310519	10		170	
16	5			310068	10		200	
32	4			31779	10		310	
32	5			310044	10		340	

Connector TE with Multi-Grip

- Screw terminal
- Box terminals
- High-temperature-resistant contact carrier
- Kontex contact
- Nickel plated contacts
- Protection degree IP44 for 63A, IP67 for 125A



31627

MULTI-GRIP

2P+E Ampere		3P+E Poles		>50 - 500V			Qty	g
				3pol 1h	4pol 1h	5pol 1h	Each	
63	5			31627	5		670	
125	5			31641	5		1300	

31641

Surface Mounting Socket Outlet

- Screw terminals
- Cable entry 1x at top (open)
- Protection degree IP44

Ampere	Poles	24V 50-60 Hz	42V 50-60 Hz	100-200Hz up to 50V	300Hz up to 50V	400Hz up to 50V	up to 50V	Qty	Each
		12h	4h	2h	3h	10h			

16	2	410	411	412	413	414	415	10	180
16	3	416	417	418	419	4110	4107	10	195
32	2	4111	4112	4113	4114	4115	4116	10	180
32	3	4117	4118	4119	4120	4121	4157	10	195



4118

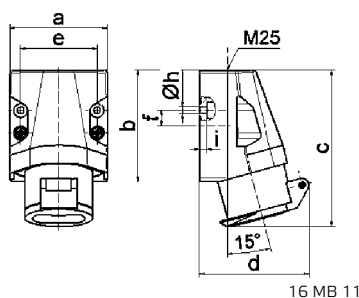

Ampere	16	16	32	32
Poles	2	3	2	3
a	70,0	70,0	70,0	70,0
b	80,0	80,0	80,0	80,0
c	113,0	113,0	113,0	113,0
d	80,0	80,0	80,0	80,0
e	55,0	55,0	55,0	55,0
f	11,0	11,0	11,0	11,0
ø h	5,2	5,2	5,2	5,2
i	5,0	5,0	5,0	5,0
Cond. mm² min	4	4	4	4
Cond. mm² max	10	10	10	10

16 MB 11

Panel Mounting Socket Outlet

- Screw terminals
- Straight
- Flange 55 x 55 mm
- Protection degree IP44

Ampere	Poles	24V 50-60 Hz	42V 50-60 Hz	100-200Hz up to 50V	300Hz up to 50V	400Hz up to 50V	up to 50V	Qty	Each
		12h	4h	2h	3h	10h			

16	2	430	431	432	433	434	435	10	110
16	3	436	437	438	439	4310	4390	10	125
32	2	4311	4312	4313	4314	4315	4316	10	110
32	3	4317	4318	4319	4320	4321		10	125



4318

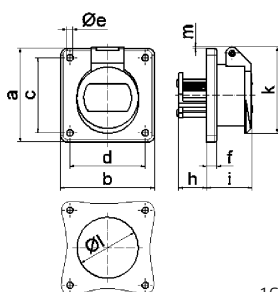

Ampere	16	16	32	32
Poles	2	3	2	3
a	55,0	55,0	55,0	55,0
b	55,0	55,0	55,0	55,0
c	45,0	45,0	45,0	45,0
d	45,0	45,0	45,0	45,0
ø e	5,2	5,2	5,2	5,2
f	6,0	6,0	6,0	6,0
h	22,0	22,0	22,0	22,0
i	37,0	37,0	37,0	37,0
k	67,0	67,0	67,0	67,0
ø l	49,0	49,0	49,0	49,0
m	12,0	12,0	12,0	12,0
Cond. mm² min	4	4	4	4
Cond. mm² max	10	10	10	10

16 MB 13

Panel Mounting Socket Outlet

- Screw terminals
- Straight
- Flange 75 x 75 mm
- Protection degree IP44

Ampere	Poles	24V 50-60 Hz	42V 50-60 Hz	100-200Hz up to 50V	300Hz up to 50V	400Hz up to 50V	up to 50V	Qty	Each
		12h	4h	2h	3h	10h			

16	2	4354	4355	4356	4357	4358	4359	10	130
16	3	4360	4361	4362	4363	4364	43003	10	150
32	2	4365	4366	4367	4368	4369	4370	10	130
32	3	4371	4372	4373	4374	4375		10	150



4372

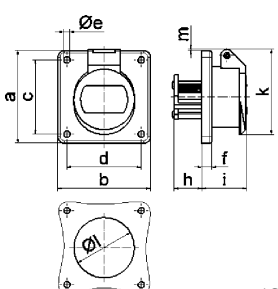

Ampere	16	16	32	32
Poles	2	3	2	3
a	75,0	75,0	75,0	75,0
b	75,0	75,0	75,0	75,0
c	60,0	60,0	60,0	60,0
d	60,0	60,0	60,0	60,0
ø e	5,2	5,2	5,2	5,2
f	6,0	6,0	6,0	6,0
h	22,0	22,0	22,0	22,0
i	37,0	37,0	37,0	37,0
k	67,0	67,0	67,0	67,0
ø l	49,0	49,0	49,0	49,0
m	2,0	2,0	2,0	2,0
Cond. mm² min	4	4	4	4
Cond. mm² max	10	10	10	10

16 MB 47

Special Plugs and Sockets

Plugs and sockets extra-low voltages

Technical information

- IEC 60309, VDE 0623

Panel Mounting Socket Outlet

- Screw terminals
- 20° angled
- Flange 68 x 62 mm
- Protection degree IP44



4218

Ampere	Poles	24V 50-60 Hz	42V 50-60 Hz	100-200Hz up to 50V	300Hz up to 50V	400Hz up to 50V	up to 50V	Qty	Each
		12h	4h	2h	3h	10h			
16	2	420	421	422	423	424	425	10	115
16	3	426	427	428	429	4210		10	135
32	2	4211	4212	4213	4214	4215	4216	10	115
32	3	4217	4218	4219	4220	4221	4274	10	135

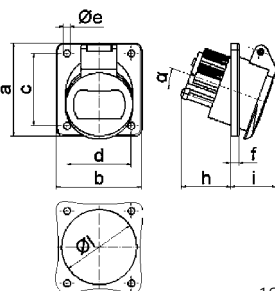

16 MB 12

Ampere Poles	16 2	16 3	32 2	32 3
a	68,0	68,0	68,0	68,0
b	62,0	62,0	62,0	62,0
c	53,0	53,0	53,0	53,0
d	47,0	47,0	47,0	47,0
ø e	5,2	5,2	5,2	5,2
f	6,0	6,0	6,0	6,0
h	36,0	36,0	36,0	36,0
i	35,0	35,0	35,0	35,0
α	20°	20°	20°	20°
ø l	55,0	55,0	55,0	55,0
Cond. mm² min	4	4	4	4
Cond. mm² max	10	10	10	10

Panel Mounting Socket Outlet

- Screw terminals
- 20° angled
- Flange 100 x 92 mm
- Protection degree IP44



4240

Ampere	Poles	24V 50-60 Hz	42V 50-60 Hz	100-200Hz up to 50V	300Hz up to 50V	400Hz up to 50V	up to 50V	Qty	Each
		12h	4h	2h	3h	10h			
16	2	4222	4223	4224	4225	4226	4227	10	150
16	3	4228	4229	4230	4231	4232		10	165
32	2	4233	4234	4235	4236	4237	4238	10	150
32	3	4239	4240	4241	4242	4243		10	165

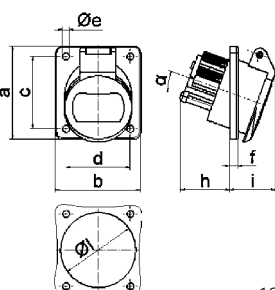

16 MB 48

Ampere Poles	16 2	16 3	32 2	32 3
a	100,0	100,0	100,0	100,0
b	92,0	92,0	92,0	92,0
c	85,0	85,0	85,0	85,0
d	77,0	77,0	77,0	77,0
ø e	5,2	5,2	5,2	5,2
f	6,0	6,0	6,0	6,0
h	36,0	36,0	36,0	36,0
i	35,0	35,0	35,0	35,0
α	20°	20°	20°	20°
ø l	55,0	55,0	55,0	55,0
Cond. mm² min	4	4	4	4
Cond. mm² max	10	10	10	10

Surface Mounting Socket Outlet

- Screw terminals
- Protection degree IP44



4619

Ampere	Poles	24V 50-60 Hz	42V 50-60 Hz	100-200Hz up to 50V	300Hz up to 50V	400Hz up to 50V	up to 50V	Qty	Each
		12h	4h	2h	3h	10h			
16	2	460	461	462	463	464	465	10	140
16	3	466	467	468	469	4610		10	165
32	2	4611	4612	4613	4614	4615	4616	10	140
32	3	4617	4618	4619	4620	4621		10	165

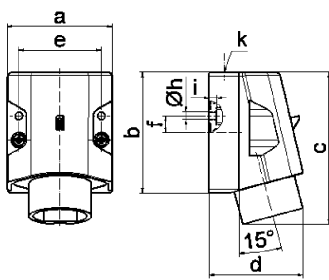

16 MB 15

Ampere Poles	16 2	16 3	32 2	32 3
a	70,0	70,0	70,0	70,0
b	80,0	80,0	80,0	80,0
c	100,0	100,0	100,0	100,0
d	82,0	82,0	82,0	82,0
e	55,0	55,0	55,0	55,0
f	11,0	11,0	11,0	11,0
ø h	5,2	5,2	5,2	5,2
i	5,0	5,0	5,0	5,0
k	M25	M25	M25	M25
Cond. mm² min	4	4	4	4
Cond. mm² max	10	10	10	10

Technical information

- IEC 60309, VDE 0623

Plug with MULTI-GRIP

- Screw terminals
- Nickel plated contacts
- Special gland, simultaneous cable gland and seal
- Protection degree IP44

MULTI-GRIP



4441

Ampere	Poles	24V 50-60 Hz	42V 50-60 Hz	100-200Hz up to 50V	300Hz up to 50V	400Hz up to 50V	up to 50V	Qty	Each
		12h	4h	2h	3h	10h			
16	2	4422	4423	4424	4425	4426	4427	10	125
16	3	4428	4429	4430	4431	4432	4481	10	160
32	2	4433	4434	4435	4436	4437	4438	10	125
32	3	4439	4440	4441	4442	4443		10	160

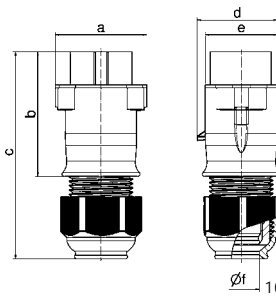

Ampere	16	16	32	32
Poles	2	3	2	3
a	62,0	62,0	62,0	62,0
b	85,0	85,0	85,0	85,0
c	140,0	140,0	140,0	140,0
d	55,0	55,0	55,0	55,0
e	50,0	50,0	50,0	50,0
ø f	24,5	24,5	24,5	24,5
Cond. mm² min	4	4	4	4
Cond. mm² max	10	10	10	10

16 MB 43

Connector with MULTI-GRIP

- Screw terminals
- Nickel plated contacts
- Special gland, simultaneous cable gland and seal
- Protection degree IP44

MULTI-GRIP



4541

Ampere	Poles	24V 50-60 Hz	42V 50-60 Hz	100-200Hz up to 50V	300Hz up to 50V	400Hz up to 50V	up to 50V	Qty	Each
		12h	4h	2h	3h	10h			
16	2	4522	4523	4524	4525	4526	4527	10	185
16	3	4528	4529	4530	4531	4532	45044	10	205
32	2	4533	4534	4535	4536	4537	4538	10	185
32	3	4539	4540	4541	4542	4543		10	205

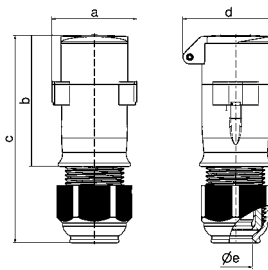

Ampere	16	16	32	32
Poles	2	3	2	3
a	62,0	62,0	62,0	62,0
b	96,0	96,0	96,0	96,0
c	152,0	152,0	152,0	152,0
d	67,0	67,0	67,0	67,0
ø e	24,5	24,5	24,5	24,5
Cond. mm² min	4	4	4	4
Cond. mm² max	10	10	10	10

16 MB 44

Reducer

- Suitable for cables less than Ø 8 mm
- For all 16A standard plugs and sockets with Multi-Grip as well as extra-low voltage



Ref. no.

29129

Special Plugs and Sockets

Plugs and sockets DC

Technical information

- IEC 60309, EN 60309, VDE 0623

Surface Mounting Socket Outlet

- Screw terminals
- Protection degree IP44

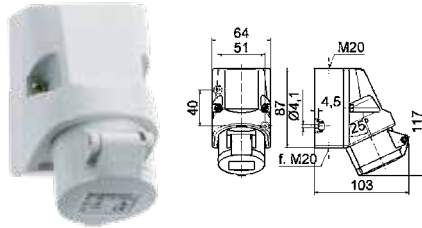

1 MB 35

Amperage	2p+E Poles	>50V up to 250V	>250V	Qty	g
		3pol 3h	3pol 8h		
16	3	11032		10	200

Panel Mounting Socket Outlet

- Screw terminals
- Straight
- Protection degree IP44

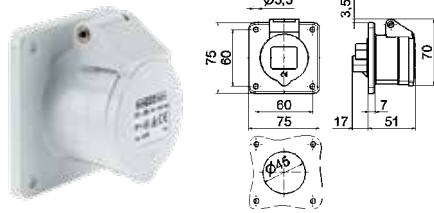

4 MB 74

Amperage	2p+E Poles	>50V up to 250V	>250V	Qty	g
		3pol 3h	3pol 8h		
16	3	13070		10	120

Panel Mounting Socket Outlet

- Screw terminals
- Angled
- Protection degree IP44

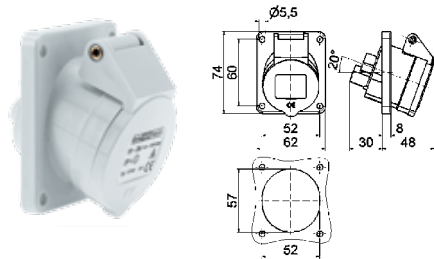

4 MB 73

Amperage	2p+E Poles	>50V up to 250V	>250V	Qty	g
		3pol 3h	3pol 8h		
16	3	12144		10	130

Plug TE-Plus with MULTI-GRIP

- Screwless terminals
- High-temperature-resistant contact carrier
- Nickel plated contacts
- Special gland, simultaneous cable gland and seal
- Protection degree IP44

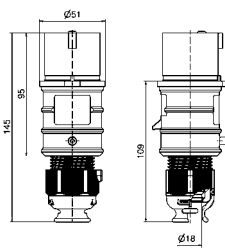

21868

2 MB 220

Amperage	2p+E Poles	>50V up to 250V	>250V	Qty	g
		3pol 3h	3pol 8h		
16	3	21868	21882	10	125

Plug TE-Plus with MULTI-GRIP

- Screwless terminals
- High-temperature-resistant contact carrier
- Nickel plated contacts
- Special gland, simultaneous cable gland and seal
- Protection degree IP44

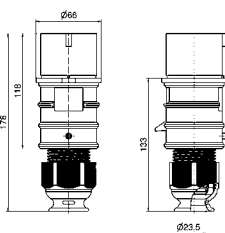

21869

2 MB 221

Amperage	2p+E Poles	>50V up to 250V	>250V	Qty	g
		3pol 3h	3pol 8h		
32	3	21869	21876	10	240

QUICK CONNECT
MULTI-GRIP

QUICK CONNECT
MULTI-GRIP

Technical information

- IEC 60309, EN 60309, VDE 0623

Plug TE with MULTI-GRIP

- Screw terminals
- Nickel plated contacts
- Screwless enclosure connection, self locking
- Special gland, simultaneous cable gland and seal
- Protection degree IP44

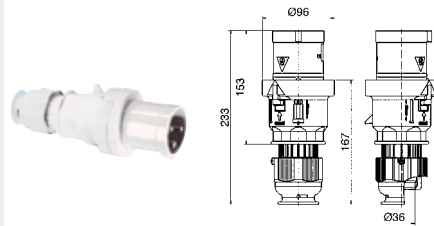

2 MB 226

MULTI-GRIP

Ampere	2p+E Poles	>50V up to 250V	>250V	Qty	Each
		3pol 3h	3pol 8h		
63	3	21706		5	535

Connector TE-Plus with MULTI-GRIP

- Screwless terminals
- High-temperature-resistant contact carrier
- Nickel plated contacts
- Special gland, simultaneous cable gland and seal
- Protection degree IP44

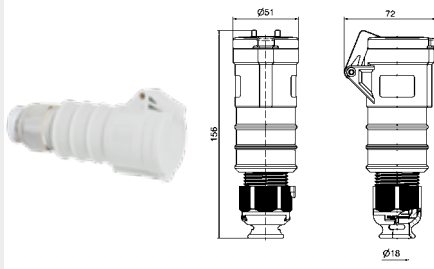

3 MB 123

QUICK-CONNECT MULTI-GRIP

Ampere	2p+E Poles	>50V up to 250V	>250V	Qty	Each
		3pol 3h	3pol 8h		
16	3	31677		10	145

Surface Mounting Socket Outlet

- Screw terminals
- Nickel plated contacts
- Switched
- With mechanical double interlocking
- Lockable in 0-position
- Protection degree IP44

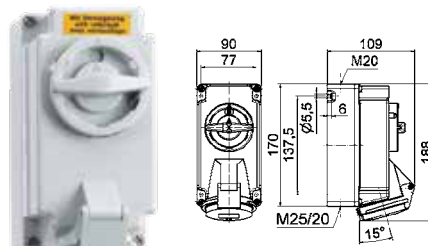

12 MB 29

Ampere	2p+E Poles	>50V up to 250V	>250V	Qty	Each
		3pol 3h	3pol 8h		
16	3	16449		1	575

Surface Mounting Socket Outlet

- Screw terminals
- Nickel plated contacts
- Switched
- With mechanical double interlocking
- Lockable in 0-position
- Protection degree IP44

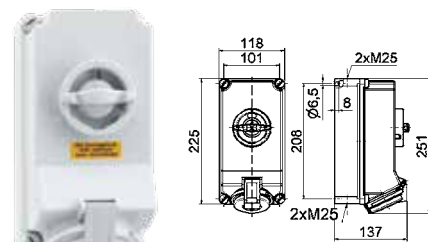

12 MB 28

Ampere	2p+E Poles	>50V up to 250V	>250V	Qty	Each
		3pol 3h	3pol 8h		
32	3	16450		1	1215

1

2

3

4

5

6

7

8

Special Plugs and Sockets

Plugs and sockets 5h grounding position

Technical information

- IEC 60309, EN 60309, VDE 0623

Surface Mounting Socket Outlet QUICK-CONNECT TE

- Screwless terminals
- Cable entry 1x at top (open), 2x at bottom (closed)
- Base rotatable by 180°
- High-temperature-resistant contact carrier
- Kontex contact
- Nickel plated contacts
- Protection degree IP44



110582

QUICK-CONNECT

Amperere	Poles	600-690V 50 + 60Hz		Qty	Each
		4pol 5h	5pol 5h		
16	4	110580	10	315	
16	5	110581	10	330	
32	4	110481	10	380	
32	5	110582	10	380	

Surface Mounting Socket Outlet TE

- Cable entry 1x at top (open), 2x at bottom (closed) for 63A
- Base rotatable by 180° for 63A
- Cable entry 1x M50 from above for 125A
- High-temperature-resistant contact carrier
- Kontex contact
- Box terminals
- Nickel plated contacts
- Protection degree IP44 for 63A, IP67 for 125A



110583



110328

QUICK-CONNECT

Amperere	Poles	600-690V 50 + 60Hz		Qty	Each
		4pol 5h	5pol 5h		
63	4	11334	5	795	
63	5	110583	5	830	
125	4	11019	1	1975	
125	5	110328	1	2085	

Panel Mounting Socket Outlet QUICK-CONNECT TE

- Screwless terminals
- High-temperature-resistant contact carrier
- Kontex contact
- Nickel plated contacts
- Flange 75 x 75 mm
- Protection degree IP44



130283

QUICK-CONNECT

Amperere	Poles	600-690V 50 + 60Hz		Qty	Each
		4pol 5h	5pol 5h		
16	4	130280	10	150	
16	5	130281	10	170	
32	4	130282	10	230	
32	5	130283	10	250	

Panel Mounting Socket Outlet TE

- Screw terminals
- Flange 107 x 100 for 63A
- Flange 120 x 120 for 125A
- High-temperature-resistant contact carrier
- Kontex contact
- Box terminals
- Nickel plated contacts
- Protection degree IP44 for 63A, IP67 for 125A



13849



130055

QUICK-CONNECT

Amperere	Poles	600-690V 50 + 60Hz		Qty	Each
		4pol 5h	5pol 5h		
63	4	13075	5	445	
63	5	13849	5	490	
125	4	130232	5	1005	
125	5	130055	5	1110	

Panel Mounting Socket Outlet QUICK-CONNECT TE

- Screwless terminals
- 20° angled
- High-temperature-resistant contact carrier
- Kontex contact
- Nickel plated contacts
- Flange 85 x 85 mm
- Protection degree IP44



120277

QUICK-CONNECT

Amperere	Poles	600-690V 50 + 60Hz		Qty	Each
		4pol 5h	5pol 5h		
16	4	120368	10	135	
16	5	120275	10	150	
32	4	120336	10	200	
32	5	120277	10	245	

Panel Mounting Socket Outlet TE

- Screw terminals
- 15° angled
- Flange 114 x 114 mm
- High-temperature-resistant contact carrier
- Kontex contact
- Box terminals
- Nickel plated contacts
- Protection degree IP44 for 63A, IP67 for 125A



12251

12065

		600-690V 50 + 60Hz			
3p+E	3+N+E	4pol 5h	5pol 5h	Qty	Each
63	4	12275		5	460
63	5	12251		5	500
125	4	12034		5	965
125	5	12065		5	980

Plug TE-Plus

- Screwless terminals
- High-temperature-resistant contact carrier
- Nickel plated contacts
- Special gland, simultaneous cable gland and seal
- Protection degree IP44



210779

		600-690V 50 + 60Hz			
3p+E	3+N+E	4pol 5h	5pol 5h	Qty	Each
16	4	210628		10	145
16	5	210778		10	180
32	4	210962		10	260
32	5	210779		10	310

QUICK-CONNECT
MULTI-GRIP

Plug TE

- Screw terminal
- Box terminals
- High-temperature-resistant contact carrier
- Nickel plated contacts
- Special gland, simultaneous cable gland and seal
- Screwless enclosure connection, self locking
- Protection degree IP44 for 63A, IP67 for 125A



21461

21059

		600-690V 50 + 60Hz			
3p+E	3+N+E	4pol 5h	5pol 5h	Qty	Each
63	4	21515		5	600
63	5	21461		5	655
125	4	21063		5	1125
125	5	21059		5	1245

MULTI-GRIP

Surface Mounting Appliance Inlet QUICK-CONNECT TE

- Screwless terminals
- Cable entry 1x at top (open), 2x at bottom (closed)
- Base rotatable by 180°
- 4 mounting holes in enclosure base
- Suitable for through wiring
- High-temperature-resistant contact carrier
- Nickel plated contacts
- Protection degree IP44



24630

		600-690V 50 + 60Hz			
3p+E	3+N+E	4pol 5h	5pol 5h	Qty	Each
16	5	24628		10	305
32	4	24629		10	380
32	5	24630		10	385

QUICK-CONNECT

Surface Mounting Appliance Inlet TE

- Screw terminals
- Box terminals
- Cable entry 1x at top (open) and 2x at bottom (closed) for 63A
- Cable entry M50 from above for 125A
- Base rotatable by 180° for 63A
- High-temperature-resistant contact carrier
- Nickel plated contacts
- Protection degree IP44 for 63A, IP67 for 125A



24632

24543

		600-690V 50 + 60Hz			
3p+E	3+N+E	4pol 5h	5pol 5h	Qty	Each
63	4	24631		5	925
63	5	24632		5	975
125	4	24250		1	2145
125	5	24543		1	2245

Special Plugs and Sockets

Plugs and sockets 5h grounding position

Technical information

- IEC 60309, EN 60309, VDE 0623

Connector TE-Plus

- Screwless terminals
- High-temperature-resistant contact carrier
- Kontex contact
- Nickel plated contacts
- Special gland, simultaneous cable gland and seal
- Protection degree IP44



310508

QUICK CONNECT
MULTI GRIP

Ampere	Poles	600-690V 50 + 60Hz		Qty	Each
		4pol 5h	5pol 5h		
16	4	310441	10	170	
16	5	310507	10	200	
32	4	310628	10	310	
32	5	310508	10	350	

Connector TE

- Screw terminal
- Box terminals
- High-temperature-resistant contact carrier
- Kontex contact
- Nickel plated contacts
- Special gland, simultaneous cable gland and seal
- Screwless enclosure connection, self locking
- Protection degree IP44 for 63A, IP67 for 125A



31716

31266

MULTI GRIP

Ampere	Poles	600-690V 50 + 60Hz		Qty	Each
		4pol 5h	5pol 5h		
63	4	31719	5	625	
63	5	31716	5	670	
125	4	31045	5	1215	
125	5	31266	5	1300	

Technical information

- Plugs and sockets above 125A and voltages up to 25kV

Surface Mounting Socket Outlet, Switched, Electrically Interlocked

- Stainless-steel enclosure AISI 304
- With integrated main switch and socket
- Protection degree IP55

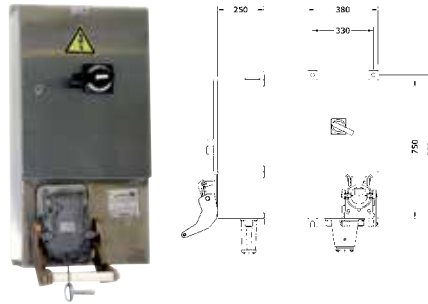

Ampere	Poles	Ref. no.	Cross section	Weight
250	4	160467		45,0 kg
400	4	160468		45,0 kg
250	5	160576		50,0 kg
400	5	160470		50,0 kg

Surface Mounting Socket Outlet, Switched, Electrically Interlocked

- Stainless-steel enclosure AISI 304
- With integrated main switch and socket
- Protection degree IP55

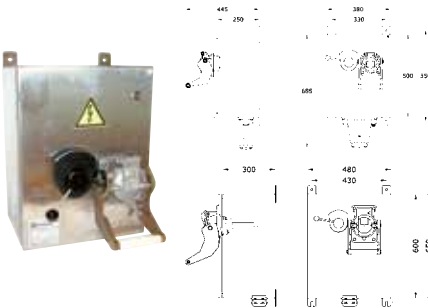

Ampere	Poles	Ref. no.	Cross section	Weight
250	4	160471		27,0 kg
400	4	160472		27,0 kg
250	5	160473		45,0 kg
400	5	160474		45,0 kg

Plug, Angled with Easy Locking System

- Metallic plugs and sockets
- External strain relief
- High-temperature-resistant contact carrier
- Silver-plated laminated contacts
- 2 internal pilot contacts for signaling and control purposes
- Plugs and sockets can be protected from dirt and dust by means of an additional protective cap
- IP66 when closed

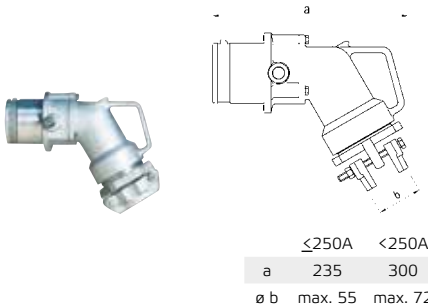

Ampere	Poles	Ref. no.	Cross section	Weight
160	4	2318	≤35	1,9 kg
200	4	2319	50	1,9 kg
250	4	2320	70	1,9 kg
320	4	2323	95	4,5 kg
420	4	2311	120/150	4,5 kg
160	5	2321	35	1,9 kg
200	5	2322	50	1,9 kg
250	5	2324	≤70	4,5 kg
320	5	2316	95	4,5 kg

Plug, Straight with Easy Locking System

- Metallic plugs and sockets
- External strain relief
- High-temperature-resistant contact carrier
- Silver-plated laminated contacts
- 2 internal pilot contacts for signaling and control purposes
- Plugs and sockets can be protected from dirt and dust by means of an additional protective cap
- IP66 when closed

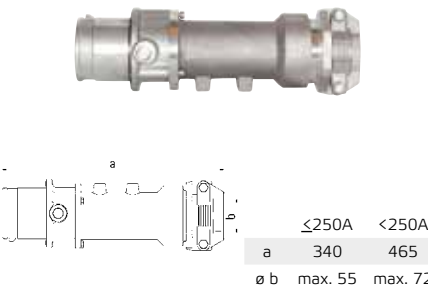

Ampere	Poles	Ref. no.	Cross section	Weight
160	4	211018	≤35	1,8 kg
200	4	211019	50	1,8 kg
250	4	211020	70	1,8 kg
320	4	211021	95	4,5 kg
420	4	211022	120/150	4,5 kg
160	5	211023	35	1,8 kg
200	5	211024	50	1,8 kg
250	5	211025	≤70	4,5 kg
320	5	211026	95	4,5 kg

Connector, Straight with Easy Locking System

- Metallic plugs and sockets
- External strain relief
- High-temperature-resistant contact carrier
- Silver-plated laminated contacts
- 2 internal pilot contacts for signaling and control purposes
- IP66 when closed

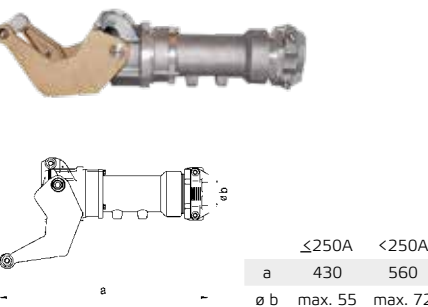

Ampere	Poles	Ref. no.	Cross section	Weight
160	4	310697	≤35	4,8 kg
200	4	310698	50	4,8 kg
250	4	310318	70	4,8 kg
320	4	310699	95	9,4 kg
420	4	310700	120/150	9,4 kg
160	5	310701	35	4,8 kg
200	5	310702	50	4,8 kg
250	5	310703	≤70	9,4 kg
320	5	310704	95	9,4 kg

1
2
3
4
5
6
7
8





1

2

3

4

5

6

7

8

Reefer Container

Surface Mounting Socket



Pages 197 - 198

Plugs / Inlets



Pages 197, 199

Panel Mounting Socket
Outlets



Page 197

Connectors



Page 198

VARIABOX



Page 199

Military Facilities

Panel Mounting Socket
Outlets



Pages 201 - 202

Plugs / Inlets



Pages 203 - 205

Connectors



Page 206

Domestic Plugs and
Sockets



Pages 207 - 208

Accessories



Pages 208 - 209

Event Technology

Panel Mounting Socket
Outlets



Page 211

Plugs



Pages 211 - 212

Inlets



Page 212

Connectors



Pages 212 - 213

Domestic Plugs and
Sockets



Pages 213 - 214

Camping

Surface Mounting Socket
Outlets



Page 216

Panel Mounting Socket
Outlets



Page 216

Caravan Flushmounting
Inlets



Page 216

Plugs / Inlets / Angled
Plugs



Pages 217 - 218

Connectors



Page 218

Adapter Plugs



Page 218

Domestic Plugs and
Sockets



Pages 218 - 219

Extension Leads



Page 219

1

2

3

4

5

6

7

8

Plugs and sockets for special fields of application

Reefer Container

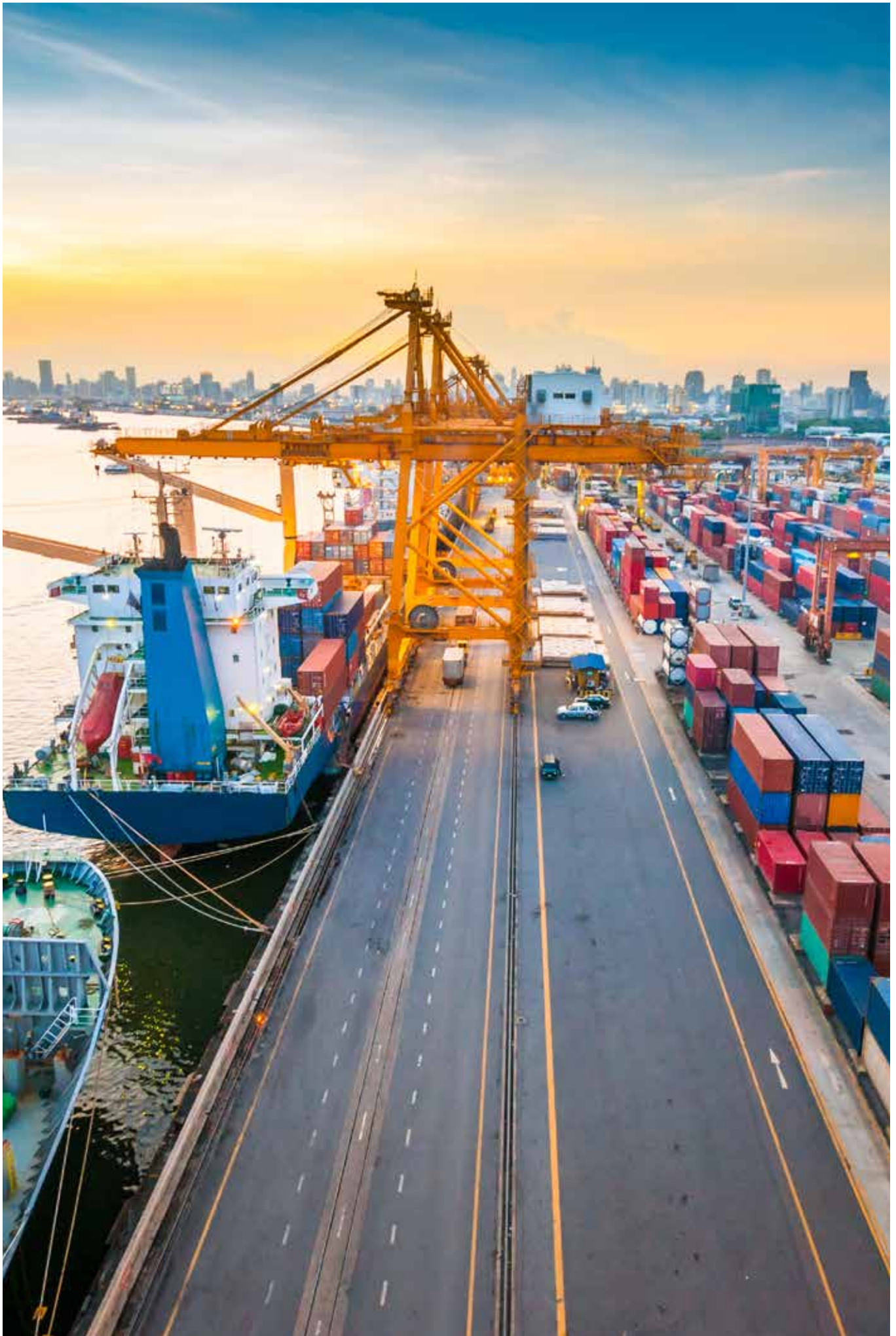

Technical information

- Container operating voltage 400 - 400V, clock face position 3h
- IEC 60309, EN60309, VDE 0623
- Protection degree IP67

Surface Mounting Socket Outlet TE

- CEE socket with screwless terminals
- Switched
- With mechanical double interlocking
- Lockable in 0-position
- High-temperature-resistant contact carrier
- Nickel plated contacts
- Protection degree IP67

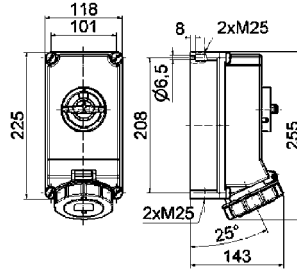

Ampere	3P+E Poles	380V (50Hz) and 440V (60Hz)	3h	Qty	9 each

QUICK CONNECT

16050

12 MB 27

Panel Mounting Socket Outlet TE

- Screw terminals
- High-temperature-resistant contact carrier
- Nickel plated contacts
- Straight
- Protection degree IP67

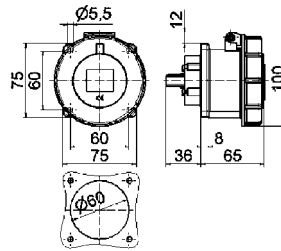

Ampere	3P+E Poles	380V (50Hz) and 440V (60Hz)	3h	Qty	9 each

13021

4 MB 71

Plug TE-Plus with MULTI-GRIP

- Screwless terminals
- High-temperature-resistant contact carrier
- Nickel plated contacts
- Special gland, simultaneous cable gland and seal
- Protection degree IP67

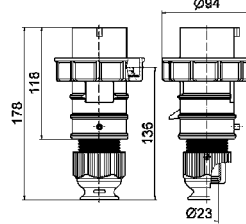

Ampere	3P+E Poles	380V (50Hz) and 440V (60Hz)	3h	Qty	9 each

210328

2 MB 111

Plug with MULTI-GRIP

- One-piece enclosure
- Nickel plated contacts
- Special gland, simultaneous cable gland and seal
- Protection degree IP67

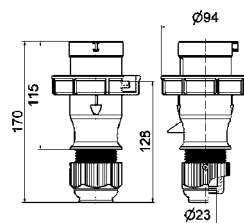

Ampere	3P+E Poles	380V (50Hz) and 440V (60Hz)	3h	Qty	9 each

Screw terminal

32	4	21232-TLQ		
----	---	------------------	--	--

MULTI-GRIP

210824

2 MB 128

Appliance Inlet with Flange TE

- Screw terminals
- With closure cap
- High-temperature-resistant contact carrier
- Nickel plated contacts
- Protection degree IP67

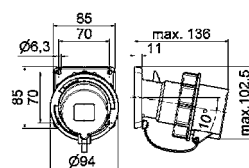

Ampere	3P+E Poles	380V (50Hz) and 440V (60Hz)	3h	Qty	9 each

27027

5 MB 23

1
2
3
4
5
6
7
8

Plugs and sockets for special fields of application

Reefer Container

Technical information

- Container operating voltage 400 - 400V, clock face position 3h
- IEC 60309, EN60309, VDE 0623
- Protection degree IP67

Closure Cap

- For CEE plugs
- Protection degree IP67



832

	Order no.
16A / 3p	830
16A / 4p	835
16A / 5, 7p	831
32A / 3p, 4p	837
32A / 5p, 7p	832
63A / 3p, 4p, 5p	833
125A / 3p, 4p, 5p	834

Connector TE-Plus with MULTI-GRIP

- Screwless terminals
- High-temperature-resistant contact carrier
- Nickel plated contacts
- Special gland, simultaneous cable gland and seal
- Protection degree IP67



310426

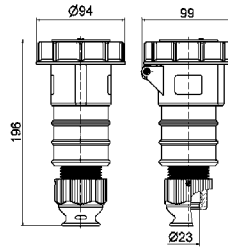

3 MB 72

Amperes	3P+E Poles	380V (50Hz) and 440V (60Hz) 3h	Qty	9 each
32	4	310426	10	390

QUICK-CONNECT
MULTI-GRIP

Connector with MULTI-GRIP

- One-piece enclosure
- Nickel plated contacts
- Special gland, simultaneous cable gland and seal
- Protection degree IP67



310567

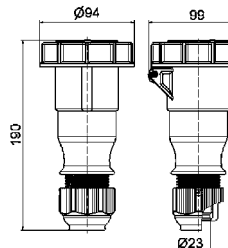

3 MB 80

Amperes	3P+E Poles	380V (50Hz) and 440V (60Hz) 3h	Qty	9 each
32	4	310567	10	334

Screw terminal

32	4	31186-TLQ	10	314
----	---	------------------	----	-----

MULTI-GRIP

Surface Mounting Socket Outlet QUICK-CONNECT TE

- Screwless terminals
- High-temperature-resistant contact carrier
- Nickel plated contacts
- Protection degree IP67



11556

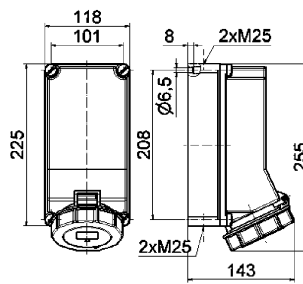

1 MB 30

Amperes	3P+E Poles	380V (50Hz) and 440V (60Hz) 3h	Qty	9 each
32	4	11556	1	805

QUICK-CONNECT

Surface Mounting Socket Outlet TE

- CEE socket with screwless terminals
- Switched
- With mechanical double interlocking
- Hinged window
- Lockable in 0-position
- High-temperature-resistant contact carrier
- Nickel plated contacts
- Protection degree IP67



17026

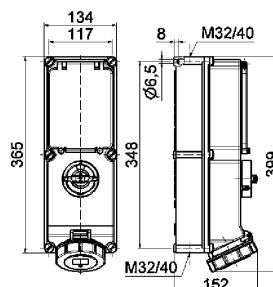

12 MB 26

Amperes	3P+E Poles	380V (50Hz) and 440V (60Hz) 3h	Qty	9 each
32	4	17026	1	1910

QUICK-CONNECT

Technical information

- Container operating voltage 400 - 400V, clock face position 3h
- IEC 60309, EN60309, VDE 0623
- Protection degree IP67

Test Plug

- Screw terminals
- For testing switch panel
- Nickel plated contacts
- Protection degree IP44



2298

Ampere	3P+E Poles	380V (50Hz) and 440V (60Hz)	3h	Qty	9 each
		32			

Variabox extension – switching bar:

- Perfect optical integration in the existing system
- User-friendly arrangement in the case of multiple units
- Mechanical double-interlocking
- Can be locked in the 0-position
- Nickel plated contacts
- High-temperature-resistant contact carriers
- Greater flexibility in the Variabox system landscape
- Suitable for harsh environmental conditions
- Versions in all voltages and frequencies from 16A 3-pole to 32A 5-pole
- Protection degrees IP44, IP54 and IP67

Ref. no. **896459**

VARIABOX-M

260 x 230 mm

Components:

1 CEE socket 32A, 400V, 4p, 3h, IP67
nickel plated contacts, with mechanical interlocking, lockable in 0-position

Fuse:

1 C-type MCB 32A, 3p
1 RCCB 40/0.03A, 4p

Cable entry at top and bottom:

each with 1x M12, 1x M20, 2x M40

Connection option:

2 cables up to 5 x 25 mm²



Ref. no. **896462**

VARIABOX-L

390 x 230 mm

Components:

2 CEE socket 32A, 400V, 4p, 3h, IP67
nickel plated contacts, with mechanical interlocking, lockable in 0-position

Fuse:

2 C-type MCB 32A, 3p
1 RCCB 63/0.03A, 4p

Cable entry at top and bottom:

each with 1x M12, 1x M20, 2x M40

Connection option:

2 cables up to 5 x 25 mm²



Ref. no. **896437**

VARIABOX-XL

520 x 230 mm

Components:

3 CEE socket 32A, 400V, 4p, 3h, IP67
nickel plated contacts, with mechanical interlocking, lockable in 0-position

Fuse:

3 C-type MCB 32A, 3p

Cable entry at top and bottom:

each with 1x M12, 1x M20, 2x M40

Connection option:

2 cables up to 5 x 25 mm²



Ref. no. **896463**

VARIABOX-L DUO

390 x 460 mm

Components:

4 CEE socket 32A, 400V, 4p, 3h, IP67
nickel plated contacts, with mechanical interlocking, lockable in 0-position

Fuse:

4 C-type MCB 32A, 3p
1 RCCB 63/0.03A, 4p

Cable entry at top and bottom:

each with 1x M12, 1x M20, 2x M40

Connection option:

2 cables up to 5 x 25 mm²





Technical information

- Colour: bronze-green RAL 6031-F9
 - IEC 60309, EN 60309, VDE 0623, VG 96919

Panel Mounting Socket Outlet QUICK-CONNECT

- Screwless terminals
- Straight
- Kontex contact
- High-temperature-resistant contact carrier
- Nickel plated contacts
- Flange 75 x 75 mm
- Protection degree IP67

(Form AS)

QUICK-CONNECT



13066



Ampere	Poles	Order no. Supply no. 5935-12-... VG-type-Nr. VG 96919-...	230V 50-60 Hz	400V 50-60 Hz	400V 60 Hz	301-500Hz >50V	g
			3pol 4pol 5pol 6h 9h 9h	3pol 4pol 5pol 9h 6h 6h	4pol 5pol 11h 11h	3pol 4pol 5pol 2h 2h 2h	
16	3	Order no. 13064 Supply no. 5935-12-... VG-type-Nr. VG 96919-...	320-7272 AS 013			13098	150
16	4	Order no. 13928 Supply no. 5935-12-... VG-type-Nr. VG 96919-...	AS 020	13633 AS 018	13929 AS 021	13930 AS 022	170
16	5	Order no. 13189* Supply no. 5935-12-... VG-type-Nr. VG 96919-...	AS 002	13065* 300-5324 AS 001	13182* AS 003	13183* AS 004	195
32	3	Order no. 13032 Supply no. 5935-12-... VG-type-Nr. VG 96919-...	AS 042			13932 AS 044	245
32	4	Order no. 13933 Supply no. 5935-12-... VG-type-Nr. VG 96919-...	AS 025	13634 AS 023	13166 AS 026	13935 AS 027	265
32	5	Order no. 13297* Supply no. 5935-12-... VG-type-Nr. VG 96919-...	AS 006	13066* 300-5323 AS 005	13184* AS 007	13175* 321-5242 AS 008	315

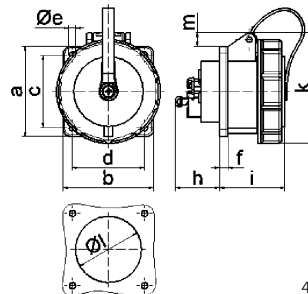

4 MB 125

Ampere Poles	16 3	16 4	16 5	32 3	32 4	32 5
a	75,0	75,0	75,0	75,0	75,0	75,0
b	75,0	75,0	75,0	75,0	75,0	75,0
c	60,0	60,0	60,0	60,0	60,0	60,0
d	60,0	60,0	60,0	60,0	60,0	60,0
Øe	5,5	5,5	5,5	5,5	5,5	5,5
f	7,0	7,0	7,0	8,0	8,0	8,0
h	35,0	35,0	35,0	50,0	50,0	50,0
i	57,0	57,0	57,0	69,0	69,0	69,0
k	77,0	83,0	93,0	98,0	98,0	107,0
Øl	45,0	75,0	55,0	60,0	60,0	60,0
m	4,0	7,0	12,0	12,0	12,0	17,0
Cond. mm² min	1,5	1,5	1,5	2,5	2,5	2,5
Cond. mm² max	4,0	4,0	4,0	10,0	10,0	10,0

Panel Mounting Socket Outlet

- Screw terminals
- Straight
- High-temperature-resistant contact carrier
- Box terminals
- Kontex contact
- Nickel plated contacts
- Flange 107 x 100 mm for 63A, 120 x 120 mm for 125A
- Protection degree IP67

(Form AS)



13067



Ampere	Poles	Order no. Supply no. 5935-12-... VG-type-Nr. VG 96919-...	230V 50-60 Hz	400V 50-60 Hz	400V 60 Hz	301-500Hz >50V	g
			3pol 4pol 5pol 6h 9h 9h	3pol 4pol 5pol 9h 6h 6h	4pol 5pol 11h 11h	3pol 4pol 5pol 2h 2h 2h	
63	3	Order no. 13186 Supply no. 5935-12-... VG-type-Nr. VG 96919-...	AS 047			13927	500
63	4	Order no. 13924 Supply no. 5935-12-... VG-type-Nr. VG 96919-...	AS 030	13839 AS 028	13925 AS 031	13926 AS 032	580
63	5	Order no. 13298* Supply no. 5935-12-... VG-type-Nr. VG 96919-...	AS 010	13067* 300-3603 AS 009	13187* AS 011	13188* 321-5243 AS 012	620
125	3	Order no. 13840 Supply no. 5935-12-... VG-type-Nr. VG 96919-...	AS 052			13923 AS 054	930
125	4	Order no. 13919 Supply no. 5935-12-... VG-type-Nr. VG 96919-...	AS 035	13841 AS 033	13920 AS 036	13921 AS 037	1090
125	5	Order no. 13915 Supply no. 5935-12-... VG-type-Nr. VG 96919-...	AS 015	13647 AS 014	13916 AS 016	13918 AS 017	1210

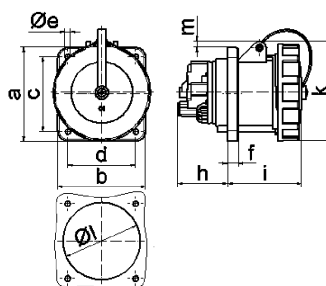

4 MB 134

Ampere Poles	63 3	63 4	63 5	125 3	125 4	125 5
a	107,0	107,0	107,0	120,0	120,0	120,0
b	100,0	100,0	100,0	120,0	120,0	120,0
c	85,0	85,0	85,0	100,0	100,0	100,0
d	77,0	77,0	77,0	100,0	100,0	100,0
Øe	6,5	6,5	6,5	6,5	6,5	6,5
f	12,0	12,0	12,0	21,0	21,0	21,0
h	57,0	57,0	57,0	50,0	50,0	50,0
i	77,0	77,0	77,0	117,0	117,0	117,0
k	113,0	113,0	113,0	129,0	129,0	129,0
Øl	88,0	88,0	88,0	104,0	104,0	104,0
m	8,0	8,0	8,0	6,0	6,0	6,0
Cond. mm² min	6,0	6,0	6,0	25,0	25,0	25,0
Cond. mm² max	25,0	25,0	25,0	70,0	70,0	70,0

Panel Mounting Socket Outlet QUICK-CONNECT

- Screwless terminals
- 20° angled
- Kontex contact
- High-temperature-resistant contact carrier
- Nickel plated contacts
- Flange 85 x 85 mm
- Protection degree IP67

(Form BS)

QUICK-CONNECT



12087



Ampere	Poles	Order no. Supply no. 5935-12-... VG-type-Nr. VG 96919...	230V 50-60 Hz		400V 50-60 Hz		400V 60 Hz		301-500Hz >50V			g
			3pol	4pol	5pol	3pol	4pol	5pol	4pol	5pol	3pol	
16	3		6h	9h	9h				2h	2h	2h	each
16	4											
16	5											
32	3											
32	4											
32	5											

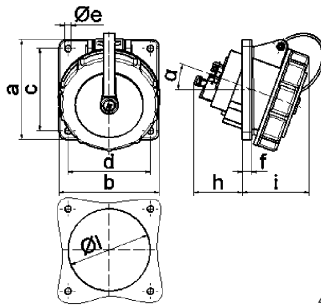

Ampere	16	16	16	32	32	32
Poles	3	4	5	3	4	5
a	85,0	85,0	85,0	85,0	85,0	85,0
b	85,0	85,0	85,0	85,0	85,0	85,0
c	70,0	70,0	70,0	70,0	70,0	70,0
d	70,0	70,0	70,0	70,0	70,0	70,0
Øe	5,5	5,5	5,5	5,5	5,5	5,5
f	8,0	8,0	8,0	8,0	8,0	8,0
h	46,0	46,0	46,0	50,0	50,0	50,0
i	57,0	57,0	60,0	67,0	67,0	67,0
Øl	57,0	65,0	70,0	78,0	78,0	78,0
α	20°	20°	20°	20°	20°	20°
Cond. mm² min	1,5	1,5	1,5	2,5	2,5	2,5
Cond. mm² max	4,0	4,0	4,0	10,0	10,0	10,0

4 MB 124

Panel Mounting Socket Outlet

- Screw terminals
- Angled
- High-temperature-resistant contact carrier
- Box terminals
- Kontex contact
- Nickel plated contacts
- Flange 114 x 114 mm
- Protection degree IP67

(Form BS)



12088



Ampere	Poles	Order no. Supply no. 5935-12-... VG-type-Nr. VG 96919...	230V 50-60 Hz		400V 50-60 Hz		400V 60 Hz		301-500Hz >50V			g
			3pol	4pol	5pol	3pol	4pol	5pol	4pol	5pol	3pol	
63	3		6h	9h	9h				2h	2h	2h	each
63	4											
63	5											
125	3											
125	4											
125	5											

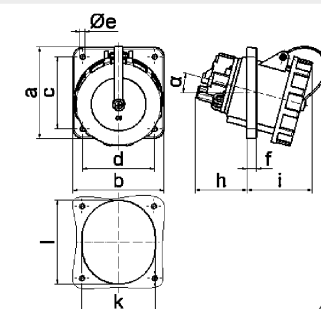

Ampere	63	63	63	125	125	125
Poles	3	4	5	3	4	5
a	114,0	114,0	114,0	114,0	114,0	114,0
b	114,0	114,0	114,0	114,0	114,0	114,0
c	90,0	90,0	90,0	90,0	90,0	90,0
d	90,0	90,0	90,0	90,0	90,0	90,0
Øe	5,5	5,5	5,5	6,5	6,5	6,5
f	12,0	12,0	12,0	12,0	12,0	12,0
h	65,0	65,0	65,0	82,0	82,0	82,0
i	82,0	82,0	82,0	90,0	90,0	90,0
k	92,0	92,0	92,0	92,0	92,0	92,0
Øl	92,0	92,0	92,0	105,0	105,0	105,0
m	15°	15°	15°	15°	15°	15°
Cond. mm² min	6,0	6,0	6,0	25,0	25,0	25,0
Cond. mm² max	25,0	25,0	25,0	70,0	70,0	70,0

4 MB 123

Technical information

- Colour: bronze-green RAL 6031-F9
 - IEC 60309, EN 60309, VDE 0623, VG 96919

Plug TE-Plus with MULTI-GRIP

- Screwless terminals
- High-temperature-resistant contact carrier
- Nickel plated contacts
- With protective cap
- Special gland, simultaneous cable gland and seal
- Protection degree IP67

(Form CP)

QUICK CONNECT MULTI-GRIP



Ampere	Poles	Order no. Supply no. 5935-12-... VG-type-Nr. VG 96919...	230V 50-60 Hz	400V 50-60 Hz	400V 60 Hz	301-500Hz >50V	g
			3pol 4pol 5pol 6h 9h 9h	3pol 4pol 5pol 9h 6h 6h	4pol 5pol 11h 11h	3pol 4pol 5pol 2h 2h 2h	
16	3	Order no. 21220* Supply no. 5935-12-... VG-type-Nr. VG 96919...	312-5515 CP 017			210403 CP 039	180
16	4	Order no. 210404 Supply no. 5935-12-... VG-type-Nr. VG 96919...	CP 020	210077 CP 018	210405 CP 021	210406 CP 022	230
16	5	Order no. 21423* Supply no. 5935-12-... VG-type-Nr. VG 96919...	CP 002	21208* 300-3599 CP 001	21424* CP 003	21425* CP 004	265
32	3	Order no. 21221 Supply no. 5935-12-... VG-type-Nr. VG 96919...	CP 042			210408 CP 044	340
32	4	Order no. 210409 Supply no. 5935-12-... VG-type-Nr. VG 96919...	CP 025	210078 CP 023	210410 CP 026	210411 CP 027	380
32	5	Order no. 21426* Supply no. 5935-12-... VG-type-Nr. VG 96919...	CP 006	21209* 300-3596 CP 005	21427* 348-5139 CP 007	21380* 312-4197 CP 008	420



21208

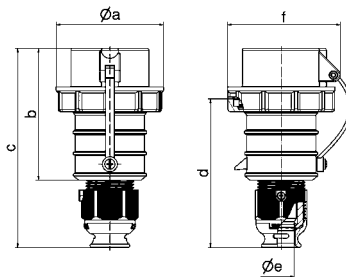

2 MB 95

Ampere	16	16	16	32	32	32
Poles	3	4	5	3	4	5
Ø a	70,0	78,0	86,0	94,0	94,0	101,0
b	103,5	104,0	105,5	127,0	127,0	129,5
c	153,5	154,0	160,5	187,0	187,0	193,5
d	111,0	111,0	119,0	136,0	136,0	138,5
Ø e	18,0	18,0	21,0	23,5	23,5	27,0
f	75,5	82,5	91,0	96,5	96,5	104,5
Cond. mm² min	1,0	1,0	1,0	2,5	2,5	2,5
Cond. mm² max	2,5	2,5	2,5	6,0	6,0	6,0

Plug TE with MULTI-GRIP

- Screw terminals
- High-temperature-resistant contact carrier
- Box terminals
- Nickel plated contacts
- Special gland, simultaneous cable gland and seal
- With protective cap
- Screwless enclosure connection, self locking
- Protection degree IP67

(Form CP)

MULTI-GRIP



Ampere	Poles	Order no. Supply no. 5935-12-... VG-type-Nr. VG 96919...	230V 50-60 Hz	400V 50-60 Hz	400V 60 Hz	301-500Hz >50V	g
			3pol 4pol 5pol 6h 9h 9h	3pol 4pol 5pol 9h 6h 6h	4pol 5pol 11h 11h	3pol 4pol 5pol 2h 2h 2h	
63	3	Order no. 210256 Supply no. 5935-12-... VG-type-Nr. VG 96919...	CP 047			210413 CP 049	695
63	4	Order no. 210414 Supply no. 5935-12-... VG-type-Nr. VG 96919...	CP 000	210263 CP 028	210415 CP 031	210417 CP 032	755
63	5	Order no. 21428* Supply no. 5935-12-... VG-type-Nr. VG 96919...	CP 010	21210* 300-5325 CP 009	21429* CP 0011	21430* CP 012	815
125	3	Order no. 210264 Supply no. 5935-12-... VG-type-Nr. VG 96919...	CP 052			210419 CP 054	1115
125	4	Order no. 210421 Supply no. 5935-12-... VG-type-Nr. VG 96919...	CP 035	210265 CP 033	210422 CP 036	210423 CP 037	1220
125	5	Order no. 21431* Supply no. 5935-12-... VG-type-Nr. VG 96919...	CP 014	21033* 327-8595 CP 013	21432* CP 015	21433* CP 016	1330



21210

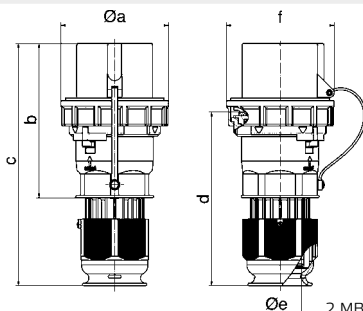

2 MB 107

Ampere	63	63	63	125	125	125
Poles	3	4	5	3	4	5
Ø a	113,5	113,5	113,5	126,0	126,0	126,0
b	169,0	169,0	169,0	185,0	185,0	185,0
c	250,0	250,0	250,0	286,0	286,0	286,0
d	171,0	171,0	171,0	206,0	206,0	206,0
Ø e	36,0	36,0	36,0	50,0	50,0	50,0
f	112,5	112,5	112,5	125,0	125,0	125,0
Cond. mm² min	6,0	6,0	6,0	16,0	16,0	16,0
Cond. mm² max	25,0	25,0	25,0	50,0	50,0	50,0

Appliance Inlet with Flange

- Screw terminals
- High-temperature-resistant contact carrier
- Nickel plated contacts
- With protective cap
- Flange 85 x 85 mm
- Protection degree IP67

(Form BP)



Ampere	Poles	Order no. Supply no. 5935-12-... VG-type-Nr. VG 96919...	230V 50-60 Hz			400V 50-60 Hz			400V 60 Hz			301-500Hz >50V			g
			3pol	4pol	5pol	3pol	4pol	5pol	4pol	5pol	3pol	4pol	5pol	each	
16	3	Order no. 27046* Supply no. 5935-12-... VG-type-Nr. VG 96919...	319-7028										27286	205	
			BP 013										BP 039		
16	4	Order no. 27287 Supply no. 5935-12-... VG-type-Nr. VG 96919...				27204	27288	27289						230	
			BP 020			BP 018	BP 021	BP 022							
16	5	Order no. 27104* Supply no. 5935-12-... VG-type-Nr. VG 96919...				2702*	27105*	27106*						260	
			BP 002			300-3598 BP 001	BP 003	BP 004							
32	3	Order no. 2745 Supply no. 5935-12-... VG-type-Nr. VG 96919...						27291						305	
			BP 042					BP 044							
32	4	Order no. 27292 Supply no. 5935-12-... VG-type-Nr. VG 96919...				27201	27293	27294						330	
			BP 025			BP 023	BP 026	BP 027							
32	5	Order no. 27107* Supply no. 5935-12-... VG-type-Nr. VG 96919...				2703*	27108*	27043*						365	
			BP 006			188-9997 BP 005	BP 007	312-4197 BP 008							



2703

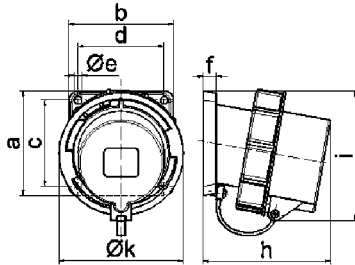

5 MB 31

Ampere	16	16	16	32	32	32
Poles	3	4	5	3	4	5
a	85,0	85,0	85,0	85,0	85,0	85,0
b	85,0	85,0	85,0	85,0	85,0	85,0
c	70,0	70,0	70,0	70,0	70,0	70,0
d	70,0	70,0	70,0	70,0	70,0	70,0
Ø e	6,3	6,3	6,3	6,3	6,3	6,3
f	11,0	11,0	11,0	11,0	11,0	11,0
h	94,0	94,0	94,0	105,0	105,0	105,0
i	94,0	97,0	101,0	103,0	103,0	107,0
k	70,5	78,5	86,5	94,0	94,0	101,5
Cond. mm² min	1,0	1,0	1,0	2,5	2,5	2,5
Cond. mm² max	2,5	2,5	2,5	6,0	6,0	6,0

Appliance Inlet with Flange

- Screw terminals
- High-temperature-resistant contact carrier
- Box terminals
- Nickel plated contacts
- With protective cap
- Flange 107 x 100 mm for 63A, 130 x 120 mm for 125A
- Protection degree IP67

(Form BP)



Ampere	Poles	Order no. Supply no. 5935-12-... VG-type-Nr. VG 96919...	230V 50-60 Hz			400V 50-60 Hz			400V 60 Hz			301-500Hz >50V			g
			3pol	4pol	5pol	3pol	4pol	5pol	4pol	5pol	3pol	4pol	5pol	each	
63	3	Order no. 27267 Supply no. 5935-12-... VG-type-Nr. VG 96919...											27295	630	
			BP 047										BP 049		
63	4	Order no. 27296 Supply no. 5935-12-... VG-type-Nr. VG 96919...				27268	27297	27298						695	
			BP 030			BP 028	BP 031	BP 032							
63	5	Order no. 27109* Supply no. 5935-12-... VG-type-Nr. VG 96919...				2704*	27110*	27045*						750	
			BP 010			BP 009	BP 011	BP 012							
125	3	Order no. 27269 Supply no. 5935-12-... VG-type-Nr. VG 96919...						27299						1010	
			BP 052					BP 054							
125	4	Order no. 27300 Supply no. 5935-12-... VG-type-Nr. VG 96919...				27270	27301	27302						1125	
			BP 035			BP 033	BP 036	BP 037							
125	5	Order no. 27303 Supply no. 5935-12-... VG-type-Nr. VG 96919...				27102	27304	27305						1220	
			BP 015			300-5323 BP 014	BP 016	321-5242 BP 017							



2704

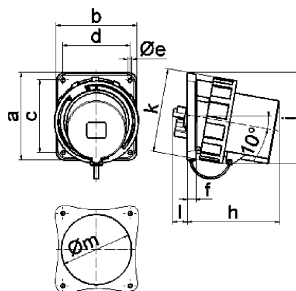

5 MB 100

Ampere	63	63	63	125	125	125
Poles	3	4	5	3	4	5
a	107,0	107,0	107,0	130,0	130,0	130,0
b	100,0	100,0	100,0	120,0	120,0	120,0
c	85,0	85,0	85,0	108,0	108,0	108,0
d	77,0	77,0	77,0	100,0	100,0	100,0
Ø e	6,5	6,5	6,5	6,5	6,5	6,5
f	12,0	12,0	12,0	13,0	13,0	13,0
h	142,0	142,0	142,0	134,0	134,0	134,0
i	124,0	124,0	124,0	138,0	138,0	138,0
k	113,5	113,5	113,5	126,0	126,0	126,0
l	-	-	-	23,0	23,0	23,0
Ø m	-	-	-	105,0	105,0	105,0
Cond. mm² min	6,0	6,0	6,0	16,0	16,0	16,0
Cond. mm² max	16,0	16,0	16,0	50,0	50,0	50,0

Technical information

- Colour: bronze-green RAL 6031-F9
 - IEC 60309, EN 60309, VDE 0623, VG 96919

Appliance Inlet with Flange

- Screw terminals
- High-temperature-resistant contact carrier
- Nickel plated contacts
- With protective cap
- Flange 85 x 85 mm
- Protection degree IP67

(Form AP)



2897



Ampere	Poles	Order no.	Supply no. 5935-12-... VG-type-Nr. VG 96919-...	230V 50-60 Hz		400V 50-60 Hz		400V 60 Hz		301-500Hz >50V			g
				3pol	4pol	5pol	3pol	4pol	5pol	4pol	5pol	3pol	
16	3	2892	AP 037	6h	9h	9h	9h	11h	11h	2h	2h	2h	each
16	4	2893	AP 017										210
16	5	2894	AP 001										259
32	3	2895	AP 042										302
32	4	2896	AP 022										
32	5	2897	AP 005										360

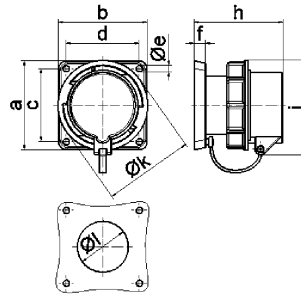

Ampere	16	16	16	32	32	32
Poles	3	4	5	3	4	5
a	85,0	85,0	85,0	85,0	85,0	85,0
b	85,0	85,0	85,0	85,0	85,0	85,0
c	70,0	70,0	70,0	70,0	70,0	70,0
d	70,0	70,0	70,0	70,0	70,0	70,0
Ø e	6,3	6,3	6,3	6,3	6,3	6,3
f	11,0	11,0	11,0	11,0	11,0	11,0
h	84,0	84,0	85,0	94,0	94,0	94,0
i	82,5	86,0	91,0	96,5	96,05	104,0
Ø k	70,5	78,5	86,5	94,0	94,0	101,5
Ø l	49,0	49,0	49,0	49,0	49,0	49,0
Cond. mm² min	1,0	1,0	1,0	2,5	2,5	2,5
Cond. mm² max	2,5	2,5	2,5	6,0	6,0	6,0

5 MB 73

Appliance Inlet with flange

- Screw terminals
- High-temperature-resistant contact carrier
- Box terminals
- Nickel plated contacts
- With protective cap
- Flange 110 x 106 mm for 63A, flange 120 x 120 mm for 125A
- Protection degree IP67

(Form AP)



2853



Ampere	Poles	Order no.	Supply no. 5935-12-... VG-type-Nr. VG 96919-...	230V 50-60 Hz		400V 50-60 Hz		400V 60 Hz		301-500Hz >50V			g
				3pol	4pol	5pol	3pol	4pol	5pol	4pol	5pol	3pol	
63	3	28042	AP 047	6h	9h	9h	9h	11h	11h	2h	2h	2h	each
63	4	28000	AP 027										
63	5	2853	AP 009										725
125	3	28043	AP 052										
125	4	28044	AP 032										
125	5	28045	AP 013										

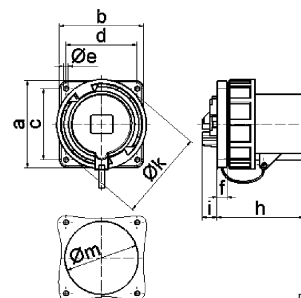

Ampere	63	63	63	125	125	125
Poles	3	4	5	3	4	5
a	110,0	110,0	110,0	120,0	120,0	120,0
b	106,0	106,0	106,0	120,0	120,0	120,0
c	90,0	90,0	90,0	100,0	100,0	100,0
d	90,0	90,0	90,0	100,0	100,0	100,0
Ø e	5,5	5,5	5,5	6,5	6,5	6,5
f	13,0	13,0	13,0	13,0	13,0	13,0
h	114,0	114,0	114,0	121,0	121,0	121,0
i	19,0	19,0	19,0	20,0	20,0	20,0
Ø k	113,5	113,5	113,5	126,0	126,0	126,0
Ø m	93,0	93,0	93,0	104,0	104,0	104,0
Cond. mm² min	6,0	6,0	6,0	16,0	16,0	16,0
Cond. mm² max	16,0	16,0	16,0	50,0	50,0	50,0

5 MB 101

Connector TE-Plus with MULTI-GRIP

- Screwless terminals
- Kontex contact
- High-temperature-resistant contact carrier
- Nickel plated contacts
- Special gland, simultaneous cable gland and seal
- Protection degree IP67

(Form DS)

QUICK CONNECT
MULTI-GRIP



Ampere	Poles	Order no. Supply no. 5935-12-... VG-type-Nr. VG 96919...	230V 50-60 Hz	400V 50-60 Hz	400V 60 Hz	301-500Hz >50V	g each
			3pol 4pol 5pol 6h 9h 9h	3pol 4pol 5pol 9h 6h 6h	4pol 5pol 11h 11h	3pol 4pol 5pol 2h 2h 2h	
16	3	Order no. 31162* Supply no. 5935-12-... VG-type-Nr. VG 96919...	312-5516			310163	180
			DS 017			DS 039	
16	4	Order no. 310165 Supply no. 5935-12-... VG-type-Nr. VG 96919...	DS 020	31865	310167	310168	215
				DS 018	DS 021	DS 022	
16	5	Order no. 31318* Supply no. 5935-12-... VG-type-Nr. VG 96919...	DS 002	31150*	31319*	31320*	255
				DS 001	DS 003	DS 004	
32	3	Order no. 31032 Supply no. 5935-12-... VG-type-Nr. VG 96919...				310194	325
						DS 044	
32	4	Order no. 310169 Supply no. 5935-12-... VG-type-Nr. VG 96919...	DS 025	31866	310171	310172	355
				DS 023	DS 026	DS 027	
32	5	Order no. 31321* Supply no. 5935-12-... VG-type-Nr. VG 96919...	DS 006	31151*	31322*	31323*	410
				300-3597	DS 007	312-4196	
					DS 008		



3151

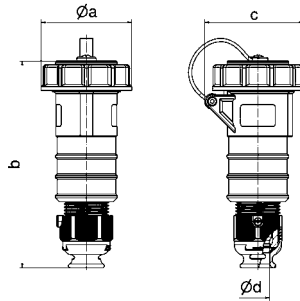

Ampere	16	16	16	32	32	32
Poles	3	4	5	3	4	5
Ø a	70,5	78,0	86,5	94,0	94,0	101,5
b	161,0	161,0	168,0	196,0	196,0	200,0
c	77,0	83,0	93,0	99,0	99,0	107,0
Ø d	18,0	18,0	21,0	23,0	23,0	27,0
Cond. mm² min	1,0	1,0	1,0	2,5	2,5	2,5
Cond. mm² max	2,5	2,5	2,5	6,0	6,0	6,0

3 MB 70

Connector with MULTI-GRIP

- Screw terminals
- High-temperature-resistant contact carrier
- Box terminals
- Kontex contact
- Nickel plated contacts
- Special gland, simultaneous cable gland and seal
- Screwless enclosure connection, self locking
- Protection degree IP67

(Form DS)

MULTI-GRIP



Ampere	Poles	Order no. Supply no. 5935-12-... VG-type-Nr. VG 96919...	230V 50-60 Hz	400V 50-60 Hz	400V 60 Hz	301-500Hz >50V	g each
			3pol 4pol 5pol 6h 9h 9h	3pol 4pol 5pol 9h 6h 6h	4pol 5pol 11h 11h	3pol 4pol 5pol 2h 2h 2h	
63	3	Order no. 310058 Supply no. 5935-12-... VG-type-Nr. VG 96919...				310177	760
				DS 047		DS 049	
63	4	Order no. 310174 Supply no. 5935-12-... VG-type-Nr. VG 96919...	DS 030	31877	310175	310176	770
				DS 028	DS 031	DS 032	
63	5	Order no. 31324* Supply no. 5935-12-... VG-type-Nr. VG 96919...	DS 010	31152*	31325*	31326*	785
				300-5326	DS 009	DS 011	
125	3	Order no. 310059 Supply no. 5935-12-... VG-type-Nr. VG 96919...				310179	1160
				DS 052		DS 054	
125	4	Order no. 310180 Supply no. 5935-12-... VG-type-Nr. VG 96919...	DS 035	310060	310182	310183	1255
				DS 033	DS 036	DS 037	
125	5	Order no. 31327* Supply no. 5935-12-... VG-type-Nr. VG 96919...	DS 014	31027*	31328*	31329*	1350
				322-8597	DS 015	DS 016	



31152

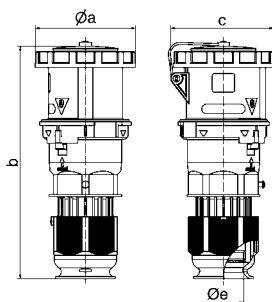

Ampere	63	63	63	125	125	125
Poles	3	4	5	3	4	5
Ø a	110,0	110,0	110,0	125,0	125,0	125,0
b	263,0	263,0	263,0	300,0	300,0	300,0
c	113,0	113,0	113,0	128,0	128,0	128,0
Ø d	36,0	36,0	36,0	50,0	50,0	50,0
Cond. mm² min	6,0	6,0	6,0	16,0	16,0	16,0
Cond. mm² max	16,0	16,0	16,0	50,0	50,0	50,0

3 MB 125

Technical information

- Colour: bronze-green RAL 6031-F9
- VDE 0623, VG 96919

Domestic Panel Mounting Socket Outlet

- Screw terminals
- Nickel plated contacts
- 16A/230 V~
- Flange 75 x 75 mm
- Protection degree IP68

(Form AS)

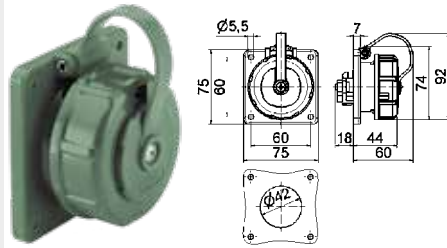

7108

18 MB 19

	Ref. no.	Supply no.	VG-type-Nr.
		5935-12-...	VG 96926...

german system	7108*	312-5115	AS 001
belg./ french system	7185		

Domestic Panel Mounting Socket Outlet

- Screw terminals
- Nickel plated contacts
- 16A/230 V~
- Protection degree IP68

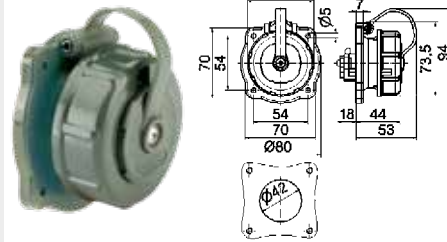

7114

18 MB 20

	Ref. no.
german system	7114
belg./ french system	71031

Domestic Panel Mounting Socket Outlet

- Screw terminals
- Nickel plated contacts
- 16A/230 V~
- Protection degree IP68

(Form BS)

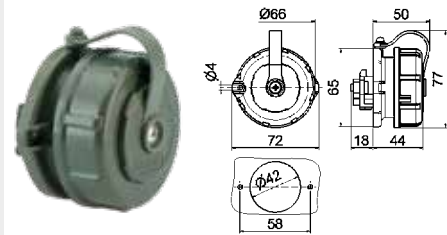

7115

18 MB 21

	Ref. no.	Supply no.	VG-type-Nr.
		5935-12-...	VG 96926...

german system	7115*	314-4770	BS 001
belg./ french system	7186		

Domestic Plug

- Screw terminals
- Nickel plated contacts
- 16A/230 V~
- With closure cap
- Protection degree IP68

(Form CP)

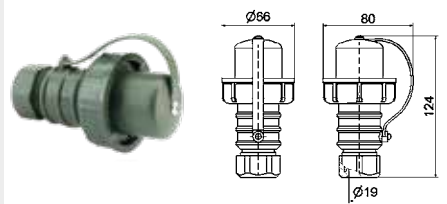

735

18 MB 18

	Ref. no.	Supply no.	VG-type-Nr.
		5935-12-...	VG 96926...

	735*	141-3149	CP 001
--	-------------	----------	--------

Domestic Appliance Inlet with Flange

- Screw terminals
- Nickel plated contacts
- 16A/230 V~
- With closure cap
- Flange 75 x 75 mm
- Protection degree IP68

(Form AP)

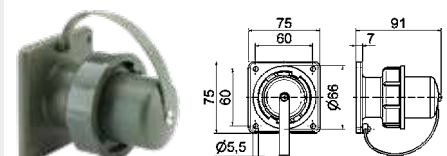

753

18 MB 16

	Ref. no.	Supply no.	VG-type-Nr.
		5935-12-...	VG 96926...

	753*	340-7272	AP 001
--	-------------	----------	--------

Technical information

- Colour: bronze-green RAL 6031-F9
 - VDE 0623, VG 96919

Domestic Connector

- Screw terminals
- Nickel plated contacts
- 16A/230 V~
- Protection degree IP68

(Form DS)

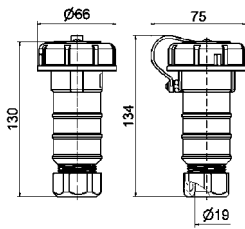

745

18 MB 26

Ref. no. Supply no. VG-type-Nr.
 5935-12-... VG 96926...

german system	745*	314-4771	DS 001
belg./ french system	7424		

Domestic Three-way Connector

- Screw terminals
- Nickel plated contacts
- 16A/230 V~
- With closure cap, hanging bracket, cable gland
- Protection degree IP68

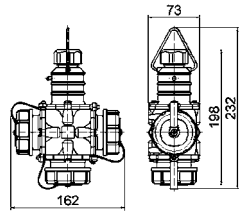

7400

18 MB 27

Ref. no. Supply no. VG-type-Nr.
 5935-12-... VG 96926...

german system	7400		
belg./ french system	7423		

Hinged Window

- Self-closing
- With touch protection
- With option for lock set

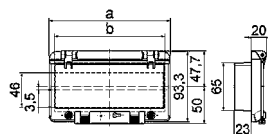

58110

30 MB 96

Module units	Dimension a	Dimension b	Ref. no.
2	55,0	40,5	580138
4	91,0	76,5	58388
6	127,0	112,5	58590
8	162,0	147,5	58110
12	234,0	220,0	58111
13	257,5	248,5	58387

Hinged Window

- Self-closing
- Without touch protection
- With option for lock set

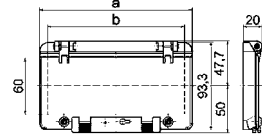

58502

30 MB 95

Module units	Dimension a	Dimension b	Ref. no.
2	55,0	37,0	58511
4	91,0	73,0	580020
6	127,0	109,0	58503
8	162,0	144,5	58502
12	234,0	217,0	58602
13	257,5	240,0	58607

Hinged Window

- Self-closing
- With touch protection
- With option for lock set
- With mounting bracket

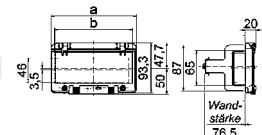

580143

30 MB 97

Module units	Dimension a	Dimension b	Ref. no.
2	55,0	40,5	580137
4	91,0	76,5	58517
6	127,0	112,5	580141
8	162,0	147,5	580143
12	234,0	220,0	580144
13	257,5	248,5	580145

Closure Cap

- for domestic plug
- Form H



8320

Ref. no. VG-Typ-Nr.
8320* H-16

Closure Cap

- für domestic connector
- Form G



8319

Ref. no. VG-type-Nr.
8319* G-16

Closure Cap with Strap

- for CEE plugs



8337

Ampere / Poles	Ref. no.	Supply no. 5935-12-...	VG-type-Nr. VG 96926...
16A / 3p	8335		
16A / 4p	8336		
16A / 5p	8337		
32A / 3p, 4p	8338		
32A / 5p	8339		
63A / 3p, 4p, 5p	8340		
125A / 3p, 4p, 5p	8341		

Closure Cap with Strap

- for CEE connector
- for CEE Panel Mounting Socket
Outlet



8330

Ampere / Poles	Ref. no.	Supply no. 5935-12-...	VG-type-Nr. VG 96926...
16A / 3p	8328		
16A / 4p	8329		
16A / 5p	8330		
32A / 3p, 4p	8331		
32A / 5p	8332		
63A / 3p, 4p, 5p	8333		
125A / 3p, 4p, 5p	8334		

Closure Cap

- for CEE plugs
- Form G



8326

Ampere / Poles	Ref. no.	Supply no. 5935-12-...	VG-type-Nr. VG 96926...
16A / 3p	8318*		G-16-3
16A / 4p	8326		G-16-4
16A / 5p	8314*		G-16-5
32A / 3p, 4p	8327		G-32-4
32A / 5p	8315*	304-8143	G-32-5
63A / 3p, 4p, 5p	8316*		G-63-5
125A / 3p, 4p, 5p	8317*		G-125-5

Closure Cap

- for CEE connector
- Form F



8309

Ampere / Poles	Ref. no.	Supply no. 5935-12-...	VG-type-Nr. VG 96926...
16A / 3p	8313*		F-16-3
16A / 4p	8324		F-16-4
16A / 5p	8309*		F-16-5
32A / 3p, 4p	8325		F-32-4
32A / 5p	8310*		F-32-5
63A / 3p, 4p, 5p	8311*		F-63-5
125A / 3p, 4p, 5p	8312*		F-125-5



Technical information

- IEC 60309, EN 60309, VDE 0623

Panel Mounting Socket Outlet QUICK-CONNECT

- Screwless terminals
- Kontex contact
- Nickel plated contacts
- Flange 75 x 75 mm
- Protection degree IP44



QUICK-CONNECT

130274

2P+E Ampere	3P+E Poles	3+N+E Poles	230V 50-60 Hz	400V 50-60 Hz	Quantity	Each
16	3		3pol 6h 4pol 9h 5pol 9h	3pol 9h 4pol 6h 5pol 6h	10	110
16	4				10	150
16	5				10	170
32	3		130269		10	190
32	4				10	205
32	5				10	225

Panel Mounting Socket Outlet

- Screw terminals
- Flange 107 x 100 mm
- Kontex contact
- Nickel plated contacts
- Box terminals
- Protection degree IP44



130276

2P+E Ampere	3P+E Poles	3+N+E Poles	230V 50-60 Hz	400V 50-60 Hz	Quantity	Each
63	3		3pol 6h 4pol 9h 5pol 9h	3pol 9h 4pol 6h 5pol 6h	5	415
63	5				5	490

Panel Mounting Socket Outlet

- Screw terminals
- Flange 107 x 100 mm
- Kontex contact
- Nickel plated contacts
- Box terminals
- Protection degree IP67



130276

2P+E Ampere	3P+E Poles	3+N+E Poles	230V 50-60 Hz	400V 50-60 Hz	Quantity	Each
63	3		3pol 6h 4pol 9h 5pol 9h	3pol 9h 4pol 6h 5pol 6h	5	415
63	5				5	570

Panel Mounting Socket QUICK-CONNECT

- Screwless terminals
- 20° angled
- Kontex contact
- Nickel plated contacts
- Flange 85 x 85 mm
- Protection degree IP44



QUICK-CONNECT

120441

2P+E Ampere	3P+E Poles	3+N+E Poles	230V 50-60 Hz	400V 50-60 Hz	Quantity	Each
16	3		3pol 6h 4pol 9h 5pol 9h	3pol 9h 4pol 6h 5pol 6h	10	120
16	4				10	140
16	5				10	145
32	3		120436		10	200
32	4				10	230
32	5				10	265

Stecker QUICK-CONNECT

- schraublose Klemmen
- vernickelte Kontakte
- Gehäuseverbindung mit Gewinde und Rastverschluss
- spezielle Zugentlastungsverschraubung
- Schutzart IP44



QUICK-CONNECT MULTI-GRIP

210791

2P+E Ampere	3P+E Poles	3+N+E Poles	230V 50-60 Hz	400V 50-60 Hz	Quantity	Each
16	3		3pol 6h 4pol 9h 5pol 9h	3pol 9h 4pol 6h 5pol 6h	10	
16	4				10	
16	5				10	
32	3		211103		10	
32	4				10	
32	5				10	

1
2
3
4
5
6
7
8

Plug TE with MULTI-GRIP

- Screw terminals
- Box terminals
- High-temperature-resistant contact carrier
- Nickel plated contacts
- Enclosure connection with thread and snap-in lock
- Special gland, simultaneous cable gland and seal
- Protection degree IP44



MULTI-GRIP

210792

2P+E Ampere	3P+E Poles	230V 50-60 Hz			400V 50-60 Hz			Quantity	g
		3pol 6h	4pol 9h	5pol 9h	3pol 9h	4pol 6h	5pol 6h		
63	3	210735					5	535	
63	4				211102			5	595
63	5				210792			5	650

Plug TE with MULTI-GRIP

- Screw terminals
- Box terminals
- High-temperature-resistant contact carrier
- Nickel plated contacts
- Screwless enclosure connection, snap-in lock
- Special gland, simultaneous cable gland and seal
- Protection degree IP67



MULTI-GRIP

210711

2P+E Ampere	3P+E Poles	230V 50-60 Hz			400V 50-60 Hz			Quantity	g
		3pol 6h	4pol 9h	5pol 9h	3pol 9h	4pol 6h	5pol 6h		
63	3	211127					5	535	
63	5				210710			5	715
125	5				210711			5	1235

Appliance Inlet QUICK-CONNECT with Flange

- Screwless terminals
- Kontex contact
- Nickel plated contacts
- Flange 75 x 75 mm
- Protection degree IP44



QUICK-CONNECT

28298

2P+E Ampere	3P+E Poles	230V 50-60 Hz			400V 50-60 Hz			Quantity	g
		3pol 6h	4pol 9h	5pol 9h	3pol 9h	4pol 6h	5pol 6h		
16	3	28312					10	90	
16	4				28313			10	105
16	5				28314			10	125
32	3	28315					10	145	
32	4				28316			10	165
32	5				28298			10	195

Connector QUICK-CONNECT with MULTI-GRIP

- Screwless terminals
- Enclosure connection with thread and snap-in lock
- Kontex contact
- Nickel plated contacts
- Special gland, simultaneous cable gland and seal
- Protection degree IP44



QUICK-CONNECT
MULTI-GRIP

310517

2P+E Ampere	3P+E Poles	230V 50-60 Hz			400V 50-60 Hz			Quantity	g
		3pol 6h	4pol 9h	5pol 9h	3pol 9h	4pol 6h	5pol 6h		
16	3	310512					10	120	
16	4				310607			10	160
16	5				310515			10	165
32	3	310513					10	240	
32	4				310489			10	260
32	5				310517			10	300

Connector with MULTI-GRIP

- Screw terminals
- Box terminals
- High-temperature-resistant contact carrier
- Kontex contact
- Nickel plated contacts
- Screwless enclosure connection, snap-in lock
- Special gland, simultaneous cable gland and seal
- Protection degree IP44



MULTI-GRIP

310518

2P+E Ampere	3P+E Poles	230V 50-60 Hz			400V 50-60 Hz			Quantity	g
		3pol 6h	4pol 9h	5pol 9h	3pol 9h	4pol 6h	5pol 6h		
63	3	310488					5	590	
63	4				310749			5	630
63	5				310518			5	670

Technical information

- IEC 60309, EN 60309, VDE 0623

Connector with MULTI-GRIP

- Screw terminals
- Box terminals
- High-temperature-resistant contact carrier
- Kontex contact
- Nickel plated contacts
- Enclosure connection with thread and snap-in lock
- Special gland, simultaneous cable gland and seal
- Protection degree IP67



MULTI-GRIP

310466

		230V 50-60 Hz			400V 50-60 Hz			Quantity			
		3p+E Ampere	3p+E Poles	3p+E Poles	3pol 6h	4pol 9h	5pol 9h	3pol 9h	4pol 6h	5pol 6h	Each
63	3	310771						5			650
63	5				310465			5			725
125	5				310466			5			1300

Cable Gland MULTI-GRIP with Additional Strain Relief

- In black for plugs and connectors with MULTI-GRIP cable gland



MULTI-GRIP

	Ref. no.
for 16A / 3p, 4p TE + TE Plus	
16A / 3p, 4p, 5p QC + TLS	29951
for 16A / 5p TE + TE Plus	29151
for 32A / 5p TE + TE Plus	29152
for 63A / 3p, 4p, 5p TE + TE Plus	29153
for 125A / 3p, 4p, 5p TE	29154

Domestic Panel Mounting Socket Outlet

- 16A 250V ~
- Screw terminals
- Nickel plated contacts
- Without hinged lid
- Connection at rear
- Protection degree IP20

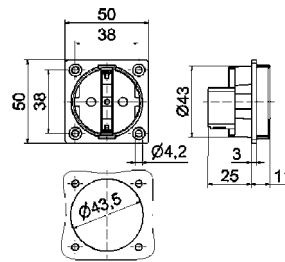

Color	Ref. no.	Qty
black	714	20

714

18 MB 1

Domestic Panel Mounting Socket Outlet stationary use

- 16A 250V ~
- Screwless terminals
- Nickel plated contacts
- With moulded flange seal
- Flange 50 x 50 mm
- Mounting dimension 38 x 38 mm
- Connection terminal in accordance with BGV A2
- Polyamide 6 contact carrier
- Protection degree IP54

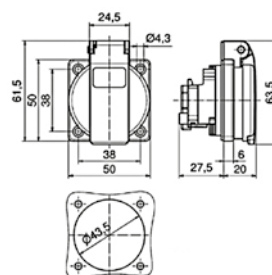

Color	Ref. no.	Qty
QUICK-CONNECT black	71101	20
Screw term. black	71097	20

71101

18 MB 102

Domestic Panel Mounting Socket Outlet mobile use

- 16A 250V ~
- Screwless terminals
- Nickel plated contacts
- With moulded flange seal
- according to DIN/VDE 620/1 for portable distribution systems
- Protection degree IP54

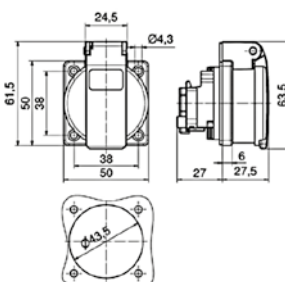

Color	Ref. no.	Qty
QUICK-CONNECT black	71104	20

QUICK-CONNECT

71104

18 MB 104

Domestic Plug

- With MULTI-GRIP cable gland
- Spacious connection area
- Also suitable for Belgian/French system
- Protection degree IP44



7372

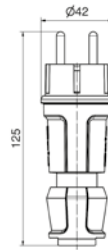

18 MB 119

Color	Ref. no.	Qty
black	7372	20

MULTI-GRIP

Domestic Connector

- With Multi-Grip cable gland
- Spacious connection area
- Protection degree IP54



7488

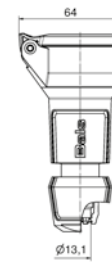
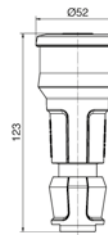

18 MB 120

Color	Ref. no.	Qty
black	7488	20

In the case of Domestic Connectors with shutter add **09** to the end of the order number.

MULTI-GRIP



1

2

3

4

5

6

7

8

Technical information

- IEC 60309, EN 60309, VDE 0623
- Enclosure, insert and hinged lid made of high-grade plastic

Surface Mounting Socket Outlet

- Screw terminals
- 16A 230V 3p
- Lockable using padlock with bar diameter 5 mm
- Protection degree IP44



119

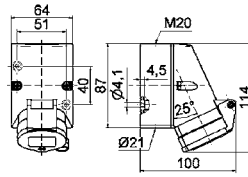

1 MB 53

Order no.



Qty

119

10

Panel Mounting Socket Outlet QUICK-CONNECT

- Screwless terminals
- Kontex contact
- 16A 230V 3p
- 20° angled
- Lockable by a padlock shackle diameter 5 mm
- Flange 74 x 62 mm
- Drill hole 60 x 52 mm
- Protection degree IP44



12990

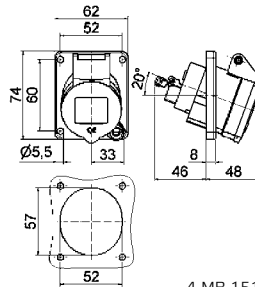

4 MB 151

Ref. no.



Qty

12990

10

QUICK-CONNECT

Panel Mounting Socket Outlet QUICK-CONNECT

- Screwless terminals
- Kontex contact
- 16A 230V 3p
- 20° angled
- Flange 74 x 62 mm
- Drill hole 60 x 52 mm
- Protection degree IP44



12772

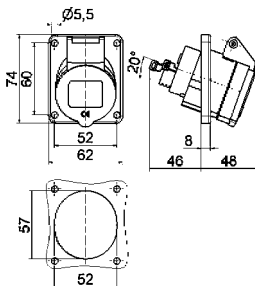

4 MB 246

Ref. no.



Qty

12772

10

QUICK-CONNECT

Caravan Flush Mounting Inlets

- Screw terminals
- 16A 230V 3p
- Swing-out design
- Protection degree IP44



251

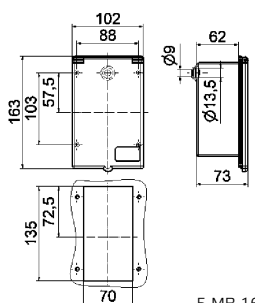

5 MB 16

Ref. no.



Qty

251

10

Caravan Flush Mounting Inlets

- Screw terminals
- 16A 230V 3p
- Swing-out design
- With rubber seal and frame
- For intermediate installation
- Protection degree IP44



254

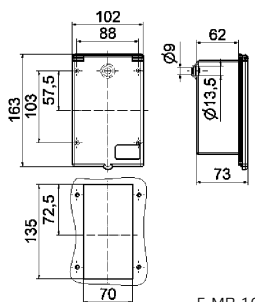

5 MB 16

Color

Ref. no.



Qty

white

254

10

brown

258

10

black

255

10

Technical information

- IEC 60309, EN 60309, VDE 0623
- Enclosure, insert and hinged lid made of high-grade plastic

Angled Plug

- Screw terminals
- 16A 230V 3p
- With short cable sleeve
- Protection degree IP44

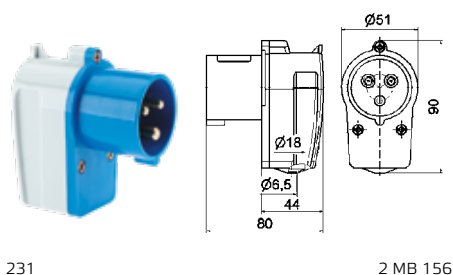

231

2 MB 156

Order no.



Qty

231

10

Plug

- Screw terminals
- 16A 230V 3p
- With short cable sleeve
- Lockable by a padlock shackle diameter 5 mm
- Protection degree IP44

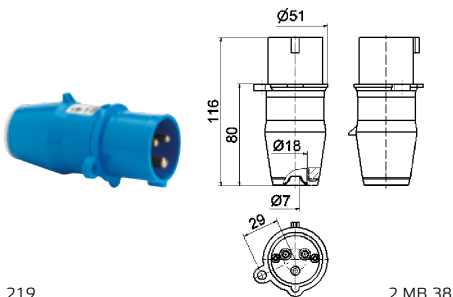

219

2 MB 38

Ref. no.



Qty

219

10

Plug QUICK-CONNECT with MULTI-GRIP

- Screwless terminals
- Screwless enclosure connection, self locking
- Special gland, simultaneous cable gland and seal
- 16A 230V 3p
- Protection degree IP44

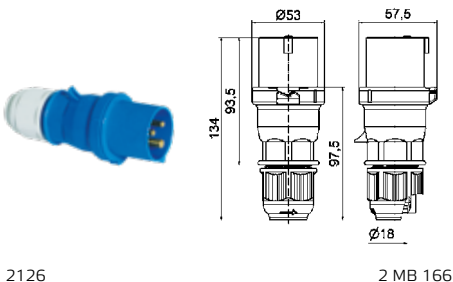

2126

2 MB 166

Ref. no.



Qty

2126

10

Surface Mounting Appliance Inlet

- Screw terminals
- Cable entry 1x at top (open), 1x at bottom (closed)
- 16A 230V 3p
- Protection degree IP44

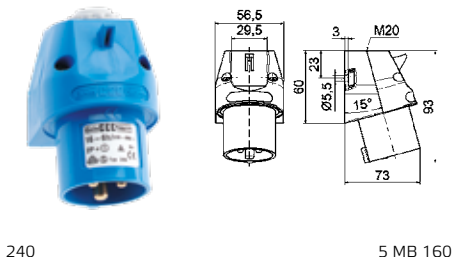

240

5 MB 160

Ref. no.



Qty

240

10

Surface Mounting Appliance Inlet QUICK-CONNECT

- Screwless terminals
- Cable entry 1x at top (open), 1x at bottom (closed)
- 16A 230V 3p
- Protection degree IP44

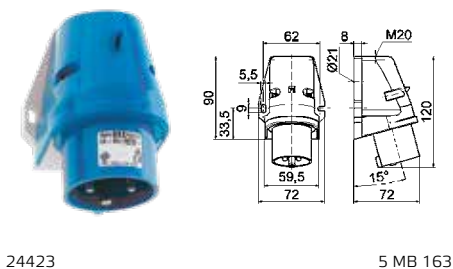

24423

5 MB 163

Ref. no.



Qty

24423

10

QUICK-CONNECT

Technical information

- IEC 60309, EN 60309, VDE 0623
- Enclosure, insert and hinged lid made of high-grade plastic

Surface Mounting Appliance Inlet

- Screw terminals
- Cable entry 1x at top (open), 1x at bottom (closed)
- 16A 230V 3p
- With self-closing hinged lid
- Protection degree IP44

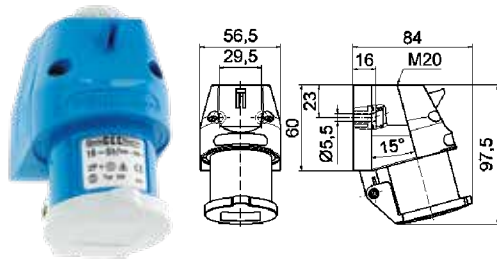

5 MB 161

Ref. no.



Qty

242 10

Surface Mounting Appliance Inlet

- Screw terminals
- 16A 230V 3p
- Cable entry 1x at top (open), 1x at bottom (closed)
- With closure cap on a plastic strap
- Protection degree IP44

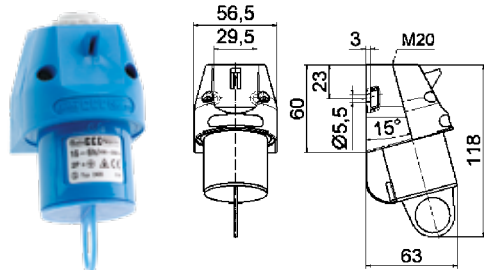

5 MB 162

Ref. no.



Qty

2400 10

Connector QUICK-CONNECT with MULTI-GRIP

- Screwless terminals
- 16A 230V 3p
- Screwless enclosure connection, snap-in lock
- Special gland, simultaneous cable gland and seal
- Protection degree IP44

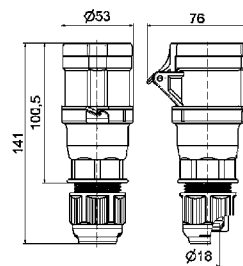

3 MB 110

Ref. no.



Qty

3126 10

QUICK-CONNECT
MULTI-GRIP

Adapter Plug

- Protection degree IP44



8615

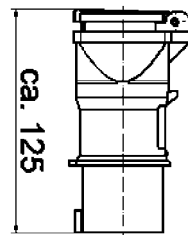

2 MB 39

Ref. no.



Qty

CEE plug
16A/230V/3p to
Domestic sockets
16A/230V~ german
earthing system

8615 10

CEE plug
16A/230V /3p to
Domestic sockets
16A/230V~ belg./
french system

8614 10

Domestic Plug

- With MULTI-GRIP cable gland
- Spacious connection area
- Also suitable for Belgian/French system
- Protection degree IP44



7370

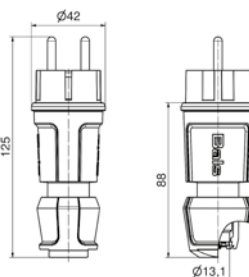

18 MB 119

Color

Ref. no.



Qty

blue **7370** 20

grey **7371** 20

black **7372** 20

red **7373** 20

MULTI-GRIP



Technical information

- IEC 60309, EN 60309, VDE 0623
- Enclosure, insert and hinged lid made of high-grade plastic

Domestic Connector

- With MULTI-GRIP cable gland
- Spacious connection area
- Protection degree IP54
- Type F - German standard

In the case of Domestic Connectors with shutter add **09** to the end of the order number.



MULTI-GRIP



7486

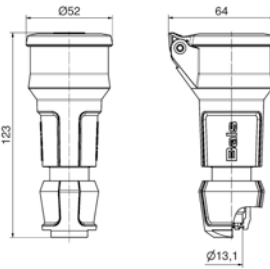

18 MB 120

Ref. no.



Qty

blue	7486	20
grey	7487	20
black	7488	20
red	7489	20

Domestic Connector

- With MULTI-GRIP cable gland
- Spacious connection area
- Protection degree IP54
- Type E Belgian/ French standard

In the case of Domestic Connectors with shutter add **09** to the end of the order number.



MULTI-GRIP



7490

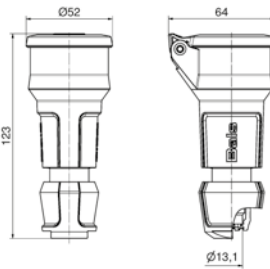

18 MB 120

Ref. no.



Qty

blue	7490	20
grey	7491	20
black	7492	20
red	7493	20

Extension Lead

- Protection degree IP44

*deviating from VDE 0100 Part 708 Section 4



812

CEE plug 16A 230V 3p and CEE connector 16A 230V 3p

Domestic plug and connector

Cable	Length	Ref. no.	Qty
H07RN-F3G1,5*	10m	812	1
H07RN-F3G2,5	10m	813	1
H07RN-F3G1,5*	15m	814	1
H07RN-F3G2,5	15m	815	1
H07RN-F3G1,5*	20m	816	1
H07RN-F3G2,5	20m	817	1
H07RN-F3G2,5	1,5m	8178	1

VARIABOX-S

- With four Domestic sockets 16A 250V ~ (German standard)
- 162 mm max. depth with components
- Ready wired for installation
- Cable entry:
Top: 1x M12, 1x M20, 2x M25 open
Bottom: 1x M12, 1x M20, 2x M25

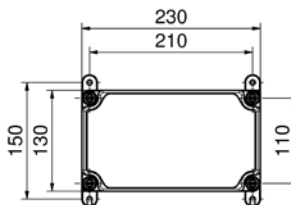

30 MB 208

Bestell-Nr. **89006**





TLS-Series

Surface Mounting Socket
Outlets



Page 236

Panel Mounting Socket
Outlets



Page 236 - 237

Plugs



Page 238

Connectors



Page 239

Empty Enclosures

Plastic Enclosures



Page 240

Accessories



Page 241

1

2

3

4

5

6

7

8

Surface Mounting Socket Outlet

- Screw terminals
- Cable entry 1x at top (open) and 1x at bottom (closed)
- Protection degree IP44

Ampere	Poles	110V	230V	400V	500V	>50V	>50V	Quantity	Each
		50-60 Hz	50-60 Hz	50-60 Hz	50-60 Hz	100-300Hz	301-500Hz		
		3pol 4pol 5pol	3pol 4pol 5pol	3pol 4pol 5pol	3pol 4pol 5pol	3pol 4pol 5pol	3pol 4pol 5pol		
		4h 4h 4h	6h 9h 9h	9h 6h 6h	7h 7h 7h	10h 10h 10h	2h 2h 2h		
16	3	11897	11765					10	175
16	4	11722	11652	11645	11723			10	220
16	5	11724	11725	100	11726		110129	10	240
32	3	11832	11651					10	275
32	4	11735	11653	11646	11736	11836	110130	10	285
32	5	11737	11738	101	11739			10	310



101

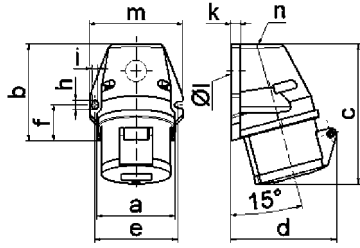

1 MB 19

Ampere	Poles	16	16	16	32	32	32
		3	4	5	3	4	5
a		59,5	72,4	72,4	79,1	79,1	79,1
b		90,0	90,0	90,0	92,0	92,0	92,0
c		130,0	130,0	131,0	142,0	142,0	142,0
d		85,0	96,0	98,0	103,0	103,0	106,0
e		62,0	77,0	77,0	84,0	84,0	84,0
f		33,5	33,5	33,5	30,0	30,0	30,0
h		9,0	9,0	9,0	9,0	9,0	9,0
i		5,5	5,5	5,5	5,5	5,5	5,5
k		8,0	9,0	9,0	9,0	9,0	9,0
ø l		21,0	21,0	21,0	21,0	21,0	21,0
m		72,0	87,0	87,0	94,0	94,0	94,0
n		M20	M25	M25	M25	M25	M25
Cond. mm² min		1,5	1,5	1,5	2,5	2,5	2,5
Cond. mm² max		4	4	4	10	10	10

Surface Mounting Socket Outlet

- Screw terminals
- Cable entry 1x at top (open), 2x at bottom (closed)
- Base rotatable by 180°
- 4 mounting holes in enclosure base
- Suitable for through wiring with special terminals
- Protection degree IP44

Ampere	Poles	110V	230V	400V	500V	>50V	>50V	Quantity	Each
		50-60 Hz	50-60 Hz	50-60 Hz	50-60 Hz	100-300Hz	301-500Hz		
		3pol 4pol 5pol	3pol 4pol 5pol	3pol 4pol 5pol	3pol 4pol 5pol	3pol 4pol 5pol	3pol 4pol 5pol		
		4h 4h 4h	6h 9h 9h	9h 6h 6h	7h 7h 7h	10h 10h 10h	2h 2h 2h		
16	4	11849	11424	11344	11425	11616		10	320
16	5	110054	11375	106	11219		11755	10	335
32	3	1113	1114	1115	11794	11426	11193	10	370
32	4	1116	1117	1118	1119	1120	1121	10	385
32	5	1122	1123	103	11023	11146	11124	10	390



103

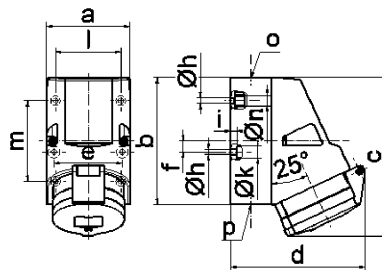

1 MB 2

Ampere	Poles	16	16	32	32	32
		4	5	3	4	5
a		83,0	83,0	83,0	83,0	83,0
b		126,0	126,0	126,0	126,0	126,0
c		153,0	155,0	155,0	155,0	155,0
d		127,0	130,0	130,0	130,0	136,0
e		68,0	68,0	68,0	68,0	68,0
f		11,0	11,0	11,0	11,0	11,0
ø h		5,5	5,5	5,5	5,5	5,5
i		6,5	6,5	6,5	6,5	6,5
ø k		12,0	12,0	12,0	12,0	12,0
l		65,0	65,0	65,0	65,0	65,0
m		80,0	80,0	80,0	80,0	80,0
ø n		10,0	10,0	10,0	10,0	10,0
o		M25	M25	M25	M25	M25
p		2xM25	2xM25	2xM25	2xM25	2xM25
Cond. mm² min		1,5	1,5	2,5	2,5	2,5
Cond. mm² max		4	4	10	10	10

Panel Mounting Socket Outlet

- Screw terminals
- Flange 75 x 75 mm
- Protection degree IP44

Ampere	Poles	110V	230V	400V	500V	>50V	>50V	Quantity	Each
		50-60 Hz	50-60 Hz	50-60 Hz	50-60 Hz	100-300Hz	301-500Hz		
		3pol 4pol 5pol	3pol 4pol 5pol	3pol 4pol 5pol	3pol 4pol 5pol	3pol 4pol 5pol	3pol 4pol 5pol		
		4h 4h 4h	6h 9h 9h	9h 6h 6h	7h 7h 7h	10h 10h 10h	2h 2h 2h		
16	3	13000	13001	13002	13042	13216	13053	10	115
16	4	1322	1323	1324	1325	1326	1327	10	140
16	5	13003	13004	13005	13043	13034	13033	10	155
32	3	13006	13007	13008	13058	13076	13313	10	190
32	4	13009	13010	13011	13012	13013	13014	10	200
32	5	1331	1332	1333	13167	13173	13050	10	205



1333

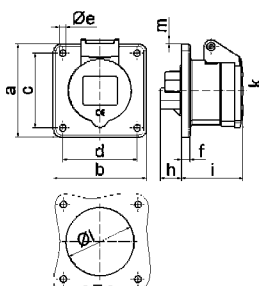

4 MB 4

Ampere	Poles	16	16	16	32	32	32
		3	4	5	3	4	5
a		75,0	75,0	75,0	75,0	75,0	75,0
b		75,0	75,0	75,0	75,0	75,0	75,0
c		60,0	60,0	60,0	60,0	60,0	60,0
d		60,0	60,0	60,0	60,0	60,0	60,0
ø e		5,5	5,5	5,5	5,5	5,5	5,5
f		7,0	7,0	7,0	8,0	8,0	8,0
h		17,0	26,0	17,0	36,0	36,0	19,0
i		51,0	53,0	53,0	62,0	62,0	62,0
k		70,0	80,0	85,0	90,0	90,0	98,0
ø l		45,0	45,0	55,0	60,0	60,0	60,0
m		3,5	7,0	11,5	12,0	12,0	17,0
Cond. mm² min		1,5	1,5	1,5	2,5	2,5	2,5
Cond. mm² max		4	4	4	10	10	10

Technical information

- IEC 60309-1/2, EN 60309, VDE 0623

Panel Mounting Socket Outlet

- Screw terminals
- 20° angled
- Flange 85 x 85 mm
- Protection degree IP44

3PHE Ampere	3PHE Poles	110V 50-60 Hz 3pol 4pol 5pol 4h 4h 4h	230V 50-60 Hz 3pol 4pol 5pol 6h 9h 9h	400V 50-60 Hz 3pol 4pol 5pol 9h 6h 6h	500V 50-60 Hz 3pol 4pol 5pol 7h 7h 7h	>50V 100-300Hz 3pol 4pol 5pol 10h 10h 10h	>50V 301-500Hz 3pol 4pol 5pol 2h 2h 2h	Quantity	Each
----------------	---------------	--	--	--	--	--	---	----------	------

16	3	12079	12080	12081	12485	12952	12483	10	125
16	4			12500		12520		10	150
16	5	12076	12077	12078	12491		12484	10	170
32	3	12324	12310					10	205
32	4		12325	12311	12368			10	210
32	5	1213	1214	1215	12369	12217		10	215



12078

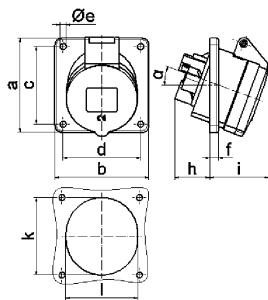

Ampere	16	16	16	32	32	32
Poles	3	4	5	3	4	5
a	85,0	85,0	85,0	85,0	85,0	85,0
b	85,0	85,0	85,0	85,0	85,0	85,0
c	70,0	70,0	70,0	70,0	70,0	70,0
d	70,0	70,0	70,0	70,0	70,0	70,0
ø e	5,5	5,5	5,5	5,5	5,5	5,5
f	8,0	8,0	8,0	8,0	8,0	8,0
h	30,0	30,0	30,0	50,0	50,0	34,0
i	48,0	50,0	54,0	63,0	63,0	60,0
k	57,0	65,0	70,0	78,0	78,0	78,0
l	57,0	65,0	70,0	78,0	78,0	78,0
α	20°	20°	20°	20°	20°	20°
Cond. mm² min	1,5	1,5	1,5	2,5	2,5	2,5
Cond. mm² max	4	4	4	10	10	10

4 MB 26

Panel Mounting Socket Outlet

- Screw terminals
- Flange 75 x 75 mm
- Protection degree IP67

3PHE Ampere	3PHE Poles	110V 50-60 Hz 3pol 4pol 5pol 4h 4h 4h	230V 50-60 Hz 3pol 4pol 5pol 6h 9h 9h	400V 50-60 Hz 3pol 4pol 5pol 9h 6h 6h	500V 50-60 Hz 3pol 4pol 5pol 7h 7h 7h	>50V 100-300Hz 3pol 4pol 5pol 10h 10h 10h	>50V 301-500Hz 3pol 4pol 5pol 2h 2h 2h	Quantity	Each
----------------	---------------	--	--	--	--	--	---	----------	------

16	3	1371	1372	1373		13265		10	140
16	4	1374	1375	1376	1377	1378	1379	10	165
16	5	1380	1381	1382	13044	13379	13380	10	185
32	3	13023	13024	13025		13264	13432	10	225
32	4	13026	13027	13028	13029	13030	13031	10	240
32	5	1368	1369	1370	13376	13377	13378	10	250



1370

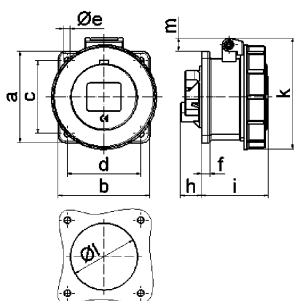

Ampere	16	16	16	32	32	32
Poles	3	4	5	3	4	5
a	75,0	75,0	75,0	75,0	75,0	75,0
b	75,0	75,0	75,0	75,0	75,0	75,0
c	60,0	60,0	60,0	60,0	60,0	60,0
d	60,0	60,0	60,0	60,0	60,0	60,0
ø e	5,5	5,5	5,5	5,5	5,5	5,5
f	7,0	7,0	7,0	8,0	8,0	8,0
h	17,0	26,0	17,0	36,0	36,0	19,0
i	57,0	58,0	57,0	65,0	65,0	65,0
k	76,0	83,0	93,0	100,0	100,0	106,0
ø l	45,0	45,0	55,0	60,0	60,0	60,0
m	3,5	7,0	11,5	12,0	12,0	17,0
Cond. mm² min	1,5	1,5	1,5	2,5	2,5	2,5
Cond. mm² max	4	4	4	10	10	10

4 MB 5

Panel Mounting Socket Outlet

- Screw terminals
- 20° angled
- Flange 85 x 85 mm
- Protection degree IP67

3PHE Ampere	3PHE Poles	110V 50-60 Hz 3pol 4pol 5pol 4h 4h 4h	230V 50-60 Hz 3pol 4pol 5pol 6h 9h 9h	400V 50-60 Hz 3pol 4pol 5pol 9h 6h 6h	500V 50-60 Hz 3pol 4pol 5pol 7h 7h 7h	>50V 100-300Hz 3pol 4pol 5pol 10h 10h 10h	>50V 301-500Hz 3pol 4pol 5pol 2h 2h 2h	Quantity	Each
----------------	---------------	--	--	--	--	--	---	----------	------

16	3		12231					10	160
16	4			12502				10	180
16	5	12082	12083	12084	12717			10	205
32	3	12326	12327					10	260
32	4		12328	12329	12614			10	270
32	5	1262	1263	1264				10	275



12084

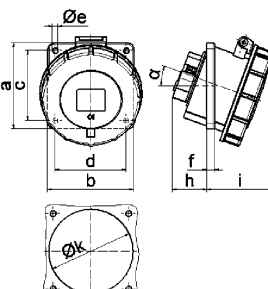

Ampere	16	16	16	32	32	32
Poles	3	4	5	3	4	5
a	85,0	85,0	85,0	85,0	85,0	85,0
b	85,0	85,0	85,0	85,0	85,0	85,0
c	70,0	70,0	70,0	70,0	70,0	70,0
d	70,0	70,0	70,0	70,0	70,0	70,0
ø e	5,5	5,5	5,5	5,5	5,5	5,5
f	8,0	8,0	8,0	8,0	8,0	8,0
h	30,0	30,0	30,0	50,0	50,0	34,0
i	55,0	57,0	59,0	67,0	67,0	69,0
k	57,0	65,0	70,0	78,0	78,0	78,0
l	57,0	65,0	70,0	78,0	78,0	78,0
α	20°	20°	20°	20°	20°	20°
Cond. mm² min	1,5	1,5	1,5	2,5	2,5	2,5
Cond. mm² max	4	4	4	10	10	10

4 MB 22

Plug with MULTI-GRIP

- Screw terminals
- One-piece enclosure
- Special gland, simultaneous cable gland and seal
- Protection degree IP44

MULTI-GRIP



204-TLS

	Ampere	Poles	110V 50-60 Hz	230V 50-60 Hz	400V 50-60 Hz	500V 50-60 Hz	>50V 100-300Hz	>50V 301-500Hz	Quantity	Each							
			3pol 4h	4pol 4h	5pol 4h	3pol 6h	4pol 9h	5pol 9h			3pol 9h	4pol 6h	5pol 6h	3pol 7h	4pol 7h	5pol 7h	3pol 10h
16	3		21000-TLS	21001-TLS	21002-TLS	21071-TLS			10	120							
16	4		21003-TLS	21004-TLS	21005-TLS	21006-TLS			10	130							
16	5		21009-TLS	21010-TLS	203-TLS	21037-TLS			10	150							
32	3		21012-TLS	21013-TLS	21014-TLS	21219-TLS			10	200							
32	4		21015-TLS	21016-TLS	21017-TLS	21018-TLS			10	220							
32	5		21021-TLS	21022-TLS	204-TLS	21011-TLS			10	250							

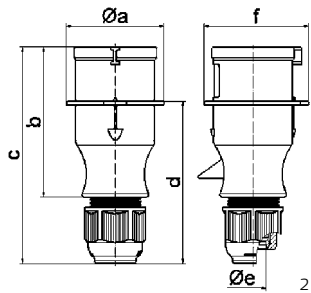

Ampere	16	16	16	32	32	32
Poles	3	4	5	3	4	5
Ø a	54,0	60,0	66,0	71,0	71,0	80,0
b	94,5	98,0	101,0	115,0	115,0	119,0
c	138,0	142,0	145,0	170,0	170,0	174,0
d	101,5	105,5	108,5	124,0	124,0	128,0
Ø e	18,0	18,0	18,0	23,0	23,0	23,0
f	56,6	64,0	71,0	76,0	76,0	85,0
Cond. mm² min	1	1	1	2,5	2,5	2,5
Cond. mm² max	2,5	2,5	2,5	6	6	6

2 MB 129

Plug with MULTI-GRIP

- Screw terminals
- Nickel plated contacts
- One-piece enclosure
- Special gland, simultaneous cable gland and seal
- Protection degree IP67

MULTI-GRIP



210589

	Ampere	Poles	110V 50-60 Hz	230V 50-60 Hz	400V 50-60 Hz	500V 50-60 Hz	>50V 100-300Hz	>50V 301-500Hz	Quantity	Each							
			3pol 4h	4pol 4h	5pol 4h	3pol 6h	4pol 9h	5pol 9h			3pol 9h	4pol 6h	5pol 6h	3pol 7h	4pol 7h	5pol 7h	3pol 10h
16	3		210575	210576	210577				10	155							
16	4		210581	210582	210583	210584			10	170							
16	5		210587	210588	210589				10	170							
32	3		210593	210594	210595				10	243							
32	4		210599	210600	210601				10	255							
32	5		210605	210606	210607				10	305							

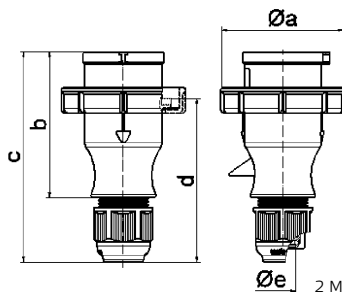

Ampere	16	16	16	32	32	32
Poles	3	4	5	3	4	5
Ø a	70,0	78,0	86,0	94,0	94,0	101,0
b	94,5	98,0	101,0	115,0	115,0	119,0
c	138,0	142,0	145,0	170,0	170,0	174,0
d	105,5	109,5	112,5	128,0	128,0	132,0
Ø e	18,0	18,0	18,0	23,0	23,0	23,0
Cond. mm² min	1	1	1	2,5	2,5	2,5
Cond. mm² max	2,5	2,5	2,5	6	6	6

2 MB 130

Connector with MULTI-GRIP

- Screw terminals
- One-piece enclosure
- Special gland, simultaneous cable gland and seal
- Protection degree IP44

MULTI-GRIP



304-TLS

Ampere	Poles	110V 50-60 Hz			230V 50-60 Hz			400V 50-60 Hz			500V 50-60 Hz			>50V 100-300Hz			>50V 301-500Hz			Quantity	Each
		3pol 4h	4pol 4h	5pol 4h	3pol 6h	4pol 9h	5pol 9h	3pol 9h	4pol 6h	5pol 6h	3pol 7h	4pol 7h	5pol 7h	3pol 10h	4pol 10h	5pol 10h	3pol 2h	4pol 2h	5pol 2h		
16	3	31000-TLS			31001-TLS			31002-TLS			31210-TLS			10	140						
16	4	31003-TLS			31004-TLS			31005-TLS			31006-TLS			10	160						
16	5	31009-TLS			31010-TLS			303-TLS			31031-TLS			10	180						
32	3	31012-TLS			31013-TLS			31014-TLS			31491-TLS			10	240						
32	4	31015-TLS			31016-TLS			31017-TLS			31018-TLS			10	250						
32	5	31021-TLS			31022-TLS			304-TLS			31023-TLS			10	260						

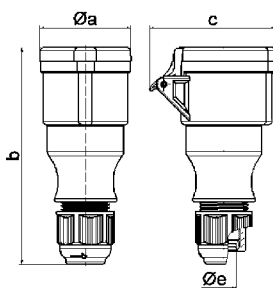

Ampere	16	16	16	32	32	32
Poles	3	4	5	3	4	5
Ø a	51,0	58,0	65,0	67,0	67,0	73,0
b	145,0	148,0	156,0	185,0	185,0	185,0
c	74,0	84,0	90,0	94,0	94,0	102,0
Ø e	18,0	18,0	18,0	23,0	23,0	23,0
Cond. mm² min	1	1	1	2,5	2,5	2,5
Cond. mm² max	2,5	2,5	2,5	6	6	6

3 MB 82

Connector with MULTI-GRIP

- Screw terminals
- Nickel plated contacts
- One-piece enclosure
- Special gland, simultaneous cable gland and seal
- Protection degree IP67

MULTI-GRIP



310346

Ampere	Poles	110V 50-60 Hz			230V 50-60 Hz			400V 50-60 Hz			500V 50-60 Hz			>50V 100-300Hz			>50V 301-500Hz			Quantity	Each
		3pol 4h	4pol 4h	5pol 4h	3pol 6h	4pol 9h	5pol 9h	3pol 9h	4pol 6h	5pol 6h	3pol 7h	4pol 7h	5pol 7h	3pol 10h	4pol 10h	5pol 10h	3pol 2h	4pol 2h	5pol 2h		
16	3	310331			310333			310334			10	175									
16	4	310338			310339			310340			10	200									
16	5	310344			310345			310346			10	220									
32	3	310350			310351			310352			10	305									
32	4	310356			310357			310358			10	315									
32	5	310362			310363			310364			10	360									

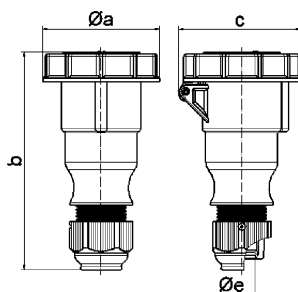

Ampere	16	16	16	32	32	32
Poles	3	4	5	3	4	5
Ø a	70,5	78,0	86,5	94,0	94,0	101,5
b	154,0	155,0	160,0	190,0	190,0	190,0
c	77,0	83,0	93,0	99,0	99,0	107,0
Ø e	18,0	18,0	18,0	23,0	23,0	23,0
Cond. mm² min	1	1	1	2,5	2,5	2,5
Cond. mm² max	2,5	2,5	2,5	6	6	6

3 MB 81

Distributor Enclosure

- Made of high-grade, impact-resistant plastic
- Cover screws made of plastic
- Metric cable entry on request

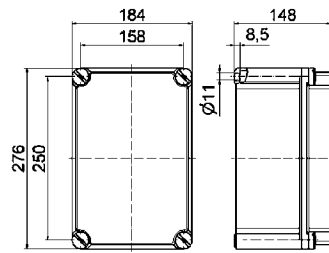

30 MB 121

Ref. no.

61133

Distributor Enclosure

- Made of high-grade, impact-resistant plastic
- Cover screws made of plastic
- Metric cable entry on request

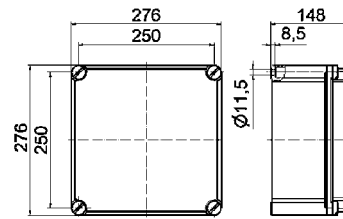

30 MB 122

Ref. no.

61134

Distributor Enclosure

- Made of high-grade, impact-resistant plastic
- With transparent hinged window
- 9 modules
- Cover screws made of plastic
- DIN rail
- Metric cable entry on request

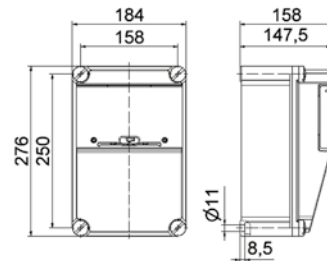

30 MB 145

Ref. no.

61402

Distributor Enclosure

- Made of high-grade, impact-resistant plastic
- Cover screws made of plastic
- Metric cable entry on request



6170

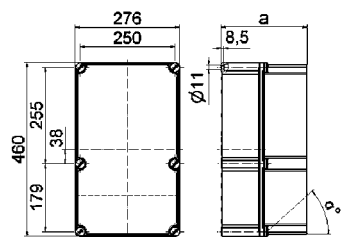

30 MB 98

a Ref. no.

0° 148,0 **6171**

0° 228,0 **6170**

25° 228,0 **6173**

42° 228,0 **6172**

30 MB 98

Distributor Enclosure

- Made of high-grade, impact-resistant plastic
- Cover screws made of plastic
- Metric cable entry on request



61101

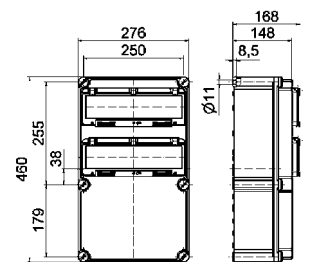

30 MB 137

Ref. no.

2 hinged windows **61101**

3 hinged windows **61128**

Hinged Window

- Self-closing
- With protection against accidental contact
- In the case of hinged windows for use with DIN screws (order No. 58036), add -GWE to the end of the order number

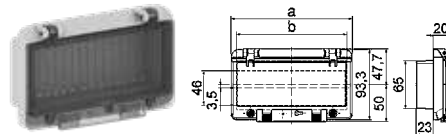

58009

30 MB 96

Module unit	Dimension a	Dimension b	Ref. no.
2	55,0	40,5	5881
4	91,0	76,5	5890
6	127,0	112,5	5899
8	162,0	147,5	58009
12	234,0	220,0	58018
13	257,5	248,5	58027

Hinged Window

- Self-closing
- Without protection against accidental contact
- In the case of hinged windows for use with DIN screws (order No. 58036), add -GWE to the end of the order number

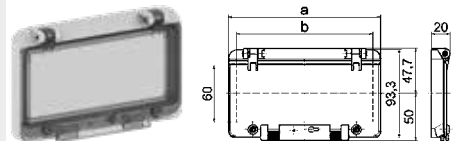

58010

30 MB 95

Module unit	Dimension a	Dimension b	Ref. no.
2	55,0	37,0	5882
4	91,0	73,0	5891
6	127,0	109,0	58001
8	162,0	144,5	58010
12	234,0	217,0	58019
13	257,5	240,0	58028

Hinged Window

- Self-closing
- With protection against accidental contact and mounting bracket
- In the case of hinged windows for use with DIN screws (order No. 58036), add -GWE to the end of the order number

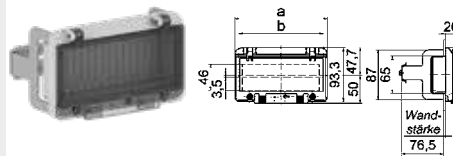

30 MB 97

Module unit	Dimension a	Dimension b	Ref. no.
2	55,0	40,5	5885
4	91,0	76,5	5894
6	127,0	112,5	58004
8	162,0	147,5	58013
12	234,0	220,0	58022
13	257,5	248,5	58031

Lock Set

- Protection against unauthorised use by means of retrofittable lock
- Can be installed in hinged window



Ref. no.

58037-BE

DIN Screws

- For additional locking device
- Retrofittable
- Can only be used in operating windows with order No.-GWE.



Ref. no.

58036

Ref. no.	Page/Pos.	Ref. no.	Page/Pos.	Ref. no.	Page/Pos.	Ref. no.	Page/Pos.
100	236/1	417	195/1	835	108/3 + 210/1	1164	39/2
101	236/1	418	195/1	837	108/3 + 210/1	1183	45/1
103	236/2	419	195/1	860	104/5	1184	45/1
106	236/2	420	196/1	1010	41/3	1185	45/1
107	41/2	421	196/1	1010-QC	41/1	1186	45/1
108	41/2	422	196/1	1011	41/4	1200	73/1
109	41/4	423	196/1	1012	41/2	1201	68/2
109-QC	41/1	424	196/1	1013	41/3	1202	68/2
119	228/1	425	196/1	1015	41/5	1203	73/1
129	73/1	426	196/1	1017	41/5	1204	68/2
134	65/3	427	196/1	1018	41/5	1205	73/1
136	65/3	428	196/1	1019	41/5	1206	73/1
140	75/3	429	196/1	1020	41/4	1207	68/2
141	75/3	430	195/2	1104	37/2	1208	68/2
142-BE	75/3	431	195/2	1106	37/2	1213	237/1
146	75/3	432	195/2	1107	37/2	1214	237/1
147	75/3	433	195/2	1108	37/2	1215	237/1
156	46/1	434	195/2	1112	39/2	1262	237/3
158	46/1	435	195/2	1113	236/2	1263	237/3
159	46/1	436	195/2	1114	236/2	1264	237/3
174	56/1	437	195/2	1115	236/2	1299	73/3
175	56/1	438	195/2	1116	236/2	1301	65/3
176	56/1	439	195/2	1117	236/2	1304	65/3
177	56/1	460	196/3	1118	236/2	1305	65/3
178	56/1	461	196/3	1119	236/2	1306	65/3
179	56/1	462	196/3	1120	236/2	1307	65/3
180	79/1	463	196/3	1121	236/2	1308	65/3
181	79/2	464	196/3	1122	236/2	1309	65/3
182	78/3	465	196/3	1123	236/2	1322	236/3
183-BE	78/4	466	196/3	1124	37/2	1323	236/3
187	78/2	467	196/3	1125	37/2	1324	236/3
188	78/2	468	196/3	1126	37/2	1325	236/3
189	78/2	469	196/3	1127	37/2	1326	236/3
203-TLS	238/1	526	168/1	1128	37/2	1327	236/3
204-TLS	238/1	530	164/1	1129	37/2	1331	236/3
219	229/2	546	173/1	1130	37/2	1332	236/3
224	102/1	591	143/1	1132	38/2	1333	236/3
225	102/1	592	143/1	1133	38/2	1368	237/2
227	102/1	712	118/1	1134	38/2	1369	237/2
231	86/3 + 229/1	713	118/1	1135	38/2	1370	237/2
235	86/3	714	118/1 + 225/3	1136	38/2	1371	237/2
236	86/3	724	121/1	1137	38/2	1372	237/2
240	87/1 + 229/4	726	121/1	1138	38/2	1373	237/2
242	89/1 + 230/1	735	219/4	1139	38/2	1374	237/2
245	87/3	736	121/5	1140	38/2	1375	237/2
249	87/3	737	121/5	1141	38/2	1376	237/2
251	228/4	745	220/1	1142	38/2	1377	237/2
254	228/5	746	123/1	1143	38/2	1378	237/2
255	228/5	747	123/1	1144	38/2	1379	237/2
258	228/5	749	123/2	1145	38/2	1380	237/2
260	95/1	753	219/5	1146	38/2	1381	237/2
261	95/1	754	122/1	1147	38/2	1382	237/2
262	95/1	755	122/1	1148	38/2	1395	70/1
263	95/1	770	120/2	1149	38/2	1396	70/1
264	95/1	772	120/4	1150	38/2	1397	70/1
265	95/1	776	120/3	1151	38/2	1398	70/1
266	95/1	779	120/1	1152	38/2	1399	70/1
267	95/1	812	231/3	1153	38/2	1500	46/1
268	95/1	813	231/3	1154	38/2	1501	46/2
303-TLS	239/1	814	231/3	1155	38/2	1502	46/2
304-TLS	239/1	815	231/3	1156	39/2	1503	46/2
410	195/1	816	231/3	1157	39/2	1504	46/1
411	195/1	817	231/3	1158	39/2	1505	46/1
412	195/1	830	108/3 + 210/1	1159	39/2	1506	46/1
413	195/1	831	108/3 + 210/1	1160	39/2	1507	46/2
414	195/1	832	108/3 + 210/1	1161	39/2	1508	46/2
415	195/1	833	108/3 + 210/1	1162	39/2	1509	46/2
416	195/1	834	108/3 + 210/1	1163	39/2	1529	46/1

Ref. no.	Page/Pos.	Ref. no.	Page/Pos.	Ref. no.	Page/Pos.	Ref. no.	Page/Pos.
1530	46/1	1850	78/1	2232	104/3	2614	96/1
1531	46/2	1851	78/1	2233	104/3	2615	96/1
1532	46/2	1852	78/2	2234	104/2	2616	96/1
1533	46/1	1854	78/2	2235	104/2	2617	96/1
1534	46/1	1862	79/4	2236	104/2	2618	96/1
1535	46/2	1863	79/4	2251	102/3	2619	96/1
1536	46/2	1864	79/4	2252	102/3	2620	96/1
1537	47/1	1865	79/4	2266	102/3	2621	96/1
1565	48/1	1866	79/4	2267	102/3	2622	96/1
1580	52/1	1896	79/4	2271	102/2	2623	96/1
1582	47/1	2104	84/3	2286	102/2	2624	96/1
1583	47/1	2125	84/1	2287	102/2	2625	95/2
1584	47/1	2126	84/1 + 229/3	2288	102/2	2626	95/2
1585	47/1	2129	84/1	2298	211/1	2627	95/2
1586	47/1	2130	84/1	2300-BE	86/3	2628	95/2
1587	47/1	2135	84/1	2311	203/3	2629	95/2
1588	47/1	2136	84/1	2316	203/3	2630	95/2
1589	47/1	2137	84/1	2318	203/3	2631	95/2
1594	47/1	2138	84/1	2319	203/3	2632	95/2
1595	47/1	2141	84/1	2320	203/3	2633	95/2
1596	47/1	2142	84/1	2321	203/3	2634	95/2
1597	47/1	2147	84/1	2322	203/3	2635	95/2
1598	50/1	2148	84/1	2323	203/3	2636	95/2
1599	50/1	2149	84/3	2324	203/3	2637	96/2
1610	53/1	2150	84/3	2400	89/2 + 230/2	2638	96/2
1611	53/1	2151	84/3	2402	91/1	2639	96/2
1616	53/1	2152	84/3	2415	87/3	2640	96/2
1619	53/1	2153	84/3	2448	87/1	2641	96/2
1641	53/1	2154	84/3	2461	89/3	2642	96/2
1642	53/1	2155	84/3	2465	89/3	2643	96/2
1674	44/5	2180	85/3	2469	90/1	2644	96/2
1675	44/5	2181	85/3	2470	90/1	2645	96/2
1676	44/5	2182	85/3	2471	90/1	2646	96/2
1734	56/1	2183	85/3	2472	91/1	2647	96/2
1735	56/1	2184	85/3	2473	91/1	2648	96/2
1736	56/1	2185	85/3	2474	91/1	2649	95/1
1770	57/1	2186	85/3	2475	91/1	2650	96/1
1771	57/1	2187	85/3	2476	91/1	2652	102/5
1773	57/1	2188	85/3	2477	91/1	2655	95/2
1775	56/1	2189	85/3	2478	91/1	2656	95/2
1776	56/1	2190	86/1	2479	91/1	2657	95/2
1777	56/1	2191	86/1	2480	91/1	2658	95/2
1778	56/1	2192	86/1	2481	91/1	2659	96/2
1779	57/1	2193	86/1	2482	91/1	2660	96/2
1780	57/1	2194	86/1	2483	91/1	2661	96/2
1781	57/1	2195	86/1	2484	91/2	2662	95/1
1782	57/1	2196	86/1	2485	91/2	2663	95/1
1783	56/1	2197	86/1	2486	91/2	2664	95/1
1784	56/1	2198	86/1	2487	91/2	2665	96/1
1785	56/1	2199	86/1	2488	91/2	2666	96/1
1786	56/1	2213	104/1	2489	91/2	2667	96/1
1787	57/1	2214	104/1	2490	91/2	2671	95/2
1788	57/1	2215	104/1	2491	91/2	2674	103/1
1789	57/1	2216	104/1	2492	91/2	2679	95/1
1790	57/1	2217	104/1	2493	91/2	2684	95/1
1791	57/1	2218	104/1	2494	91/2	2685	95/2
1792	57/1	2219	104/1	2495	91/2	2694	96/1
1793	56/1	2220	104/1	2600	95/1	2702	216/1
1794	56/1	2221	104/1	2601	96/1	2703	216/1
1795	57/1	2222	104/1	2602	102/5	2704	216/2
1796	57/1	2223	104/1	2603	102/5	2735	98/3
1797	58/1	2224	104/1	2604	96/2	2736	98/3 + 101/5
1798	58/1	2225	104/1	2607	103/4	2737	98/3 + 101/5
1799	58/1	2226	104/1	2608	103/4	2738	98/3
1843	78/1	2227	104/1	2610	95/1	2739	98/3 + 101/5
1847	78/1	2229	104/3	2611	95/1	2740	98/3 + 101/5
1848	78/1	2230	104/3	2612	95/1	2741	101/5
1849	78/1	2231	104/3	2613	96/1	2742	98/3



Ref. no.	Page/Pos.	Ref. no.	Page/Pos.	Ref. no.	Page/Pos.	Ref. no.	Page/Pos.
2743	98/3 + 101/5	3180	106/3	4231	196/2	4441	197/1
2744	98/3 + 101/5	3181	106/3	4232	196/2	4442	197/1
2745	216/1	3182	106/3	4233	196/2	4443	197/1
2770	97/2	3183	106/3	4234	196/2	4481	197/1
2771	97/2 + 101/2	3184	106/3	4235	196/2	4522	197/2
2772	97/2 + 101/2	3185	106/3	4236	196/2	4523	197/2
2773	97/2	3186	106/3	4237	196/2	4524	197/2
2774	97/2 + 101/2	3187	106/3	4238	196/2	4525	197/2
2775	97/2 + 101/2	3188	106/3	4239	196/2	4526	197/2
2776	101/2	3190	107/1	4240	196/2	4527	197/2
2779	97/2	3191	107/1	4241	196/2	4528	197/2
2780	97/2 + 101/2	3192	107/1	4242	196/2	4529	197/2
2781	97/2 + 101/2	3193	107/1	4243	196/2	4530	197/2
2783	98/1 + 101/3	3194	107/1	4274	196/1	4531	197/2
2786	98/1 + 101/3	3195	107/1	4310	195/2	4532	197/2
2787	98/1 + 101/3	3196	107/1	4311	195/2	4533	197/2
2793	98/1 + 101/3	3197	107/1	4312	195/2	4534	197/2
2833	99/3	3198	107/1	4313	195/2	4535	197/2
2834	99/3	3199	107/1	4314	195/2	4536	197/2
2835	100/2	3208	107/3	4315	195/2	4537	197/2
2836	100/2	3209	107/3	4316	195/2	4538	197/2
2837	99/3	3210	107/3	4317	195/2	4539	197/2
2838	100/2	3211	107/3	4318	195/2	4540	197/2
2841	99/3	3212	107/3	4319	195/2	4541	197/2
2842	100/2	3213	107/3	4320	195/2	4542	197/2
2853	217/2	3214	107/3	4321	195/2	4543	197/2
2857	103/3	3215	107/3	4354	195/3	4610	196/3
2858	99/3	3216	107/3	4355	195/3	4611	196/3
2860	100/3	3217	107/3	4356	195/3	4612	196/3
2861	100/3	3218	107/3	4357	195/3	4613	196/3
2864	99/3	3219	107/3	4358	195/3	4614	196/3
2869	99/3	3220	107/3	4359	195/3	4615	196/3
2870	103/3	3221	107/3	4360	195/3	4616	196/3
2876	100/3	4107	195/1	4361	195/3	4617	196/3
2880	99/3	4110	195/1	4362	195/3	4618	196/3
2881	100/2	4111	195/1	4363	195/3	4619	196/3
2882	100/3	4112	195/1	4364	195/3	4620	196/3
2892	217/1	4113	195/1	4365	195/3	4621	196/3
2893	217/1	4114	195/1	4366	195/3	5225	167/3
2894	217/1	4115	195/1	4367	195/3	5226	166/1
2895	217/1	4116	195/1	4368	195/3	5310	163/1
2896	217/1	4117	195/1	4369	195/3	5311	164/2
2897	217/1	4118	195/1	4370	195/3	5321	164/4
2898	99/2	4119	195/1	4371	195/3	5350	164/2
2899	100/1	4120	195/1	4372	195/3	5881	241/1
3104	105/3	4121	195/1	4373	195/3	5882	241/2
3108	105/3	4157	195/1	4374	195/3	5885	241/3
3109	105/3	4210	196/1	4375	195/3	5890	241/1
3112	105/3	4211	196/1	4390	195/2	5891	241/2
3124	106/3	4212	196/1	4422	197/1	5894	241/3
3125	105/1	4213	196/1	4423	197/1	5899	241/1
3126	105/1 + 230/3	4214	196/1	4424	197/1	6170	240/4
3129	105/1	4215	196/1	4425	197/1	6171	240/4
3130	105/1	4216	196/1	4426	197/1	6172	240/4
3135	105/1	4217	196/1	4427	197/1	6173	240/4
3136	105/1	4218	196/1	4428	197/1	7108	219/1
3137	105/1	4219	196/1	4429	197/1	7112	118/4
3138	105/1	4220	196/1	4430	197/1	7114	219/2
3141	105/1	4221	196/1	4431	197/1	7115	219/3
3142	105/1	4222	196/2	4432	197/1	7119	118/4
3147	105/1	4223	196/2	4433	197/1	7153	119/3
3148	105/1	4224	196/2	4434	197/1	7154	118/5
3149	105/3	4225	196/2	4435	197/1	7163	119/4
3150	105/3	4226	196/2	4436	197/1	7168	118/5
3151	105/3	4227	196/2	4437	197/1	7185	219/1
3152	105/3	4228	196/2	4438	197/1	7186	219/3
3153	105/3	4229	196/2	4439	197/1	7245	121/2
3154	105/3	4230	196/2	4440	197/1	7246	121/2

Ref. no.	Page/Pos.	Ref. no.	Page/Pos.	Ref. no.	Page/Pos.	Ref. no.	Page/Pos.
7370	121/4 + 230/5	11032	198/1	11555	39/1	11914	36/1
7371	121/4 + 230/5	11038	44/3	11556	210/4	11918	36/1
7372	121/4 + 226/1 + 230/5	11051	37/2	11566	38/3	11919	36/1
7373	230/5	11052	44/3	11579	38/3	11921	36/1
7400	220/2	11124	236/2	11580	39/1	11922	36/1
7416	123/1	11126	39/2	11616	236/2	11924	36/1
7423	220/2	11146	236/2	11630	38/3	11926	36/1
7424	220/1	11155	38/3	11634	189/2	11927	36/1
7432	123/2	11156	39/1	11635	189/3	11928	36/2
7455	123/1	11190-BE	45/1	11640	37/2	11930	36/2
7486	122/2 + 231/1	11193	236/2	11645	236/1	11931	36/2
7487	122/2 + 231/1	11208	37/2	11646	236/1	11932	36/2
7488	122/2 + 226/2 + 231/1	11219	236/2	11651	236/1	11933	36/2
7489	122/2 + 231/1	11221	37/2	11652	236/1	11934	36/2
7490	122/4 + 231/2	11320	38/2	11653	236/1	11944	36/3
7491	122/4 + 231/2	11326	38/2	11714	189/3	11945	36/3
7492	122/4 + 231/2	11334	200/2	11722	236/1	11947	36/3
7493	122/4 + 231/2	11341	39/2	11723	236/1	11948	36/3
8156	123/3	11342	38/2	11724	236/1	11949	36/3
8158	123/3	11343	38/2	11725	236/1	11955	36/3
8178	231/3	11344	236/2	11726	236/1	11956	36/3
8189	123/3	11345	37/2	11735	236/1	11957	36/3
8190	123/3	11350	38/2	11736	236/1	11960	36/3
8191	123/3	11368	39/2	11737	236/1	11962	36/3
8192	123/3	11375	236/2	11738	236/1	11963	36/3
8198	123/4	11389	45/1	11739	236/1	11968	42/1
8199	123/4	11390	38/2	11748	39/2	11972	42/1
8309	221/5	11424	236/2	11755	236/2	11973	42/1
8310	221/5	11425	236/2	11765	236/1	11977	42/1
8311	221/5	11426	236/2	11785	44/1	11978	42/1
8312	221/5	11429	37/2	11786	44/1	11979	42/1
8313	221/5	11432	38/2	11787	44/1	11983	42/1
8314	221/4	11433	39/2	11790	43/1	11984	42/1
8315	221/4	11436	39/3	11794	236/2	11985	42/1
8316	221/4	11437	39/3	11795	37/2	11989	42/1
8317	221/4	11438	39/3	11796	42/2	11990	42/1
8318	221/4	11439	39/3	11797	42/2	11991	42/1
8319	221/1	11440	39/3	11798	42/2	11995	42/3
8320	221/1	11441	39/3	11799	42/2	11997	42/4
8324	221/5	11442	39/3	11800	42/5	11998	42/4
8325	221/5	11443	39/3	11801	42/5	11999	42/4
8326	221/4	11444	39/3	11802	42/5	12000	73/1
8327	221/4	11445	39/3	11803	42/5	12001	73/1
8328	221/3	11446	39/3	11812	43/5	12002	73/1
8329	221/3	11447	39/3	11813	43/5	12003	73/1
8330	221/3	11448	42/3	11814	43/5	12004	73/1
8331	221/3	11449	42/3	11815	43/5	12020	75/1
8332	221/3	11451	42/3	11822	43/3	12025	75/1
8333	221/3	11452	43/1	11823	43/3	12032	72/2
8334	221/3	11453	43/1	11824	43/3	12034	201/1
8335	221/2	11455	43/1	11825	43/3	12035	73/1
8336	221/2	11461	39/1	11826	43/4	12039	73/1
8337	221/2	11476	40/2	11827	43/4	12052	75/1
8338	221/2	11477	40/2	11828	43/4	12053	75/1
8339	221/2	11478	40/2	11829	43/4	12054	75/1
8340	221/2	11479	40/2	11832	236/1	12055	73/3
8341	221/2	11480	188/1	11836	236/1	12065	201/1
8614	104/4 + 230/4	11481	188/1	11849	236/2	12074	68/1
8615	104/4 + 230/4	11482	188/1	11879	39/1	12076	237/1
8618	104/4	11483	188/1	11889	192/2	12077	237/1
11014	44/3	11485	42/1	11895	36/1	12078	237/1
11017	39/2	11487	42/1	11897	236/1	12079	237/1
11019	200/2	11492	38/3	11905	36/1	12080	237/1
11023	236/2	11493	38/3	11906	36/2	12081	237/1
11025	38/2	11496	39/1	11907	36/2	12082	237/3
11027	38/2	11538	42/1	11909	36/3	12083	237/3
		11542	189/2	11910	36/1	12084	237/3
		11554	45/1	11912	36/1	12085	214/1

Ref. no.	Page/Pos.	Ref. no.	Page/Pos.	Ref. no.	Page/Pos.	Ref. no.	Page/Pos.
12086	214/1	12392	188/3	12752	67/1	12821	71/3
12087	214/1	12393	188/3	12753	67/1	12822	71/3
12088	214/2	12394	189/5	12754	67/1	12823	71/3
12100	73/3 + 77/5	12395	189/5	12755	67/1	12824	71/3
12101	73/3 + 77/5	12396	189/5	12756	67/1	12825	72/1
12102	73/3	12397	189/5	12757	67/1	12826	72/1
12103	73/3 + 77/5	12398	76/3	12758	67/1	12831	72/1
12104	73/3 + 77/5	12401	76/3	12759	67/1	12832	72/1
12105	73/3 + 77/5	12405	76/4	12760	67/1	12833	72/1
12106	73/3	12406	76/4	12761	67/1	12834	72/1
12107	73/3 + 77/5	12407	76/4	12762	67/1	12835	72/1
12108	73/3 + 77/5	12408	76/4	12763	67/1	12836	72/1
12133	73/3 + 77/5	12409	77/4	12764	67/1	12837	72/1
12134	68/2	12410	77/4	12765	67/1	12838	72/1
12135	68/2	12483	237/1	12766	67/1	12839	72/1
12136	68/2	12484	237/1	12767	67/1	12840	72/1
12137	68/2	12485	237/1	12768	67/1	12841	72/1
12138	68/2	12491	237/1	12769	67/1	12842	72/1
12139	75/1	12500	237/1	12770	67/1	12843	72/1
12144	198/3	12502	237/3	12771	67/2	12844	72/1
12153	68/2	12511	74/3	12772	67/2 + 228/3	12846	72/1
12156	77/4	12520	237/1	12773	67/2	12847	72/1
12160	77/4	12555	74/2	12774	67/2	12848	72/1
12169	214/1	12563	68/1	12775	67/2	12849	72/1
12171	73/1	12565	68/1	12776	67/2	12850	72/1
12191	214/2	12566	68/1	12777	67/2	12851	72/1
12195	68/2	12567	68/1	12778	67/2	12852	72/1
12205	77/3	12568	68/1	12779	67/2	12853	72/1
12217	237/1	12569	72/2	12780	67/2	12854	72/1
12230	68/2	12570	72/2	12781	67/2	12855	72/1
12231	237/3	12571	72/2	12782	67/2	12856	72/1
12233	73/1	12572	72/2	12783	67/2	12857	72/1
12235	214/1	12573	72/2	12784	67/2	12861	67/1
12236	214/1	12574	72/2	12785	67/2	12862	67/1
12237	214/1	12596	74/2	12786	67/2	12863	67/1
12238	214/1	12614	237/3	12787	67/2	12864	67/1
12239	214/2	12616	74/3	12788	67/2	12865	67/1
12240	214/2	12646	74/2	12789	67/2	12866	67/1
12241	214/2	12648	74/2	12790	67/2	12867	67/1
12242	214/1	12649	74/2	12791	67/2	12868	67/1
12251	201/1	12650	74/2	12792	67/2	12869	67/1
12264	214/2	12651	74/2	12793	67/2	12870	67/1
12275	201/1	12652	74/2	12794	67/2	12871	67/1
12278	73/3	12653	74/2	12795	67/2	12872	67/1
12280	214/1	12689	193/1	12796	67/2	12873	67/1
12310	237/1	12699	214/1	12797	67/2	12874	67/2
12311	237/1	12700	214/1	12798	67/2	12876	76/3
12320	73/3	12717	237/3	12799	67/2	12877	76/3
12324	237/1	12730	67/2	12800	67/2	12878	76/3
12325	237/1	12731	66/2	12801	67/2	12880	76/3
12326	237/3	12732	66/2	12802	67/2	12882	76/3
12327	237/3	12733	66/2	12803	67/2	12883	76/3
12328	237/3	12734	66/2	12804	67/2	12884	76/3
12329	237/3	12735	66/2	12805	67/3	12917	71/3
12334	73/3	12736	66/2	12806	67/3	12919	77/3
12340	214/1	12739	66/2	12808	71/2	12920	77/3
12341	214/2	12740	66/2	12809	71/2	12921	77/3
12342	214/2	12741	66/2	12810	71/2	12922	77/3
12343	214/2	12742	66/2	12811	71/2	12924	77/3
12360	74/3	12743	66/3	12812	71/2	12925	77/3
12368	237/1	12744	66/3	12813	71/3	12926	77/3
12369	237/1	12745	66/3	12814	71/3	12927	77/3
12381	68/2	12746	66/3	12815	71/3	12928	77/3
12382	68/2	12747	66/3	12816	71/3	12929	71/3
12383	68/2	12748	67/1	12817	71/3	12930	71/3
12389	73/1	12749	67/1	12818	71/3	12931	71/3
12390	188/3	12750	67/1	12819	71/3	12952	237/1
12391	188/3	12751	67/1	12820	71/3	12953	214/2

Ref. no.	Page/Pos.	Ref. no.	Page/Pos.	Ref. no.	Page/Pos.	Ref. no.	Page/Pos.
12954	214/2	13183	213/1	13667	65/1	13739	69/2
12955	214/2	13184	213/1	13668	65/1	13740	69/2
12990	228/2	13186	213/2	13669	65/1	13741	69/2
13000	236/3	13187	213/2	13670	65/1	13742	69/2
13001	236/3	13188	213/2	13671	65/1	13743	69/2
13002	236/3	13189	213/1	13672	65/1	13744	69/2
13003	236/3	13216	236/3	13673	65/1	13745	69/2
13004	236/3	13254	65/3	13674	65/1	13746	69/2
13005	236/3	13264	237/2	13675	65/1	13747	69/2
13006	236/3	13265	237/2	13676	65/1	13748	69/2
13007	236/3	13297	213/1	13677	65/1	13749	69/2
13008	236/3	13298	213/2	13678	65/1	13750	69/2
13009	236/3	13313	236/3	13679	65/1	13751	69/2
13010	236/3	13320	65/3	13680	65/1	13752	69/2
13011	236/3	13321	65/3	13681	65/1	13753	69/2
13012	236/3	13326	188/2	13682	65/1	13754	69/2
13013	236/3	13327	188/2	13683	65/1	13755	69/2
13014	236/3	13328	188/2	13684	65/1	13756	69/2
13023	237/2	13329	188/2	13685	64/1	13757	69/2
13024	237/2	13330	189/4	13686	64/1	13758	69/2
13025	237/2	13331	189/4	13687	64/1	13759	69/2
13026	237/2	13332	189/4	13688	64/1	13760	69/2
13027	237/2	13333	189/4	13689	64/1	13761	69/2
13028	237/2	13334	76/1	13690	64/1	13762	69/2
13029	237/2	13336	76/1	13691	64/1	13764	69/2
13030	237/2	13341	76/2	13692	64/1	13765	69/2
13031	237/2	13342	76/2	13693	64/1	13771	76/1
13032	213/1	13343	76/2	13694	64/1	13773	76/1
13033	236/3	13344	76/2	13695	64/1	13774	76/1
13034	236/3	13376	237/2	13696	64/1	13775	76/1
13042	236/3	13377	237/2	13697	64/1	13776	76/1
13043	236/3	13378	237/2	13698	64/1	13777	76/1
13044	237/2	13379	237/2	13699	64/1	13810	77/1
13048	75/2	13380	237/2	13700	64/1	13812	77/1
13050	236/3	13382	77/2	13701	64/1	13813	77/1
13051	65/3	13383	77/2	13702	64/1	13814	77/1
13053	236/3	13384	77/2	13703	64/1	13815	77/1
13058	236/3	13385	77/2	13704	64/1	13816	77/1
13064	213/1	13432	237/2	13705	64/1	13822	192/3
13065	213/1	13434	71/1	13706	64/1	13835	64/2
13066	213/1	13435	71/1	13707	64/1	13839	213/2
13067	213/2	13436	71/1	13708	64/1	13840	213/2
13070	198/2	13442	71/1	13709	64/1	13841	213/2
13075	200/4	13445	70/3	13710	64/1	13849	200/4
13076	236/3	13447	70/3	13711	64/1	13850	64/2
13077	65/3	13448	70/3	13712	64/1	13851	64/2
13098	213/1	13449	70/3	13713	64/1	13895	65/2
13100	70/1	13451	70/3	13714	64/1	13896	65/2
13101	70/1	13452	70/3	13715	64/1	13915	213/2
13102	70/1	13476	76/1	13716	64/1	13916	213/2
13103	70/1	13515	71/1	13717	64/1	13918	213/2
13104	70/1	13592	65/3	13718	64/1	13919	213/2
13105	75/2	13613	192/4	13719	69/1	13920	213/2
13106	75/2	13633	213/1	13720	69/1	13921	213/2
13107	75/2	13634	213/1	13721	69/1	13923	213/2
13108	75/2	13646	64/3	13724	69/1	13924	213/2
13140	65/3	13647	213/2	13725	69/1	13925	213/2
13144	76/1	13656	64/3	13726	69/1	13926	213/2
13146-BE	75/2	13657	64/3	13727	69/1	13927	213/2
13156	77/1	13658	64/3	13730	69/1	13928	213/1
13157	77/1	13659	64/3	13731	69/1	13929	213/1
13159	77/1	13660	64/3	13732	69/1	13930	213/1
13166	213/1	13661	64/3	13733	69/2	13932	213/1
13167	236/3	13662	64/3	13734	69/2	13933	213/1
13168	65/3	13663	64/3	13735	69/2	13935	213/1
13173	236/3	13664	64/3	13736	69/2	15000	50/1
13175	213/1	13665	64/3	13737	69/2	15001	50/1
13182	213/1	13666	64/3	13738	69/2	15006	52/2

Ref. no.	Page/Pos.	Ref. no.	Page/Pos.	Ref. no.	Page/Pos.	Ref. no.	Page/Pos.
15007	52/2	15138	49/1	16104	54/2	17037	56/1
15008	52/2	15139	49/1	16123	53/2	17038	57/1
15009	52/2	15140	49/1	16124	54/2	17039	58/1
15013	50/1	15141	49/1	16125	54/3	17040	58/1
15017	49/1	15142	50/1	16138	54/1	17041	59/1
15019	46/1	15143	50/1	16374	190/3	17042	59/1
15024	46/2	15144	50/1	16378	190/4	17044	58/1
15027	48/1	15145	50/1	16380	190/5	17045	58/1
15028	48/1	15146	49/1	16441	190/3	17046	59/1
15029	47/1	15147	49/1	16445	190/4	17047	59/1
15030	47/1	15148	49/1	16447	190/5	17055	56/1
15035	49/1	15149	50/1	16449	199/3	17056	56/1
15036	49/1	15150	50/1	16450	199/4	17057	56/1
15038	51/1	15151	50/1	16602	54/3	17058	56/1
15042	52/2	15152	51/1	16603	53/3	17059	56/1
15043	52/2	15153	51/1	16604	54/3	17060	56/1
15044	47/1	15154	51/1	16605	53/3	17061	57/1
15045	47/1	15155	51/1	16606	54/3	17062	57/1
15047	52/1	15156	51/1	16620	55/1	17063	57/1
15052	49/1	15157	52/1	16621	55/1	17064	57/1
15058	49/1	15158	52/1	16622	55/1	17065	57/1
15059	46/1	15159	52/1	16721	53/3	17066	57/1
15072	52/1	15160	52/1	16827	53/3	17087	58/1
15075	52/1	15161	51/1	16828	54/3	17107	58/1
15076	47/1	15162	51/1	16831	55/1	17134	58/1
15077	47/1	15163	51/1	16871	44/2	17162	57/1
15078	48/1	15164	51/1	16872	44/2	17163	58/1
15079	48/1	15165	52/1	16873	44/2	17164	58/1
15080	50/1	15166	52/1	16875	54/2	17165	58/1
15081	49/1	15167	52/1	16886	61/4	17166	58/1
15082	49/1	15168	52/1	16890	61/5	17167	58/1
15083	50/1	15169	52/1	16901	60/4	17168	58/1
15095	46/1	15170	52/1	16906	60/1	17169	58/1
15096	46/1	15171	52/1	16907	60/1	17170	58/1
15097	46/2	15172	49/1	16915	61/1	17175	59/1
15098	46/2	15174	50/1	16916	61/1	17176	59/1
15099	46/2	15175	50/1	16930	55/1	17177	59/1
15100	46/2	15176	48/1	16933	53/3	17178	59/1
15101	46/1	15177	48/1	16934	54/3	17179	59/1
15102	46/1	15239	46/1	16956	53/3	17180	59/1
15103	46/1	15240	46/2	17000	58/1	17181	59/1
15104	46/1	15352	48/1	17001	59/1	17182	59/1
15105	46/1	15382	46/1	17002	59/1	17186	58/1
15106	46/2	15383	46/2	17003	59/1	17187	58/1
15107	46/2	15384	46/1	17004	59/1	17188	58/1
15108	46/2	15385	46/2	17007	58/1	17189	58/1
15109	46/2	15386	46/1	17008	58/1	17192	59/1
15110	46/2	15387	46/2	17009	58/1	17193	59/1
15111	48/1	15388	48/1	17010	58/1	17194	59/1
15112	48/1	16008	53/1	17011	59/1	17195	59/1
15113	48/1	16038	53/2	17012	59/1	17213	59/1
15114	48/1	16039	53/2	17013	59/1	17216	59/1
15115	48/1	16040	54/2	17014	59/1	17233	56/1
15116	48/1	16041	54/2	17019	58/1	17234	56/1
15121	48/1	16042	53/2	17020	58/1	17238	57/1
15122	48/1	16043	53/2	17021	59/1	17275	56/1
15123	48/1	16050	209/1	17022	59/1	17276	56/1
15124	48/1	16058	53/2	17026	210/5	17277	56/1
15125	47/1	16059	54/2	17027	56/1	17278	57/1
15126	47/1	16060	53/2	17028	56/1	17279	57/1
15127	48/1	16064	53/2	17029	57/1	17280	56/1
15128	48/1	16065	54/2	17030	57/1	17281	56/1
15129	49/1	16066	53/2	17031	57/1	17282	56/1
15130	49/1	16070	44/4	17032	56/1	17283	56/1
15131	49/1	16071	44/4	17033	56/1	17284	56/1
15132	49/1	16072	44/4	17034	57/1	17285	56/1
15133	50/1	16093	53/3	17035	57/1	17286	56/1
15134	50/1	16097	53/2	17036	57/1	17287	56/1

Ref. no.	Page/Pos.	Ref. no.	Page/Pos.	Ref. no.	Page/Pos.	Ref. no.	Page/Pos.
17288	56/1	17535	58/1	21006-TLS	238/1	21428	215/2
17289	57/1	17536	58/1	21009-TLS	238/1	21429	215/2
17290	57/1	17537	58/1	21010-TLS	238/1	21430	215/2
17291	57/1	17538	59/1	21011-TLS	238/1	21431	215/2
17292	57/1	17539	59/1	21012-TLS	238/1	21432	215/2
17293	57/1	17540	59/1	21013-TLS	238/1	21433	215/2
17294	57/1	17541	59/1	21014-TLS	238/1	21453	85/1
17295	57/1	17542	59/1	21015-TLS	238/1	21461	201/3
17296	57/1	17543	59/1	21016-TLS	238/1	21484	85/1
17297	57/1	17544	59/1	21017-TLS	238/1	21486	85/1
17298	56/1	17545	59/1	21018-TLS	238/1	21487	85/1
17299	56/1	17546	59/1	21021-TLS	238/1	21515	201/3
17300	56/1	17547	59/1	21022-TLS	238/1	21526	84/3
17301	56/1	17548	59/1	21024	84/3	21531	84/3
17302	56/1	17549	59/1	21025	84/3	21533	85/1
17303	56/1	17550	59/1	21033	215/2	21545	85/1
17304	56/1	17551	59/1	21037-TLS	238/1	21555	86/1
17305	56/1	17552	59/1	21059	201/3	21557	188/4
17306	56/1	17553	59/1	21060	85/3	21558	85/1
17307	57/1	17554	59/1	21063	201/3	21564	85/1
17308	57/1	17555	58/1	21071-TLS	238/1	21607	86/1
17309	57/1	17556	58/1	21154	85/3	21623	84/2
17310	57/1	17557	58/1	21155	86/1	21624	84/3
17311	57/1	17558	58/1	21156	86/1	21645	85/3
17312	57/1	17559	59/1	21163	85/3	21663	84/3
17313	57/1	17560	59/1	21167	84/3	21667	190/1
17314	57/1	17561	59/1	21208	215/1	21669	190/1
17315	57/1	17562	59/1	21209	215/1	21686	84/2
17316	58/1	17566	62/1	21210	215/2	21687	84/2
17317	58/1	17569	62/1	21219-TLS	238/1	21688	84/2
17319	59/1	17573	62/1	21220	215/1	21689	84/2
17320	59/1	17576	62/1	21221	215/1	21690	84/2
17322	58/1	17579	62/1	21232-TLQ	209/4	21691	84/2
17323	58/1	17583	63/1	21237	85/1	21692	84/2
17324	58/1	17586	63/1	21238	85/1	21693	84/2
17325	58/1	17590	63/1	21239	85/1	21706	199/1
17328	59/1	17593	63/1	21240	85/1	21711	190/1
17329	59/1	17596	63/1	21241	85/1	21712	190/1
17330	59/1	17604	63/1	21250	85/1	21754	85/1
17331	59/1	17608	62/1	21251	85/1	21785	193/3
17334	57/1	17612	62/1	21282	85/1	21837	84/2
17335	56/1	17615	62/1	21300	84/3	21838	84/2
17336	57/1	17618	62/1	21330	85/3	21839	84/2
17337	56/1	17622	62/1	21349	85/1	21840	84/2
17338	56/1	17626	62/1	21350	85/1	21841	84/2
17339	56/1	17629	62/1	21351	85/1	21842	84/2
17340	57/1	17632	62/1	21352	85/1	21843	84/2
17341	57/1	17635	62/1	21375	85/3	21844	84/2
17342	57/1	17638	62/1	21380	215/1	21847	84/2
17343	58/1	17642	63/1	21402	85/1	21848	84/2
17344	58/1	17646	63/1	21403	85/1	21849	84/2
17345	59/1	17649	63/1	21404	85/1	21850	84/2
17346	59/1	17652	63/1	21405	85/1	21851	86/1
17387	59/1	17656	63/1	21406	85/1	21868	198/4
17521	58/1	17660	63/1	21407	85/1	21869	198/5
17522	58/1	17663	63/1	21408	85/1	21872	84/2
17523	58/1	17666	63/1	21409	85/1	21873	84/2
17524	58/1	17669	63/1	21410	85/1	21876	198/5
17525	58/1	17672	63/1	21411	85/1	21879	84/2
17526	58/1	17847	56/1	21412	85/1	21882	198/4
17527	58/1	18048	79/3	21413	85/1	21885	84/2
17528	58/1	18049	79/3	21414	85/1	21907	193/2
17529	58/1	21000-TLS	238/1	21419	84/3	21966	193/3
17530	58/1	21001-TLS	238/1	21423	215/1	22052	102/1
17531	58/1	21002-TLS	238/1	21424	215/1	22053	102/1
17532	58/1	21003-TLS	238/1	21425	215/1	22054	102/1
17533	58/1	21004-TLS	238/1	21426	215/1	22055	102/1
17534	58/1	21005-TLS	238/1	21427	215/1	24012	90/1

Ref. no.	Page/Pos.	Ref. no.	Page/Pos.	Ref. no.	Page/Pos.	Ref. no.	Page/Pos.
24013	91/2	24410	88/1	27102	216/2	27299	216/2
24017	90/1	24411	88/1	27104	216/1	27300	216/2
24018	90/1	24412	88/1	27105	216/1	27301	216/2
24019	90/1	24413	88/1	27106	216/1	27302	216/2
24020	91/1	24414	90/2	27107	216/1	27303	216/2
24021	91/1	24415	90/2	27108	216/1	27304	216/2
24022	91/1	24416	91/3	27109	216/2	27305	216/2
24023	91/2	24418	91/3	27110	216/2	28000	217/2
24024	91/2	24419	92/1	27117	191/3	28001	99/1
24025	91/2	24422	87/2	27118	191/3	28002	99/1
24035	92/2	24423	87/2 + 229/5	27119	191/3	28003	99/1
24062	92/2	24539	87/2	27120	191/3	28004	99/1
24078	91/2	24540	87/2	27121	97/1 + 101/1	28005	99/1
24079	91/1	24543	201/5	27122	97/1 + 101/1	28006	99/1
24089	91/2	24551	88/1	27124	97/1 + 101/1	28008	99/1
24101	91/1	24594	193/5	27201	216/1	28009	99/1
24114	91/1	24625	193/4	27204	216/1	28010	99/1
24134	88/2	24626	193/4	27207	97/1 + 101/1	28011	99/1
24140	92/2	24627	193/4	27209	97/1	28012	99/1
24145	92/2	24628	201/4	27210	97/1 + 101/1	28013	99/1
24154	91/1	24629	201/4	27211	97/1	28014	99/1
24193	188/5	24630	201/4	27212	101/1	28015	99/1
24194	188/5	24631	201/5	27215	97/1	28017	99/1
24195	188/5	24632	201/5	27216	97/1 + 101/1	28042	217/2
24196	188/5	26001	191/1	27217	101/1	28043	217/2
24197	92/3	26002	191/1	27218	97/1	28044	217/2
24198	92/3	26003	191/2	27219	97/1 + 101/1	28045	217/2
24199	92/3	26004	191/2	27220	97/1 + 101/1	28100	99/2
24200	92/3	26005	191/2	27221	97/1	28101	100/1
24201	92/3	26006	191/2	27222	97/1 + 101/1	28102	99/2
24202	92/3	26008	102/5	27223	97/1 + 101/1	28103	100/1
24208	102/4	26009	103/4	27224	101/1	28104	99/2
24209	102/4	26010	103/4	27227	98/1	28105	100/1
24210	102/4	26012	191/1	27228	98/1 + 101/3	28106	99/2
24211	102/4	26013	191/1	27229	98/1	28107	100/1
24216	91/2	26015	95/2	27230	101/3	28108	99/2
24220	92/3	26020	103/1	27233	98/1	28109	100/1
24221	92/3	26023	95/1	27234	98/1 + 101/3	28111	99/1
24222	92/3	26026	95/1	27235	98/1	28112	99/1
24232	92/2	26028	95/1	27236	98/1 + 101/3	28181	103/2
24241	193/5	26029	95/1	27237	98/1 + 101/3	28182	103/5
24250	201/5	26030	95/1	27238	98/1	28183	103/2
24258	92/1	26033	96/1	27239	98/1 + 101/3	28184	103/5
24279	92/3	26036	95/1	27240	98/1 + 101/3	28298	224/3
24320	92/2	26050	93/1	27241	101/3	28312	224/3
24335	90/1	26051	93/1	27244	98/1	28313	224/3
24336	88/2	26052	93/2	27245	98/1 + 101/3	28314	224/3
24337	88/2	26053	93/2	27246	98/1 + 101/3	28315	224/3
24338	88/2	26054	94/1	27247	97/1	28316	224/3
24339	88/2	26055	94/1	27248	97/1 + 101/1	29129	108/4 + 197/3
24340	92/2	26056	94/2	27249	97/1 + 101/1	29132	108/2
24341	92/2	26057	94/2	27267	216/2	29133	108/2
24342	92/2	26065	95/1	27268	216/2	29148	108/2
24362	88/1	27006	98/2	27269	216/2	29149	108/2
24392	87/2	27007	98/2 + 101/4	27270	216/2	29150	108/2
24393	87/2	27008	98/2 + 101/4	27278	101/3	29151	225/2
24398	87/2	27009	98/2	27286	216/1	29152	225/2
24399	87/2	27010	98/2 + 101/4	27287	216/1	29153	225/2
24400	87/2	27011	98/2 + 101/4	27288	216/1	29154	225/2
24401	87/2	27012	101/4	27289	216/1	29951	225/2
24402	87/2	27015	98/2	27291	216/1	31000-TLS	239/1
24403	87/2	27016	98/2 + 101/4	27292	216/1	31001-TLS	239/1
24404	87/2	27017	98/2 + 101/4	27293	216/1	31002-TLS	239/1
24405	87/2	27024	101/5	27294	216/1	31003-TLS	239/1
24406	87/2	27027	209/5	27295	216/2	31004-TLS	239/1
24407	87/2	27043	216/1	27296	216/2	31005-TLS	239/1
24408	88/1	27045	216/2	27297	216/2	31006-TLS	239/1
24409	88/1	27046	216/1	27298	216/2	31009-TLS	239/1

Ref. no.	Page/Pos.	Ref. no.	Page/Pos.	Ref. no.	Page/Pos.	Ref. no.	Page/Pos.
31010-TLS	239/1	31500	105/3	53290	163/3	71028	119/3
31012-TLS	239/1	31501	106/2	53420	163/3	71031	219/2
31013-TLS	239/1	31504	106/3	53525	163/2	71071	120/1
31014-TLS	239/1	31505	106/3	53679	165/2	71094	118/2
31015-TLS	239/1	31512	190/2	53681	165/1	71095	118/2
31016-TLS	239/1	31513	190/2	53909	165/1	71097	118/2 + 225/4
31017-TLS	239/1	31514	190/2	54566	172/3	71099	118/2
31018-TLS	239/1	31515	190/2	54567	173/1	71100	118/2
31021-TLS	239/1	31533	105/2	54568	172/2	71101	118/2 + 225/4
31022-TLS	239/1	31534	105/2	54569	172/3	71104	225/5
31023-TLS	239/1	31536	105/2	54580	173/4	71105	118/3
31027	218/2	31605	106/3	54655	172/1	71106	118/3
31031-TLS	239/1	31606	105/3	54657	172/1	71107	118/3
31032	218/1	31611	107/1	54740	173/2	71108	118/3
31045	202/2	31627	194/2	54741	173/3	71109	118/3
31082	106/3	31641	194/2	54801	173/4	71110	118/3
31085	105/3	31642	105/3	54880	172/2	71118	119/1
31086	105/3	31659	105/2	54929	173/2	71119	119/1
31150	218/1	31661	105/2	57074	175/3	71120	119/1
31151	218/1	31662	105/2	57076	174/1	71121	119/2
31152	218/2	31664	105/2	57078	174/2	71122	119/2
31162	218/1	31665	105/2	57092	174/1	71123	119/2
31183	106/3	31666	105/2	57116	174/3	71142	119/5
31186-TLQ	210/3	31669	105/2	57117	174/2	76100	121/3
31207	106/2	31670	105/2	57119	174/3	81000	123/4
31210-TLS	239/1	31671	105/2	57143	162/3	81001	123/4
31240	106/2	31672	105/2	57148	162/1	81002	123/4
31241	106/2	31677	199/2	57250	175/2	81003	123/4
31242	106/2	31681	105/2	57255	162/3	85000	156/1
31243	106/2	31716	202/2	57360	176/4	85002	156/2
31244	106/2	31719	202/2	57623	162/2	85005	157/2
31245	106/2	31723	105/3	57829	175/2	85006	156/1
31246	106/2	31724	106/3	57996	162/2	85007	156/2
31247	106/2	31752	189/1	58001	241/2	85008	156/3
31251	106/3	31779	194/1	58004	241/3	85009	157/1
31257	105/3	31858	105/3	58009	241/1	85016	157/1
31266	202/2	31865	218/1	58010	241/2	85034	157/2
31298	106/2	31866	218/1	58013	241/3	85036	156/3
31299	106/2	31877	218/2	58018	241/1	89000	130/3
31301	106/2	31884	105/2	58019	241/2	89002	130/2
31302	106/2	31955	105/2	58022	241/3	89003	130/1
31303	106/2	31956	105/2	58027	241/1	89004	130/2
31304	106/2	31957	105/2	58028	241/2	89006	130/1 + 231/4
31305	106/2	31959	105/2	58031	241/3	89010	131/3
31306	106/2	31962	105/2	58036	241/5	89013	132/1
31307	106/2	31964	105/2	58037-BE	181/3 + 241/4	89015	132/1
31308	106/2	31965	105/2	58058	78/5	89016	131/1
31309	106/2	31966	105/2	58110	220/3	89017	132/2
31310	106/2	31967	105/2	58111	220/3	89022	132/3
31311	106/2	31968	105/2	58370	180/4	89028	132/2
31312	106/2	31970	105/2	58387	220/3	89037	131/2
31313	106/2	31971	105/2	58388	220/3	89038	132/3
31314	106/2	31972	105/2	58400	108/1	89040	131/2
31318	218/1	31973	105/2	58401	108/1	89044	131/3
31319	218/1	31974	105/2	58402	108/1	89048	132/4
31320	218/1	31975	105/2	58502	220/4	89070	133/3
31321	218/1	31976	105/2	58503	220/4	89075	133/2
31322	218/1	31979	105/2	58511	220/4	89076	133/3
31323	218/1	31981	105/2	58517	220/5	89084	133/1
31324	218/2	31983	105/2	58590	220/3	89085	133/1
31325	218/2	31984	105/2	58602	220/4	89086	133/2
31326	218/2	43003	195/3	58607	220/4	89094	134/2
31327	218/2	45044	197/2	61101	240/5	89095	134/3
31328	218/2	52480	168/3	61128	240/5	89099	134/2
31329	218/2	52638	168/2	61133	240/1	89101	134/3
31417	107/1	53141	163/2	61134	240/2	89107	134/1
31457	106/2	53213	164/3	61402	240/3	89119	135/2
31491-TLS	239/1	53247	164/3	71001	119/4	89120	135/2



Ref. no.	Page/Pos.	Ref. no.	Page/Pos.	Ref. no.	Page/Pos.	Ref. no.	Page/Pos.
89122	135/1	110561	38/1	120583	74/1	160474	203/2
89123	135/3	110562	38/1	120584	74/1	160576	203/1
89127	135/1	110563	38/1	120585	74/1	210030	84/3
89128	136/1	110564	38/1	120586	74/1	210067	188/4
89129	136/1	110565	38/1	120587	74/1	210077	215/1
89134	136/2	110566	38/1	120588	74/1	210078	215/1
89142	135/3	110567	38/1	120589	74/1	210169	84/2
89146	134/1	110568	38/1	120590	74/1	210170	84/2
89148	136/3	110569	38/1	120591	74/1	210171	84/2
89987	136/3	110570	38/1	120592	74/1	210176	84/2
110000	42/4	110571	38/1	121317	74/2	210178	84/2
110014	43/2	110572	38/1	122001	66/3	210179	84/2
110015	43/2	110573	38/1	130040	192/3	210184	84/2
110016	43/2	110574	38/1	130055	200/4	210185	84/2
110017	43/2	110575	38/1	130077	192/3	210186	84/2
110018	42/3	110576	38/1	130111	76/1	210193	84/2
110019	42/4	110577	192/1	130114	66/1	210197	84/2
110020	43/1	110578	192/1	130119	70/2	210222	85/1
110054	236/2	110579	192/1	130130	66/1	210234	85/1
110073	36/3	110580	200/1	130131	70/2	210238	193/2
110075	39/1	110581	200/1	130153	66/1	210256	215/2
110094	38/3	110583	200/2	130154	70/2	210263	215/2
110098	42/4	112001	36/1	130156	209/2	210264	215/2
110129	236/1	112002	36/1	130158	69/3	210265	215/2
110130	236/1	120025	214/1	130196	223/3	210358	193/2
110140	192/2	120026	214/1	130232	200/4	210402	193/2
110322	36/3	120027	214/1	130269	223/1	210403	215/1
110328	200/2	120029	214/1	130270	223/1	210404	215/1
110353	192/1	120030	214/1	130271	223/1	210405	215/1
110383	37/2	120031	214/1	130272	223/1	210406	215/1
110387	43/1	120032	214/1	130273	223/1	210408	215/1
110388	43/1	120034	214/2	130274	223/1	210409	215/1
110394	192/1	120035	214/2	130275	223/2	210410	215/1
110413	39/2	120036	214/2	130276	223/2	210411	215/1
110415	37/2	120037	214/2	130277	192/3	210413	215/2
110416	39/2	120039	214/2	130278	192/3	210414	215/2
110435	38/3	120041	214/2	130279	192/4	210415	215/2
110436	38/3	120042	214/2	130280	200/3	210417	215/2
110445	37/2	120043	214/2	130281	200/3	210419	215/2
110446	39/2	120150	192/5	130282	200/3	210421	215/2
110451	36/3	120157	192/5	130283	200/3	210422	215/2
110452	39/3	120158	77/3	130315	223/3	210423	215/2
110468	39/3	120159	77/3	132001	64/1	210550	188/4
110481	200/1	120161	77/3	132002	64/1	210575	85/2 + 238/2
110486	37/3	120162	77/3	160048	54/1	210576	85/2 + 238/2
110487	37/3	120256	192/5	160049	54/1	210577	85/2 + 238/2
110488	40/1	120274	72/3	160052	54/1	210581	85/2 + 238/2
110489	40/1	120275	200/5	160053	54/1	210582	85/2 + 238/2
110541	37/1	120277	200/5	160055	54/1	210583	85/2 + 238/2
110542	37/1	120280	193/1	160056	54/1	210584	238/2
110543	37/1	120282	192/5	160057	54/1	210587	85/2 + 238/2
110544	37/1	120306	68/3	160058	54/1	210588	85/2 + 238/2
110545	37/1	120307	73/2	160087	190/5	210589	85/2 + 238/2
110546	37/1	120320	72/3	160177	54/2	210593	85/2 + 238/2
110547	37/1	120321	68/3	160178	54/2	210594	85/2 + 238/2
110548	37/1	120322	73/2	160179	54/2	210595	85/2 + 238/2
110549	37/1	120336	200/5	160180	60/2	210599	85/2 + 238/2
110550	37/1	120342	72/3	160181	60/3	210600	85/2 + 238/2
110551	37/1	120368	200/5	160182	61/2	210601	85/2 + 238/2
110552	37/1	120387	73/2	160184	61/3	210605	85/2 + 238/2
110553	37/1	120431	68/3	160290	54/3	210606	85/2 + 238/2
110554	37/1	120436	223/4	160438	190/4	210607	85/2 + 238/2
110555	37/1	120437	223/4	160467	203/1	210628	201/2
110556	37/1	120438	223/4	160468	203/1	210636	188/4
110557	37/1	120439	223/4	160470	203/1	210668	193/2
110558	37/1	120440	223/4	160471	203/2	210710	224/2
110559	38/1	120441	223/4	160472	203/2	210711	224/2
110560	38/1	120442	192/5	160473	203/2	210735	224/1

Ref. no.	Page/Pos.	Ref. no.	Page/Pos.	Ref. no.	Page/Pos.	Ref. no.	Page/Pos.
210747	223/5	310351	106/1 + 239/2	560509	153/1	580659	181/2
210761	84/3	310352	106/1 + 239/2	560965	153/1	580721	181/4
210762	85/3	310356	106/1 + 239/2	560967	151/1	580727	181/3
210763	84/3	310357	106/1 + 239/2	561090	177/1	580860	180/1
210764	85/3	310358	106/1 + 239/2	561449	152/2	581219	183/1
210765	84/3	310362	106/1 + 239/2	561844	153/2	581273	181/1
210766	85/3	310363	106/1 + 239/2	561872	154/1	581276	141/1
210778	201/2	310364	106/1 + 239/2	562306	152/2	581323	180/4
210779	201/2	310381	189/1	562366	178/2	581324	180/4
210788	223/5	310415	106/2	562372	177/1	581325	180/4
210791	223/5	310417	106/2	562373	151/2	581433	183/1
210792	224/1	310426	210/2	562374	152/1	748609	122/3
210824	209/4	310441	202/1	562376	154/2	748709	122/3
210916	223/5	310465	225/1	562377	152/1	748809	122/3
210950	86/2	310466	225/1	562378	154/1	748909	122/3
210951	86/2	310488	224/5	562379	153/2	749009	122/5
210962	201/2	310489	224/4	562380	154/2	749109	122/5
211018	203/4	310490	105/3	562389	177/2	749209	122/5
211019	203/4	310491	106/3	562390	177/2	749309	122/5
211020	203/4	310492	105/3	562391	178/1	890011	132/4
211021	203/4	310493	106/3	562392	178/1	890083	136/2
211022	203/4	310494	105/3	562393	178/2	890400	131/1
211023	203/4	310495	106/3	570451	176/2	890919	137/1
211024	203/4	310507	202/1	570531	175/4	890920	137/1
211025	203/4	310508	202/1	571121	175/1	890921	137/2
211026	203/4	310512	224/4	571276	175/4	890922	137/2
211102	224/1	310513	224/4	571370	176/4	890923	137/3
211103	223/5	310515	224/4	572185	171/3	890924	137/3
211104	223/5	310517	224/4	572238	176/2	890925	138/1
211127	224/2	310518	224/5	572301	176/1	890926	138/1
242001	87/2	310519	194/1	572551	171/2	890927	138/2
242002	87/2	310554	106/2	572567	171/1	890928	138/2
282001	99/1	310564	194/1	573072	171/2	890929	138/3
282002	99/1	310567	210/3	573143	176/1	890930	138/3
310044	194/1	310607	224/4	573151	176/3	890931	138/4
310058	218/2	310628	202/1	573395	175/1	890932	138/4
310059	218/2	310634	107/2	574339	171/1	890933	139/1
310060	218/2	310635	107/2	574421	171/3	890934	139/1
310068	194/1	310697	203/5	576086	162/1	890935	139/2
310123	189/1	310698	203/5	576277	175/3	890936	139/2
310163	218/1	310699	203/5	576282	176/3	890937	139/3
310165	218/1	310700	203/5	580020	220/4	890938	139/3
310167	218/1	310701	203/5	580137	220/5	890939	139/4
310168	218/1	310702	203/5	580138	220/3	890940	139/4
310169	218/1	310703	203/5	580141	220/5	893419	140/1
310171	218/1	310704	203/5	580143	220/5	895347	130/3 + 140/2
310172	218/1	310749	224/5	580144	220/5	896285	142/1
310174	218/2	310771	225/1	580145	220/5	896329	140/3
310175	218/2	521828	169/3	580508	179/3	896346	140/1
310176	218/2	522143	168/2	580511	180/2	896347	140/2
310177	218/2	522144	166/3	580521	180/2	896368	142/2
310179	218/2	522167	169/2	580529	180/2	896373	142/1
310180	218/2	522589	168/4	580589	179/2	896374	142/2
310182	218/2	522590	166/1	580634	78/5	896376	142/3
310183	218/2	523291	168/4	580640	181/3	896377	142/3
310194	218/1	524443	169/2	580641	181/4	896400	140/3
310311	189/1	524446	170/1	580642	108/5 + 181/3	896437	211/3
310318	203/5	524449	167/2	580643	181/4	896459	211/2
310331	106/1 + 239/2	530003	164/1	580647	181/1	896462	211/2
310333	106/1 + 239/2	530090	165/2	580648	181/1	896463	211/3
310334	106/1 + 239/2	530179	163/1	580649	181/1	2148509	209/3
310338	106/1 + 239/2	530321	164/4	580650	181/1	5200568	167/2
310339	106/1 + 239/2	530425	165/3	580651	181/1	5200917	167/4
310340	106/1 + 239/2	530426	165/3	580652	181/1	5201003	170/3
310344	106/1 + 239/2	540055	173/3	580653	181/1	5201004	167/3
310345	106/1 + 239/2	560030	179/1	580656	181/1	5201015	166/3
310346	106/1 + 239/2	560384	151/2	580657	181/2	5201047	166/2
310350	106/1 + 239/2	560508	151/1	580658	181/2	5201555	168/3

1
2
3
4
5
6
7
8

Ref. no.	Page/Pos.	Ref. no.	Page/Pos.	Ref. no.	Page/Pos.
5201558	166/2	50003218	141/3	5402044	182/3
5201926	167/1	51010578	55/2	5402046	183/1
5202236	167/1	890936	162/2	5402047	183/3
5202237	167/4	890937	162/3	5402049	185/1
5202238	168/1	890938	162/3	5402050	185/1
5202239	169/1	890939	162/4	5402051	185/2
5202240	169/1	891089	257/2	5402052	185/2
5202241	169/3	894639	143/4	5402053	185/3
5202242	170/1	894879	147/1	5402054	185/3
5202243	170/2	895347	139/3	5402059	183/4
5202244	170/3	896294	162/4	5402060	183/4
5202245	170/4	896337	148/1	5402159	184/1
5202469	170/2	896342	153/1	5402160	184/1
5202470	170/4	896401	140/3	5402161	184/2
5202999	161/1	896402	141/4	5402162	184/2
5203000	161/2	896403	145/4	5402163	184/3
5203001	161/3	896404	154/1	5402164	184/3
5401274	148/3	896437	227/3	5402165	184/4
5401302	148/1	896459	227/2	5402166	184/4
5401343	147/2	896462	227/2	5402794	181/3
5401453	148/2	896463	227/3	5402795	183/2
5401455	147/1	2148509	225/3	7109909	118/3
5401567	147/1	5101381	269/1	7110009	118/3
5401662	147/3	5101904	269/2	7110109	118/3
5401668	147/2	5200568	191/2	7110809	119/1
5401882	146/1	5200917	191/4	7110909	119/1
5401884	146/1	5201003	194/3	7111009	119/1
5401886	146/2	5201004	191/3	7111809	120/1
5401892	146/2	5201015	190/3	7111909	120/1
5401894	146/3	5201047	190/2	7112009	120/1
5402044	147/3	5201555	192/3	7112109	120/2
5402046	148/1	5201558	190/2	7112209	120/2
5402047	148/3	5201926	191/1	7112309	120/2
5402049	150/1	5202236	191/1	51001751	269/2
5402050	150/1	5202237	191/4	51010578	55/2
5402051	150/2	5202238	192/1		
5402052	150/2	5202239	193/1		
5402053	150/3	5202240	193/1		
5402054	150/3	5202241	193/3		
5402059	148/4	5202242	194/1		
5402060	148/4	5202243	194/2		
5402159	149/1	5202244	194/3		
5402160	149/1	5202245	194/4		
5402161	149/2	5202292	257/1		
5402162	149/2	5202293	257/1		
5402163	149/3	5202294	257/1		
5402164	149/3	5202295	257/1		
5402165	149/4	5202329	257/2		
5402166	149/4	5202330	257/2		
5402794	146/3	5202368	257/1		
5402795	148/2	5202469	194/2		
7111809	119/1	5202470	194/4		
7111909	119/1	5202999	261/1		
7112009	119/1	5203000	261/2		
7112109	119/2	5203001	261/3		
7112209	119/2	5401274	183/3		
7112309	119/2	5401302	183/1		
20001402	141/4	5401343	182/2		
33010594	79/4	5401453	183/2		
50002819	141/2	5401455	182/1		
50003186	141/2	5401567	182/1		
50003203	141/4	5401662	182/3		
50003205	141/3	5401668	182/2		
50003206	141/2	5401882	181/1		
50003208	141/2	5401884	181/1		
50003209	141/2	5401886	181/2		
50003210	141/2	5401892	181/2		
50003211	141/2	5401894	181/3		

1

2

3

4

5

6

7

8

1. Scope of applicability, master agreement, contract conclusion

- 1.1 The following Terms and Conditions shall apply exclusively for our deliveries and services to entrepreneurs (§ 14 of the German Civil Code (BGB)). Any purchasing terms and conditions to the contrary are not legally enforceable, even if we do not explicitly reject them. By placing an order and/or accepting the delivery thereof, the buyer acknowledges acceptance of our terms and conditions.
- 1.2 An order becomes binding for us once we have issued a written confirmation or upon having begun to fulfil the order. All agreements concluded between us and the ordering party for the purpose of performance of this contract are recorded in writing in this contract.
- 1.3 The following terms and conditions apply to existing business relationships as well as to future business dealings which do not specifically make reference to them.

2. Offers, cost estimates, prices and the reserved right to make price changes

- 2.1 Our offers, as well as the prices and delivery options stated in our catalogues, printed materials, letters, etc. are subject to change without notice; cost estimates are non-binding.
- 2.2 All orders shall only be accepted on the basis of prices valid at the time of order placement. Our prices are understood to be in euro (Incoterms® 2010), ex works, exclusive of the respective VAT, and excluding freight, customs duty, additional import fees, packaging and insurance, which may possibly have to be charged separately.
- 2.3 With respect to all orders – including call-off orders and multiple delivery contracts – for which the delivery, as provided for in the contract or at the request of the ordering party, takes place later than four months after order placement, we are authorised within the scope of the order and as compensation to pass along to the ordering party any material and labour price increases occurring between contract conclusion and actual delivery.
- 2.4 For new orders (including follow-up orders), we are not obligated to any previous prices.

3. Commercial and intellectual property rights

- 3.1 The sales documents made available by the selling party – such as drafts, drawings, advertising and video material – shall still remain property of the selling party even if proportional costs have been remunerated for this purpose by the buyer.
- 3.2 The selling party unrestrictedly reserves all of his commercial rights, intellectual property rights and exploitation rights to cost estimates, drawings and other documents (hereinafter referred to as: Documents). The documents may only be made accessible to third parties upon the prior consent of the selling party, and must be – in the event that the order is not issued to the selling party – promptly returned to the selling party at his request. Clauses 1 and 2 apply correspondingly to documents of the buyer; these may however be made accessible to those third parties whom the selling party has permissibly commissioned to carry out deliveries.

4. Shipping, costs, transfer of risk

- 4.1 The shipping shall take place on the account and risk of the buyer. We bear no liability – also not in the case of carriage paid delivery – for damage or losses incurred during transport. If nothing else has been agreed, we shall decide on the type of packaging and means of shipping.
- 4.2 If shipment is delayed due to circumstances for which we

bear no responsibility, then the transfer of risk shall take place on the day that the buyer has been notified of the readiness for shipment.

5. Packaging

- 5.1 Insofar as nothing to the contrary has been agreed, we shall select the packaging, mode of shipment and the shipping route.
- 5.2 If the goods have been billed according to weight, then the usage of packaging and wrapping material shall be calculated at a price according to the gross weight.
- 5.3 Special, not commercially customary packaging material shall be charged extra.
- 5.4 Upon the written request of the buyer, the goods shall be insured at his own expense against risks to be determined by him.

6. Delivery deadlines and liability provisions, acceptance obligation in case of blanket orders and call-off orders, return deliveries

- 6.1 The delivery period shall begin as soon as all delivery details have been clarified, both parties agree on all of the terms and conditions of the transaction and the ordering party has effected payment of an agreed instalment, if applicable. The delivery deadline has been complied with if, until it expires, either the delivery item has departed the plant or the ordering party has been notified as to its readiness for shipment.
- 6.2 The adherence to our delivery obligation within the agreed delivery deadline further presupposes the prompt, correct and complete fulfilment of all obligations on the part of the buyer. The right to objection of the non-fulfilment of contract remains reserved.
- 6.3 If our delivery does not take place in adherence to the deadline and also not within an extended deadline – which must consist of at least 20 workdays – set by the ordering party, due to reasons for which we bear responsibility, then the ordering party is entitled to void the ordered delivery.
- 6.4 In the event of subsequent order amendment, we are no longer bound to the originally assured and confirmed delivery deadline.
- 6.5 Subsequent order amendments, quantity changes and cancellations can only be accepted if they do not entail any costs for us; otherwise, we shall be compelled to charge the buyer for the costs.
- 6.6 In case of contracts with continuous delivery, the arrangement according to class and type must be communicated to us in due time. If call-offs of partial quantities are not communicated in due time, we shall be authorised to – after first having set an indisputable extended deadline – designate and deliver partial quantities ourselves, or alternatively to withdraw from the nonfulfilled portion of the contract as per the further prerequisites of Paragraph 6.8 and to require indemnification as restitution for the ensuing loss that we suffer. The right to enforcement of further damage claims as might possibly arise remains undiminished.

- 6.7 The regulation in Paragraph 11 shall apply for compensation claims due to delayed fulfilment or non-fulfilment in lieu of performance.
- 6.8 If force majeure or circumstances for which we cannot be held accountable (e.g. operational disruptions, strikes) hinder us in the punctual fulfilment of the order, we are then entitled in order to fulfil assumed obligations to reasonably postpone delivery or, if the hindrances consequently

make contract performance impossible, to withdraw from the contract in whole or in part. The same holds true if we have not received delivery of material at all, or with delay, from our suppliers which we have ordered from them and which is required for fulfilment of the order, due to reasons for which we cannot be held accountable. The prerequisite for a withdrawal is that we promptly inform the ordering party about the unavailability and, as the case may be, immediately refund any consideration provided by the ordering party. Claims for indemnification of any kind are hereby excluded.

- 6.9 Partial deliveries are permissible.

7. Quality guidelines for production and delivery

- 7.1 Tolerances:
As a rule, we apply quality assurance methods to our production, which as a minimum comply with ISO 9001 requirements. Production is carried out based on the respectively applicable testing and assessment guidelines, as well as the tolerances for weight, dimensional and quantity variations specified therein.

7.2 Production processes

The selling party thereby reserves the right to change the production processes insofar as the buying party has not required any restrictions or information obligation with regard to them.

8. Retention of title

- 8.1 We shall retain title to the delivery item (goods subject to retention of title) until all of our accounts receivable due from the ordering party from the business relationship, including any accounts receivable which might arise in the future – comprising those contracts concluded at the same time or at a later date, have been settled. In case of running accounts, the retained title and all rights apply as collateral for our entire current account balance claims, together with interest and costs. In the event of seizures or other intervention by third parties, the ordering party must immediately inform us.
- 8.2 The ordering party is authorised to process and resell the delivery item in the ordinary course of business. This authorisation shall end if the ordering party is in payment default, or additionally in case of the cessation of payments by the ordering party, or if the opening of insolvency proceedings has been filed against the assets of the ordering party (default / enforcement event). The ordering party is obliged to resell the item delivered under reservation of title only under the condition of title retention and to ensure that the accounts receivable derived from the resale are transferred to us as per 8.5. Also regarded as resale is if the goods subject to retention of title are used to fulfil works contracts and works-supply contracts. The ordering party is not entitled to any other dispositions regarding the goods subject to retention of title, particularly the pledging of goods or transfer of security. An assignment of accounts receivable from the transfer of our goods subject to retention of title is not permitted, unless it is a matter of an assignment within the course of true factoring, which must be shown to us and for which the value of the factoring proceeds exceeds the amount of our secured receivables. Our accounts receivable are due immediately once the factoring proceeds have been credited.
- 8.3 Pursuant to Art. 950 of the BGB, the ordering party does not acquire ownership of a new item through the treating and processing of the goods subject to retention of title. The processing or transformation is undertaken for us without obligating us. The treated and processed goods are regarded as goods subject to retention of title.
- 8.4 In the case of processing, combining and mixing of the goods subject to retention of title with other goods,

our claim entitlement to co-ownership of the new good amounts to the proportional invoice value of the goods subject to retention of title in comparison with the invoice value of the other goods used. If our property rights are rendered null and void through combining, mixing or processing, consequently the ordering party shall immediately transfer to us the property rights and expectancy rights pertaining to the new form of the item to which he is entitled proportionate to the invoice value of the goods subject to retention of title and, in the case of processing, proportionate to the invoice value of the goods subject to retention of title vis-à-vis the invoice value of the other goods used, and maintain custody of it for us free of charge. Our co-ownership rights are regarded as goods subject to retention of title.

8.5 The accounts receivable of the ordering party derived from the reselling of the goods subject to retention of title are to be assigned to us now by way of security. These serve as collateral in the same scope as the goods subject to retention of title. If the goods subject to retention of title are resold by the ordering party together with other goods, then the accounts receivable derived from the resale shall be assigned to us proportionate to the invoice value of the goods subject to retention of title vis-à-vis the invoice value of the other goods. In the event of a resale of the goods for which we hold co-ownership shares as per 8.4, a share of the accounts receivable shall be assigned to us corresponding to our coownership share. Other accounts receivable which take the place of the goods subject to retention of title or which otherwise arise with respect to the goods subject to retention of title - such as insurance claims and claims from a breach of duty or an unlawful act - shall also be assigned. The ordering party is irrevocably entitled to collect the accounts receivable assigned to us in his own name. We may revoke the direct debit mandate in the case of a default / enforcement event.

8.6 The ordering party authorises us to inform the customer of the assignment and to collect the accounts receivable as soon as the default / enforcement event occurs. We can require a review of the status of the assigned accounts receivable by our agents based on the bookkeeping of the ordering party. The ordering party must provide us with a list of the residual goods subject to retention of title and all information necessary for asserting the assigned accounts receivable, including a list of his accounts receivable from the resale of the goods subject to retention of title with the name and address of the customer.

8.7 If the value of the existing collateral exceeds the total secured receivables by more than 10%, then at the request of the ordering party we are obligated to release collateral to that extent, at our discretion and in observance of the interests of the ordering party. The collateral value is regarded as the invoice value for simple and subsequent retention of title at which the ordering party procures the goods from us, and for extended retention of title the invoice value at which the ordering party resells our goods, each with a valuation discount of one third of the subscription price or the nominal value of the assigned accounts receivable.

8.8 In the event of cheques or other means of payment, payment is only then regarded as having been made after secured posting of the sum by the ordering party. We shall only accept cheques on account of performance. Payments that have been made against the transfer of a cheque or another means of payment are only then considered as having been remitted once a reversal to us is precluded. Notwithstanding our extended collateral rights, the collateral ceded to us up to this point in time continues to exist.

8.9 Based on the retention of title, we can require the possession of the delivery item if we have withdrawn from the contract. We are authorised to withdraw without taking

into account any of the further prerequisites of Art. 323 of the BGB, in particular without having to set a deadline, from that point in time at which the ordering party has defaulted on payment in whole or in part. The same holds true if the ordering party has ceased payment or if the opening of insolvency proceedings has been filed against the assets of the ordering party. All costs arising from the repossession of the delivery item shall be borne by the ordering party. We are authorised to freely dispose of the reclaimed delivery item.

9. Notification of defects, claims for defects, liability provision

9.1 Notwithstanding the continued duty of inspection, notification, and rejection due in a mutual commercial transaction, the ordering party is obligated to inspect the delivered goods for apparent flaws and report to us in writing any complaints with respect to such apparent flaws - this also applies to incomplete or incorrect deliveries - within one week after having received the goods; and, furthermore, with respect to flaws which only later become apparent, within one week after they have been detected by the ordering party. Otherwise, the goods shall be regarded as having been accepted, also with regard to apparent flaws, and the ordering party can thus not derive any rights therefrom with respect to us. This does not apply to a direct sale to a private consumer. In the event of legitimate notification of defects, we are obligated to rectification of the flaw of the delivered goods free of charge or, at our discretion, replacement delivery. If the rectification or replacement delivery fail despite two attempts, or if we unjustifiably refuse these or cause unconscionable delay, then the ordering party is entitled to abatement of the remuneration or, if construction work is not object of the liability for defects, to require rescission of the contract at his discretion.

9.2 Claims for damages due material defects are governed by the following in Paragraph 11.

9.3 Claims for defects are unwarranted if the flaw is traceable back to a violation of the operating, maintenance or installation specifications, unsuitable or improper use, incorrect or negligent handling by the ordering party and natural wear and tear, as well as due to intervention undertaken in the delivery item by the ordering party or third parties.

10. Terms and conditions of payment and consequences in case of noncompliance, offsetting

10.1 Insofar as nothing to the contrary has been agreed, our accounts receivable are to be paid free of postage and other charges within 30 days after having received our invoice or an equivalent statement of accounts receivable, at the latest however 30 days after the due date and receipt of the consideration provided. For payments remitted thereafter we shall charge interest at an annual rate of 8%.

10.2 In case of drafts and cheques, payment is only then regarded as having been remitted after the sum has been posted. Discounts and charges shall be borne by the ordering party.

10.3 We shall only accept drafts and cheques on account of performance, and drafts only upon special agreement. Independent of the term period of accepted drafts or a granted forbearance, our accounts receivable are due immediately if the ordering party does not adhere to the terms and conditions of payment or circumstances that could cast doubt on his creditworthiness become known. Furthermore, in a case such as this we are authorised to only carry out deliveries against payment in advance or the provision of collateral, or to withdraw from the contract after a reasonable extended deadline, and/or to require indemnification.

10.4 Only counterclaims that are undisputed or have been

legally determined to be valid can be offset by the ordering party vis-à-vis our accounts receivable. A right of retention is excluded unless the counterclaim is undisputed, has been stated as legally binding or is ready for decision.

11. Liability for compensation (limitations and exclusions)

11.1 If essential contractual obligations - major obligations whose fulfilment allows the proper execution of the contract and on whose fulfilment the ordering party may rely - are breached, we shall also be liable in the event of simple negligence; however, any claims are limited to compensation for damages which were foreseeable and typical of the contract at the time of the contract conclusion.

11.2 Otherwise - unless the breach of an essential contractual obligation is concerned and subject to the following Paragraph 11.4 - our liability for compensation shall be limited to damages resulting from a grossly negligent breach of duty on the part of our legal representatives or agents, regardless of the legal grounds and including an unlawful act, insofar as this involves culpability. Indirect damages or damages resulting from defects to the delivery item are only eligible for compensation if such damages are typically expected from the intended use of the delivery item.

11.3 The aforementioned liability exclusions and limitations shall apply to the same extent in favour of our bodies, legal representatives, employees and other agents.

11.4 The aforementioned liability exclusions and limitations shall not apply for damages as a result of injury to life, limb or health based on a negligent breach of duty on our part or an intentional or negligent breach of duty on the part of our legal representatives or agents. Similarly, claims from a warranty or according to the Product Liability Act shall not be affected by this.

12. Place of performance, competent court of jurisdiction and applicable law

12.1 Place of performance is the location of our supplying factory.

12.2 The place of jurisdiction for contracts with merchants, legal entities under public law and separate funds under public law is the registered office of the Bals contracting company. We reserve the right, however, to take action against the ordering party before the competent courts for his registered office.

12.3 For all deliveries and services from German Bals companies, German law shall apply for transactions within the EU with the exception of the UN Convention on the International Sale of Goods; the UN Convention on the International Sale of Goods shall apply for international transactions with companies outside of the EU along with German law if the former does not contain any appropriate regulations. For Bals companies which are not based in Germany, the respective law in that country shall apply, with the UN Convention on the International Sale of Goods taking priority.

(Published in January 2019)

 made
in
Germany



Simply. Well. Connected.

霸士电器（昆山）有限公司
Bals Elektrotechnik (Kunshan) Co Ltd

地 址:江苏省昆山市郁金香路雄鹰路301号

Add: 301 Xiongying Road, Kunshan, Jiangsu Province

Tel: +86 - 512 - 86167886 - 111

Fax: +86 - 512 - 86167880

<http://www.bals.com.cn>